



॥ सरस्वती नः सुभगा भवस्वत ॥
U. P. RAJARSHI TANDON
OPEN UNIVERSITY

CFS-01

(Certificate Course in Forensic Science)

**FORENSIC SCIENCE, CRIME SCENE,
MANAGEMENT, QUESTIONED
DOCUMENTS AND FINGER PRINTS**

Block-1

FUNCTIONS OF FORENSIC SCIENCE AND CRIME SCENE MANAGEMENT

- UNIT 1 DEFINITIONS AND CONCEPTS OF FORENSIC SCIENCE
 - UNIT 2 TOOLS AND TECHNIQUES
 - UNIT 3 CRIME SCENE INVESTIGATION
 - UNIT 4 TYPES, SIGNIFICANCE AND CLASSIFICATION OF PHYSICAL AND TRACE EVIDENCES
-

Block-2

QUESTIONED DOCUMENTS AND FINGERPRINTS

- UNIT 5 SCOPE, DEVELOPMENT, DEFINITION AND NATURE OF QUESTIONED DOCUMENTS
 - UNIT 6 DEVELOPMENT OF INDIVIDUALITY IN HANDWRITING
 - UNIT 7 FORGERIES AND LINE QUALITY DEFECTS
 - UNIT 8 FUNDAMENTALS AND PRINCIPLES OF FINGERPRINTING
-



॥ सरस्वती नः सुभगा भवस्वतः ॥
U. P. RAJARSHI TANDON
OPEN UNIVERSITY

CFS-01

(Certificate Course in Forensic Science)

**FORENSIC SCIENCE, CRIME SCENE,
MANAGEMENT, QUESTIONED
DOCUMENTS AND FINGER PRINTS**

Block

1

FUNCTIONS OF FORENSIC SCIENCE AND CRIME SCENE MANAGEMENT

UNIT 1	5
DEFINITIONS AND CONCEPTS OF FORENSIC SCIENCE	
UNIT 2	12
TOOLS AND TECHNIQUES	
UNIT 3	25
CRIME SCENE INVESTIGATION	
UNIT 4	32
TYPES, SIGNIFICANCE AND CLASSIFICATION OF PHYSICAL AND TRACE EVIDENCES	

Course Design Committee

Dr. P. P. Dubey Director, School of Agri. Sciences, UPRTOU, Allahabad	Coordinator
Dr. A. K. Gupta Dean, SHIATS, Deemed University, Naini, Allahabad	Member
Dr. H. C. Jaisawal Consultant UPRTOU, Allahabad	Member
Dr. Gurvinder Kaur Associate Professor Forensic Science Unit, Department of Chemistry Sri Guru Tegh Bahadur Khalsa College, University of Delhi, Delhi-110007	Member
Dr. G. S. Sodhi Associate Professor Forensic Science Unit, Department of Chemistry Sri Guru Tegh Bahadur Khalsa College, University of Delhi, Delhi-110007	Member
Dr. Vimal Rarh Assistant Professor Forensic Science Unit, Department of Chemistry Sri Guru Tegh Bahadur Khalsa College, University of Delhi, Delhi-110007	Member
Dr. Santosha Kumar Associate Professor School of Social Sciences, UPRTOU, Allahabad	Member
Dr. Shruti Assistant Professor School of Sciences, UPRTOU, Allahabad	Member Secretary
Dr. G K Diwedi Assistant Professor School of Education, UPRTOU, Allahabad	Member
Faculty Members, School of Sciences	
Dr. Ashutosh Gupta , Director, School of Science, UPRTOU, Prayagraj	
Dr. Shruti, Asst. Prof. , (Statistics), School of Science, UPRTOU, Prayagraj	
Ms. Marisha, Asst. Prof. , (Computer Science), School of Science, UPRTOU, Prayagraj	
Mr. Manoj K Balwant , Asst. Prof., (Computer Science), School of Science, UPRTOU, Prayagraj	
Dr. Dinesh K Gupta , Academic Consultant (Chemistry), School of Science, UPRTOU, Prayagraj	
Dr. Vikas Singh , Academic Consultant (Maths), School of Science, UPRTOU, Prayagraj	
Dr. Dharamveer Singh , Academic Consultant (Bio-Chemistry), School of Science, UPRTOU, Prayagraj	
Dr. R.P. Singh , Academic Consultant (Bio-Chemistry), School of Science, UPRTOU, Prayagraj	
Dr. Susma Chuhan , Academic Consultant (Botany), School of Science, UPRTOU, Prayagraj	
Dr. Deepa Chaubey , Academic Consultant (Zoology), School of Science, UPRTOU, Prayagraj	

Course Preparation Committee

Dr. G. S. Sodhi Associate Professor Forensic Science Unit, Department of Chemistry Sri Guru Tegh Bahadur Khalsa College, University of Delhi, Delhi-110007	Author
Dr. Gurvinder Kaur Associate Professor Forensic Science Unit, Department of Chemistry Sri Guru Tegh Bahadur Khalsa College, University of Delhi, Delhi-110007	Editor
Dr. Vimal Rarh Assistant Professor Forensic Science Unit, Department of Chemistry Sri Guru Tegh Bahadur Khalsa College, University of Delhi, Delhi-110007	Member

September, 2019

© Uttar Pradesh Rajarshi Tandon Open University.

ISBN 978-93-83328-08-6

All Rights are reserved. No part of this work may be reproduced in any form, by mimeograph or any other means, without permission in writing from the **Uttar Pradesh Rajarshi Tandon Open University**.

Printed and Published by Dr. Arun Kumar Gupta, Registrar, **Uttar Pradesh Rajarshi Tandon Open University, 2018.**

Printed By : Chandrakala Universal Pvt Ltd. 42/7 Jawahar Lal Neharu Road Allahabad-211002

UNIT-1 : DEFINITIONS AND CONCEPTS OF FORENSIC SCIENCE

Structure

- 1.0 Introduction
- 1.1 Objectives
- 1.2 Basic Principles of forensic science
 - 1.2.1 Locard's principle of exchange
 - 1.2.2 Newton's law of universal gravitation
- 1.3 History and Development of forensic Science of India
- 1.4. Summary

1.0. INTRODUCTION

The study of evidence discovered at a crime scene and used in a court of law. Forensic science is any science used for the purposes of the law, and therefore provides impartial scientific evidence for use in the courts of law, and in a criminal investigation and trial. Forensic science is a multidisciplinary subject, drawing principally from chemistry and biology, but also from physics, geology, psychology, social science, etc.

Examples of forensic science include the use of gas chromatography to identify seized drugs, DNA profiling to help identify a murder suspect from a bloodstain found at the crime scene, and spectroscopy to identify microscopic paint fragments.

1.1 OBJECTIVES

- Recollect basic principles underlying Forensic Science
- Various developments in the field of forensic science

1.2 BASIC PRINCIPLES OF FORENSIC SCIENCE

Forensic Science is the application of a broad spectrum of sciences to the court of Law. This may be in relation to a crime or a civil action. The word *forensic* comes from the Latin *forensis*, meaning "of or before the forum." In Roman times, a criminal charge meant presenting the case before a group of public individuals in the forum. Both the person accused of the crime and the accuser would give speeches based on their sides of the story. The individual with the best argument and delivery would determine the outcome of the case. This origin is the source of the two modern usages of the word *forensic* – as a form of legal evidence and as a category of public presentation.

In modern use, the term "forensics" in the place of "forensic science" can be considered correct as the term "forensic" is effectively a synonym for "legal" or "related to courts". However the term is now

so closely associated with the scientific field that many dictionaries include the meaning that equates the word "forensics" with "forensic science".

1.2.1 Locard's Principle of Exchange

Forensic science owes its origins first to those individuals who developed the principles and techniques needed to identify or compare physical evidence, and second to those who recognized the necessity of merging these principles into a coherent discipline that could be practically applied to the criminal justice system.

It was Locard's belief that when a criminal comes into contact with an object or person, a cross-transfer of physical evidence occurs. This is known as Locard's Exchange Principle. For example, Locard strongly believed that every criminal could be connected to a crime by dust particles carried from the crime scene. By recognizing, documenting, and examining the nature and extent of this evidentiary exchange, Locard observed that criminals could be associated with particular locations, items of evidence, and victims. The detection of the exchanged materials is interpreted to mean that the two objects were in contact. Forensic scientists also recognize that the nature and extent of this exchange can be used not only to associate a criminal with locations, items and victims, but with specific actions as well.

1.2.2 Newton's law of universal gravitation

It states that every point mass in the universe attracts every other point mass with a force that is directly proportional to the product of their masses and inversely proportional to the square of the distance between them. This is a general physical law derived from empirical observations by what Newton called induction. When applied to forensic science, the law of gravitation dictates that the greatest probability of finding crime scene evidence is on the floor or the ground of a crime scene. The forensic scientists should concentrate on these areas most for locating physical and trace evidence.

1.3 HISTORY AND DEVELOPMENT OF FORENSIC SCIENCE IN INDIA

The application of science and technology to the detection and investigation of crime and administration of justice is not new to India. Although our ancestors did not know forensic science in its present form, scientific methods in one way or the other seem to have been followed in the investigation of crime. Its detailed reference is found in Kautilya's *Arthashastra*, which was written about 2300 years ago. Indians studied various patterns of the papillary lines on hands and fingers, thousands of years ago. It is presumed that they knew about the persistency and individuality of fingerprints, which they used as signatures. The Indians knew for long that the handprints, known as the Tarija', were inimitable. The use of fingerprints as signatures by illiterate people in India, introduced many centuries ago, was considered by Europeans as ceremonial only, till it was scientifically proved that identification from fingerprints was infallible.

Chemical examiner's laboratories

During the nineteenth century, when the cases of death due to poisoning posed a problem to the law enforcement agencies, a need was felt for isolating, detecting and estimating various poisons absorbed in the human system. The first Chemical Examiner's Laboratory was, therefore, set up for this purpose at the then Madras Presidency, under the Department of Health, during 1849. Later, similar laboratories were set up at Calcutta (1853), followed by one each at Agra (1864) and Bombay (1870). These laboratories were equipped to handle toxicological analysis of viscera, biological analysis of stains of blood, semen, etc. and chemical analysis of food, drugs, and various excisable materials to provide scientific support to the criminal justice delivery system within their limited means.

Anthropometric bureau

With the introduction of Photography, the Criminal Investigation Department (CID) maintained records of every known criminal including a detailed description of his appearance. With the invention of Bertillon's anthropometric system in 1878, India, along with the other countries of the world, adapted Bertillon's system of personnel identification and thus an Anthropometric Bureau, for maintaining anthropometric records of criminals, was established in 1892 at Calcutta.

Finger print bureau

William Herschel, the Collector of the District of Hooghly (Bengal) found that markings on the fingertips of a person never changed during his lifetime. Herschel applied his knowledge and skill in devising a system of registration of finger or thumb impressions of native contractors to safeguard the interests of the Government against the repudiation of contracts by them. Thereafter, he extended his registration procedure to prison regulations for identifying convicted criminals. In 1877, Herschel sought the consent of his superior officers in putting his ideas into practice, but did not succeed. In 1891, Edward Richard Henry's appointment, as the Inspector General of Police in Bengal, introduced the thumb impressions in the record slips, containing anthropometric data, to avoid wrong identification. Long before 1897, he introduced maintenance of criminal records on the basis of impressions of 10 fingers, as well as the anthropometric data.

Henry employed few selected Indian police officers, viz. Khan Bahadur AzizulHuq and Rai Bahadur Hem Chandra Bose to work under his general supervision till a classification system of fingerprint record evolved; it remains in force even today. It was Khan Bahadur AzizulHuq who evolved a mathematical formula to supplement Henry's idea of sorting slips in 1024 pigeon holes, based on fingerprint patterns. RaiBahadur Hem Chandra Bose made further contribution to the fingerprint science by evolving an extended system of sub-classification, a telegraphic code for finger impression and a system of single fingerprint classification.

Henry approached the Government to seek approval for replacing the anthropometric data by fingerprints for the identification of habitual criminals. The Government readily agreed, and the first fingerprint bureau in the world was officially declared open at Calcutta in July 1897, although the collection of record slips had started a few years earlier. Thus, the personnel identification solely on the basis of fingerprints commenced in India.

Department of explosives

When the use of explosives for subversive activities became common, it was found necessary to detect the causes of explosion, either accidental or intentional. The foundation of the Department of Explosives was laid when the first chief inspector of explosives was appointed in the year 1898, with his headquarters at Nagpur. Later, five regional offices were opened. They developed competence to provide scientific clues in respect of explosives as well as the possible causes of explosions.

Government examiner of questioned document, Shimla

The British Government of Bengal felt the necessity of identifying the handwritings on the secret documents connected with the Indian independence movement and, therefore, created the post of Government Handwriting Expert of Bengal. Mr. C.R.Hardless, the then Superintendent in the A.G.'s office in Bengal, was appointed to this post in 1904. This set-up was shifted to Shimla in the year 1906 and was placed under the control of the Director, CID. A post of Handwriting Expert for the Government of India was created to which Mr. C.R.Hardless. He was replaced by Mr. F Brewster, a police officer from the West Bengal CID, and was designated as the Government Examiner of Questioned Documents (GEQD). At first, the work of this office was mainly confined to the identification of writings on secret documents. Later, as the application of this branch of science was felt in many other cases, the services of this office were thrown open to criminal as well as civil court cases. During the World War II, this organization took up the additional work of secret censorship, including the detection of invisible writings and training of military personnel in this field of science.

Serologist to the government of India

When the science of examining human blood developed in India, it became possible to examine blood and seminal stains in criminal investigations. Realizing the importance of Forensic Serology, an institute named as 'Serology Department' was established in Calcutta in 1910. The head of this institute was designated as Imperial Serologist to the Government of India. Dr. Hankin helped in establishing this department. Though the scientific techniques for serological examination were at the infancy stage, this institute provided valuable scientific support by analyzing biological materials for crime investigations.

Footprint section of criminal investigation department

During the year 1915, a Footprint Section was established under the CID, Government of Bengal, which helped the police authorities to identify criminals through the examination of footprints collected from the scene of crime. S.M. Edwardes recorded the following instance in his book *Bombay City Police* showing the use of the footmarks in police work. 'On several occasions, Indian constables distinguished themselves by acts of bravery and examples of professional acumen. The detection of a burglary in the showroom of an English firm was entirely due to the action of a Hindu constable, who noticed on a piece of furniture the marks of a foot possessing certain peculiarities, which he remembered having seen before in the foot of an ex-convict.'

Note forgery section in criminal investigation department

During 1917, a Note Forgery Section was set up under the CID, Government of Bengal, to undertake the examination of forged currency notes. The Revenue Department also started its own laboratory

for identification of opium and narcotics, liquor analysis and estimation of purity levels of precious metals like gold, silver, etc. Similarly, Government Mint and Security Printing Departments at Nasik also established their own laboratories for detecting cases of counterfeit and forged currency notes.

Ballistics laboratory

In 1930, an Arms Expert was appointed and a small ballistic laboratory was set up under the Calcutta Police to deal with the examination of firearms. As the menace of firearms grew, other State CIDs also established small ballistics laboratories to help them in the criminal investigation.

Scientific sections in the criminal investigation department

During 1936, a Scientific Section was set up under the CID in Bengal and facilities were created for examination of bullets, cartridge cases, firearms, etc., used in committing crime. Few other states also started scientific sections in their CID, where investigations on fingerprints, footprints, firearms and questioned documents were also carried out. Gradually, more and more branches of science were embraced and the laboratories gained maturity over the years.

State forensic science laboratory, Calcutta

The first state forensic science laboratory in India was established in the year 1952 at Calcutta. This laboratory became fully operational in the year 1953. The Medico-legal Section of the Chemical Examiner's Laboratory was also transferred to this laboratory. During the year 1955, a small unit of Physics was established in the West Bengal State Forensic Science Laboratory to deal with various physical examinations of exhibits encountered in crime investigation. During the year 1957, the Physics unit developed into a full-fledged Physics Section. In the same year, the Footprint and the Note Forgery Sections of Criminal Investigation Department were transferred to this laboratory and in the following year General Chemistry Section of the Chemical Examiner's Laboratory was also transferred to this laboratory. Thus the first multidisciplinary forensic science laboratory came into existence in the country.

Central finger print bureau

On the recommendations of the Royal Police Commission of 1902-03, the first Central Finger Print Bureau (CFPB) in India was established in 1905 at Simla. It, however, suffered a setback and was abolished in 1922 as a result of retrenchment proposals of the Incharge Committee. The CFPB restarted functioning from 1955 in Delhi under the administrative control of Intelligence Bureau (IB). The major role envisaged for CFPB was to coordinate the activities of State Fingerprint Bureaus in tracing/locating inter-state criminals. During August 1956, the CFPB was shifted to Calcutta and remained under the administrative control of IB. During September 1973, it was transferred to the Central Bureau of Investigation and during July 1986, the administrative control of the CFPB was transferred to the National Crime Records Bureau (NCRB) and was again shifted to New Delhi.

Central detective training school at Calcutta

Central Detective Training School, Calcutta, a premier detective training school in India, was established during 1956 and was co-located (in the same premises) with the CFPB, Calcutta. The aim of establishing such a school was to impart training in scientific investigation of crimes like drug abuse, terrorism, explosion, crime against women, investigation of road accidents and enforcement of traffic laws, etc.

Central forensic science laboratories

The first Central Forensic Science Laboratory (CFSL) was established at Calcutta during 1957. To begin with, this laboratory was organised into four basic disciplines viz. Forensic Physics, Forensic Chemistry, Forensic Biology and Forensic Ballistics. For application of nuclear methods of analysis to criminal investigation, the Neutron Activation Analysis Unit of CFSL, Calcutta was set up in 1970 at the Bhabha Atomic Research Centre, Trombay. In the year 1965, the second central forensic science laboratory was established at Hyderabad, with analytical facilities in the disciplines of Forensic Physics, Forensic Chemistry and Forensic Biology. The Central Forensic Science Laboratory, Chandigarh, was originally set up at Lahore in 1933, and was later shifted to Chandigarh in 1961. Over the years many full-fledged forensic science laboratories were established in various states.

Central forensic institute, Calcutta

With the establishment of CDTS and CFSL, (later on GEQD also) in the same premises, under the control of Intelligence Bureau, the whole set up was named as the Central Forensic Institute (CFI), Calcutta. A post of Commandant was created during 1958 to look after the overall functioning of all these establishments, which had different roles but with the common broad goal of providing appropriate scientific inputs to the criminal investigation process and administration of criminal justice in the country.

CDTS at Hyderabad & Chandigarh

The Central Detective Training School, Hyderabad was established in 1964, on the pattern of the CDTS, Calcutta, followed by another one at Chandigarh, during 1973. Their main objective was to train the operational police personnel in modern scientific techniques of crime investigation, with a view to improve their professional standard and efficiency.

Establishment of DNA typing laboratory at CFSL Calcutta

In response to the rising demands of providing sophisticated technology to the crime investigation process, the Bureau of Police Research and Development (BPR&D) established the first Forensic DNA Typing facility at CFSL, Calcutta, during 1998. The implementation of this state-of-the-art technique represents significant advancements in the forensic biology in the country. The DNA Typing Unit at CFSL Calcutta is equipped with the latest techniques like, Polymerize Chain Reaction (PCR), HLADQ alpha and Polymarker, and Locus Specific Restricted Fragment Length Polymorphism. This laboratory, after being functional, has been referred many crime cases pertaining to murder, rape, rape and murder, paternity disputes, organ transplant, exchange of babies in hospitals etc. DNA Typing facility has further been upgraded to conduct 'Short Tandem Repeats Sequence based DNA Typing.

CHECK YOUR PROGRESS

1. What is Forensic Science?
2. Define Locard's Principle of Exchange.
3. Give some milestones in the development of forensic science in India

1.4 SUMMARY

In this unit, we have introduced the basics of Forensic science. We have define various terms related to Forensic science and have also explained various fundamental principles of forensic science. Numerous milestones in the development of the forensic science in India were also highlighted in this unit. These concepts are essential to lay the foundation for the course.

UNIT - 2 : TOOLS AND TECHNIQUES

Structure

- 2.0 Introduction
- 2.1 Objectives
- 2.2 Tools and techniques in forensic science
 - 2.2.1. Hand lens
 - 2.2.2. Vernier Calliper
 - 2.2.3. Stereo-zoom microscope
 - 2.2.4. Comparison microscope
 - 2.2.5. Abbe's refractometer
 - 2.2.6. Spectroscopy
 - 2.2.7. Electrophoresis
 - 2.2.8. DNA profiling
 - 2.2.9. Automated Fingerprint Identification System
 - 2.2.10. Electrostatic Detection Apparatus
 - 2.2.11. Facial Reconstruction
 - 2.2.12. Lie detection
 - 2.2.13. Functional Magnetic Resonance Imaging
 - 2.2.14. Narco analysis
- 2.3 Branches of forensic science
 - 2.3.1. Biology division
 - 2.3.2. Serology division
 - 2.3.3. Physics division
 - 2.3.4. Ballistic division
 - 2.3.5. Document division
 - 2.3.6. Chemistry division
 - 2.3.7. Fingerprint division
 - 2.3.8. Lie-Detection division
 - 2.3.9. Photography division
- 2.4 Organizational Structure of Forensic Science Laboratories
- 2.5 Summary

2.0 INTRODUCTION

There are numerous tools and techniques in forensic science, which can be applied to solve a criminal case. When forensic scientists arrive at a crime scene, they have a tough job ahead of them. Luckily, the scientists come armed with a range of tools to help them identify and analyze even the tiniest fragment of evidence. Different branches of forensic laboratory deal with different cases pertaining to their specialty. After the preliminary analysis of the recovered evidences at the scene of the crime, samples are taken to the forensics laboratory and sent in the respective branches, where even more powerful equipment can be used to decipher the clues.

2.1 OBJECTIVES

- Define and describe various tools and techniques employed by forensic scientists.
- Elaborate on different branches of Forensic Science
- Understand the organizational structure of forensic science laboratories in India

2.2. TOOLS AND TECHNIQUES IN FORENSIC SCIENCE

2.2.1. Hand lens

- Basic magnifier
- Provides relatively high magnification of a small area rather than low magnification of a large area
- Available in various magnifications depending upon the area of need

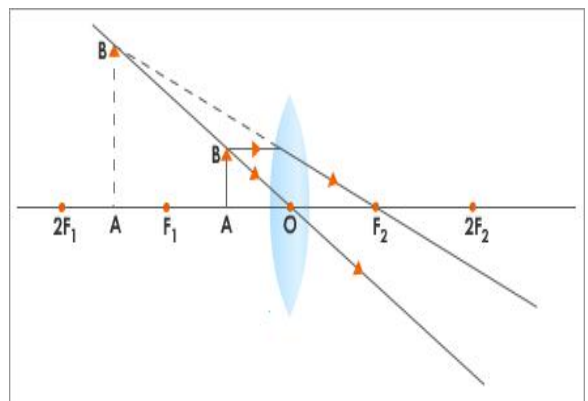

Technique

It works by creating a magnified virtual image of an object behind the lens. The distance between the lens and the object must be shorter than the focal length of the lens for this to occur. Otherwise, the image appears smaller and inverted.

It is a very useful tool for forensic experts in studying documents, fingerprints and many other evidences where magnification is required.

2.2.2 Vernier calipers

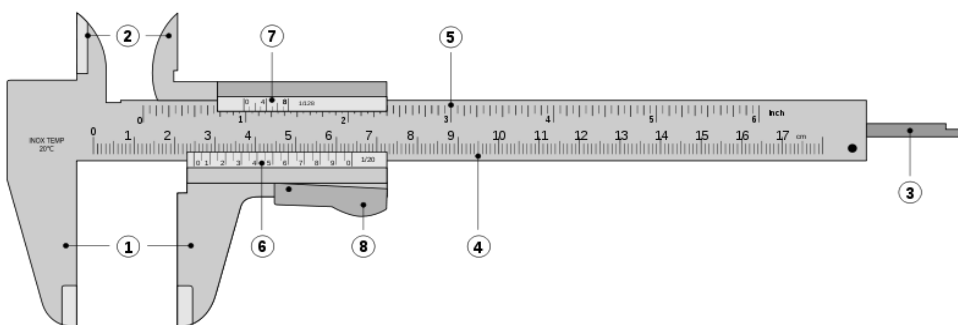

Parts

1. **Outside jaws:** used to measure external diameter or width of an object
2. **Inside jaws:** used to measure internal diameter of an object

3. **Depth probe:** used to measure depths of an object or a hole
4. **Main scale:** gives measurements of up to one decimal place (in cm).
5. **Main scale:** gives measurements in fraction (in inch)
6. **Vernier** gives measurements up to two decimal places (in cm)
7. **Vernier** gives measurements in fraction (in inch)
8. **Retainer:** used to block movable part to allow the easy transferring a measurement

It measures the distance between two symmetrical opposing surfaces

Technique

1. Mark on the fixed scale is read.
2. Mark on the fixed scale that is adjacent to the zero mark is noted.
3. The ten marks on the Vernier and millimeter scale are noted until the two most nearly line up.
4. Final result is calculated by adding the three readings.

Firearm examiners use Vernier caliper for measuring the gauge of weapons.

2.2.3. Stereo zoom microscope

- It has a set of two eyepieces and works like a telescope.
- It allows viewing of specimens with both the eyes and getting accurate view of its surface.
- The significant advantage of stereoscopic microscope is that by using two optical systems, and erect image of the object can be seen in 3 dimensions in the field of view with high resolution.



- It allows the viewer to adjust its magnification levels without removing his or her eyes from the eyepieces.
- It allows visualizing the object in 3 dimensions. This can be done when our eye see the object with slightly different angels.

Technique

The light bundle, which gives origin to the two light bundles seen by the eyes, passes through the same objective. Four prisms placed between the common objective and the binoculars splits the original bundle into two equal parts and direct them to the objectives of the binoculars.

Binoculars are made to observe the distant objects and the light from the object, which enters into the objective, is practically parallel. Each objective of the binocular forms an image at its focal distance from the sample so the light, which emerges from the objective, is parallel as if the object was placed at infinity. So the objective of the binocular focuses the separate images of the sample in the focal planes of their eyepieces. The eyepiece magnifies the image and supplies it to the observer.

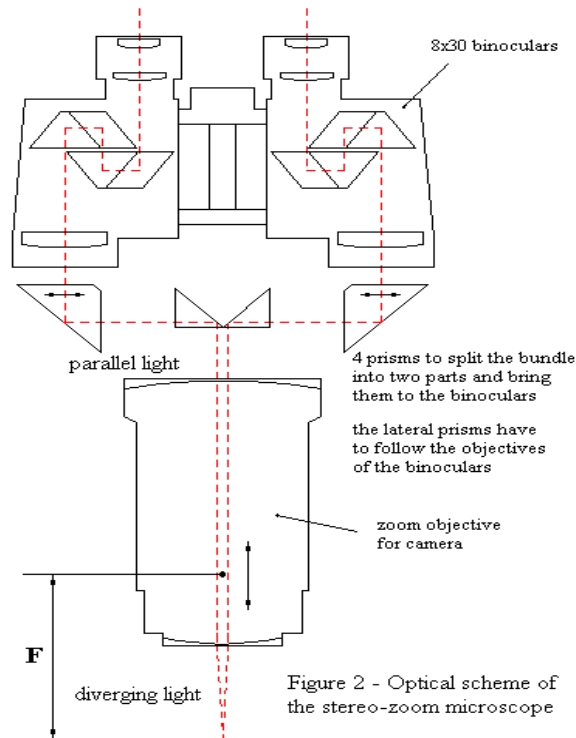

2.2.4. Comparison microscope

A comparison microscope is used to analyze side-by-side specimens. It consists of two microscopes connected by an optical bridge. The left side of the view field is the image produced by the left microscope, and the right side of the view field is the image produced by the right microscope.

The comparison microscope is used in forensic science to compare microscopic patterns and identify or deny their common origin. Items that are commonly observed under the comparison microscope are fired bullets, fired casings, and tool marks. Other evidence, including impressions of serial numbers or characters from a typewriter, can also be compared using the comparison microscope



2.2.5. Abbes refractometer

The Abbe refractometer provides a quick and easy means for determining refractive index and dispersion of liquids and solids. It is used in the examination of organic compounds (oils, solvents, etc.), solutions, food products, and serum protein concentration.



2.2.6. Spectroscopy

Spectroscopy pertains to the dispersion of an object's light into its component colors (i.e. wavelengths). Spectroscopy is the study of the interaction between radiation (electromagnetic radiation, or light, as well as particle radiation) and matter.

- Ultraviolet-visible spectroscopy
- Infrared spectroscopy (IR spectroscopy)
- Atomic absorption spectroscopy (AAS)
- Atomic emission spectroscopy (AES)

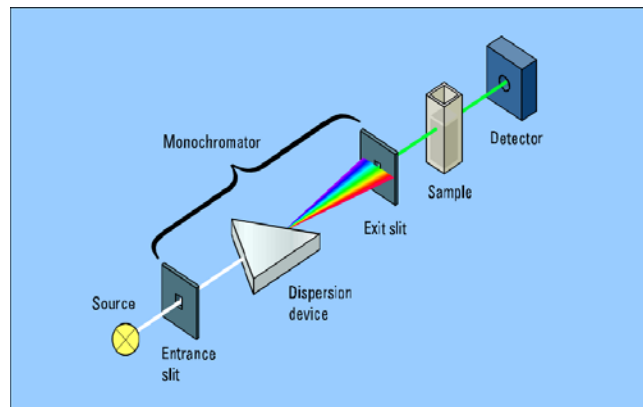

2.2.7. Electrophoresis

Gel electrophoresis is a technique used for the separation of DNA, RNA, or protein molecules using an electric current applied to a gel matrix. DNA is negatively charged so it runs towards the positive end while separating the DNA according to size.

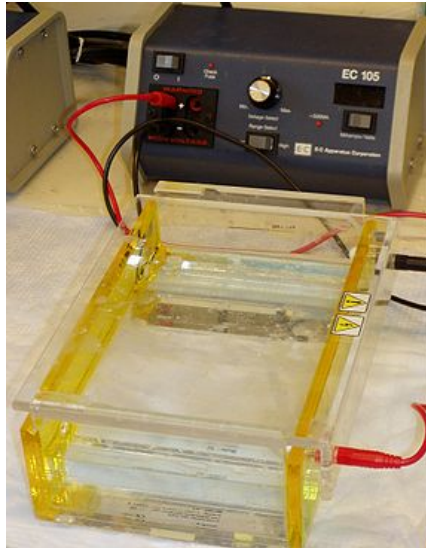

2.2.8. DNA Profiling

DNA profiling (also called DNA testing, DNA typing, or genetic fingerprinting) is a technique employed by forensic scientists to assist in the identification of individuals on the basis of their respective DNA profiles.

DNA profiling process

1. Polymerase chain reaction (PCR).
2. A DNA sequencer

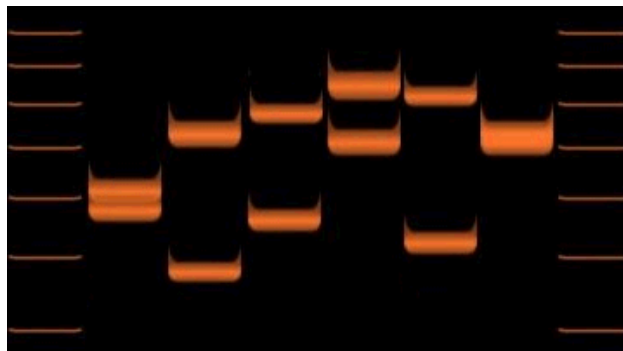

2.2.9. Automated Fingerprint Identification System (AFIS)

Automated fingerprint identification is the process of automatically matching one or many unknown fingerprints against a database of known and unknown prints. Automated fingerprint identification systems are primarily used by law enforcement agencies for criminal identification initiatives, the most important of which includes identifying a person suspected of committing a crime or linking a suspect to other unsolved crimes.

2.2.10. Electrostatic Detection Apparatus (ESDA)

Used to detect and to assist in the decipherment of indented impressions of handwriting on paper.



Muslim Education Centre		
No.	Description	Amount
1	Twenty lessons for Muslim Women	
1	Contemporary Fatawa	
1	Women who deserve to go to hell	
1	Islam - choice of thinking women	
1	Aqulabel Islam	
1	Islam & Maternity	
1	Women in Islamic Sharia	
Paid Cash.		
M. Hussein		
8-10-2007		
Total		£82-46

Tottenham Drive, High Wycombe, HP12 6JH
Receipt from the Muslim Education Centre in High Wycombe



...an ESDA test on the receipt reveals that it was filled in while resting on top of another receipt

Technique

The sheet of paper is placed on the ESDA and a thin plastic film is placed over it. The two are held in close contact by means of vacuum suction. The surface of the plastic film carries an electrostatic charge. The surface of the paper causes a different pattern of charging in those areas where there are indentations. This charge difference is visualized by applying an oppositely charged black toner. The result is that toner tends to adhere to those areas corresponding to indentations. A sticky, transparent plastic film is placed across the ESDA trace to preserve it.

2.2.11. Facial Reconstruction Technique

Forensic facial reconstruction (or forensic facial approximation) is the process of recreating the face of an unidentified individual from their skeletal remains through an amalgamation of artistry, forensic science, anthropology, osteology, and anatomy.

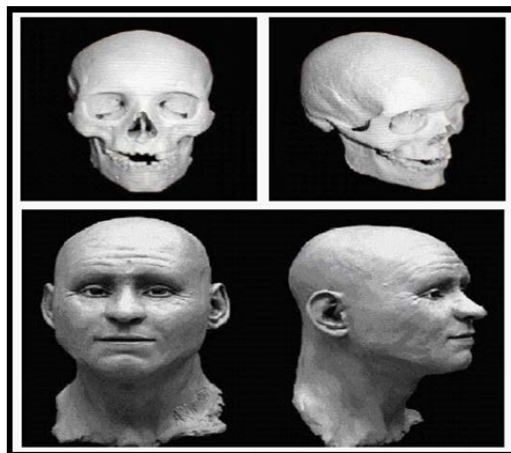

- Two-dimensional facial reconstructions
- Three-dimensional facial reconstructions
- Superimposition

2.2.12. Lie Detection

- Lie detection is the practice of determining whether someone is lying.
- It is an examination which is based on an assumption that there is an interaction between the mind and body.

Polygraph

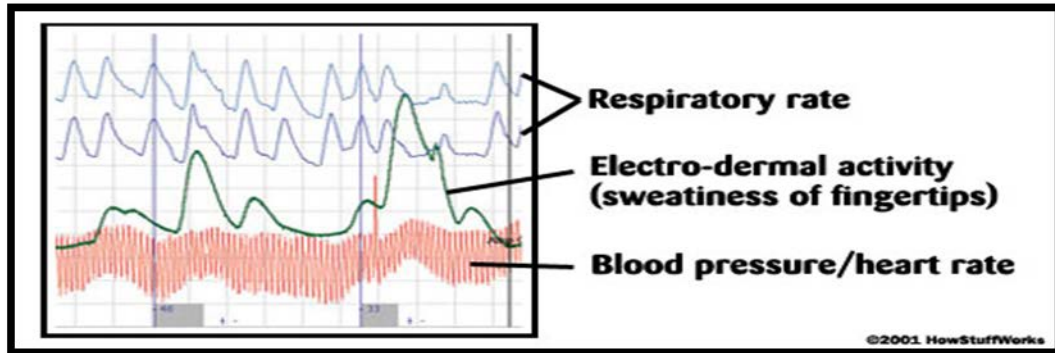

2.2.13 Functional Magnetic Resonance Imaging



Brain Observations Electroencephalography is used to detect changes in brain waves. Truth drugs such as sodium thiopental are used for the purposes of obtaining accurate information from an unwilling subject

2.2.14. Narco Analysis

The Narcoanalysis test takes the subject from normal state to semi-conscious state and neutralizes his imagination. In the semi-conscious state, it becomes difficult for him to lie and his answers would be restricted to facts he is already aware of. The subject is not in a position to speak up on his own but can answer specific but simple questions.



2.3 BRANCHES OF FORENSIC SCIENCE

The study of Forensic sciences has been divided into various divisions depending on the science discipline it is related to as follows:

2.3.1. Biology Division

- Identification of blood, menstrual blood, semen, saliva, sweat, urine, vomit, fecal matter, nasal discharge etc. and their stains.
- Identification of different parts of animal and human tissues.
- Identification, origin and comparison of hair. Remarks whether the hair is naturally fallen, forcibly removed, hammered, cut or burnt etc.
- Identification and comparison of all types of fibres, including wool.
- Determination of origin, sex, age, height & identity etc. from skeletal remains, including teeth.
- Anthropometric comparison of human skull with photograph before finally attempting the superimposition technique for human identification.

2.3.2. Serology Division

- Identification of species of origin from fresh liquid blood and bloodstains.
- Identification of species of origin from tissue, skin, both fresh and old, muscles and bone pieces having bone marrow.
- Identification of species of origin from washed bloodstains.
- ABO grouping of fresh blood (both from cells and serum) and bloodstains.
- ABO grouping of semen, saliva, vomit and other body fluids as well as their stains.
- ABO grouping of mixed diluted and washed bloodstains.
- ABO grouping of blood and semen mixed and other body fluid mixed stains.
- ABO grouping of tissue, skin, muscles, nail clippings and bone fragment.
- Identification of species of origin and ABO grouping from hair having fresh root follicles.
- Identification of species of origin and ABO grouping of blood and semen stains having fats and any other material adhering to it.
- Identification of species of origin and ABO grouping of older blood, semen and saliva stains.

2.3.3. Physics Division

- Examination of paints, glass, metal, including medals, coins etc.
- Examination and comparison of tool/cut marks on metals, clothes, paper, leather, glass etc.
- Examination of telegraphs wires.
- X-ray radiographic examination of packets, boxes, letter bombs & other secret contrabands as well as currency notes, lottery tickets etc.
- Deciphering of erased/altered numbers on automobiles, cycles, machines, typewriters, firearms and tailor marks.
- Testing and comparison of sealing waxes, stones, statues, electrical wires, machines, motor parts, electric motors, stoves, refrigerators etc.
- Determination of cause of fire, whether due to electric short-circuiting or otherwise.
- Determination of direction of force on glass, door, windowpanes etc. in suicide/murder cases.
- Comparison of fabrics, buttons, soil, seals, printing blocks, printing material etc.
- Reconstruction of scene of crime.
- Comparison and recognition of recorded voice.

2.3.4. Ballistics Division

- Identification & comparison of bullets, cartridges, cartridge cases, etc. recovered from the scene of crime or the body of the victim.
- Estimation of the range, direction and angle of firing.
- Examination of air guns and country-made/non-standard firearms for their performance and measurement of their muzzle velocities to check their lethality.
- Analyses of live explosive of traces of explosive-residues in post explosion debris to determine the type of explosive involved.
- Identification of explosives and examination of defused/ exploded explosive devices (service/individual/improvised) to determine their operation and origin.

2.3.5. Documents Division

- Identification of handwriting and signatures.
- Detection of forgeries in signatures
- Examination of typewriting and identification of typewriter & typist.
- Analysis and comparison of inks and paper.
- Examination/comparison and decipherment of rubber seal impressions.
- Examination of handwriting on unusual surfaces at crime scenes, like wall, tree, wood log, mirror, lifts, curtains, weapons, dead body etc.
- Detection and decipherment of erased, altered, obliterated and indented writings.
- Examination and decipherment of writings between pasted documents, examination of adhesive and gums.
- Examination and comparison of printed, cyclostyled, photo and carbon copy writings and signatures
- Ascertaining the sequence of two intersecting strokes and folds on documents
- Reconstruction of charred and torn documents.
- Examination of staple pins/clip marks, punch holes etc. on documents.
- Examination of photocopies/Fax copies and computer printouts.
- Examination of computer printouts in regard to process of printing.

- Examination of carbon papers and writings thereon.
- Examination of counterfeit and genuine currency; Indian and foreign notes.
- Ascertaining the relative or absolute age of documents.
- Detection of forgeries in travel documents, like passports, traveller cheques, identity cards, credit cards, visas, driving licenses etc.
- Detection and decipherment of secret writings.

2.3.6. Chemistry Division

- Identification of poisons in biological materials (viscera, blood, urine, stomach wash, vomit etc.).
- Qualitative analysis of narcotics and psychotropic substances.
- Analysis of petroleum products and other inflammable substances in arson cases, including dowry deaths.
- Identification of phenolphthalein in trap cases.
- Acids and alkalis analysis.

2.3.7. Fingerprint Division

- Comparison of fingerprints on documents to establish their identity.
- Development and lifting of chance prints on exhibits received in the laboratory for examination or by visiting scene of crime in important cases and their comparison with the specimen fingerprints of the suspects/accused to establish their identity.
- Development of chance prints on documents, such as anonymous letters, threat letters, ransom letters and letters claiming the responsibility for terrorist acts by using modern chemical techniques.
- Development of chance prints from difficult surfaces using Laser Beam Technology and Polylight.
- Taking of ten-digit fingerprints of living persons.
- Preparation of fingerprint slips from the phalanxes.
- Comparison and identification of foot prints/footwear prints.

2.3.8. Lie Detection Division

The lie detection technique is based on the principle of psychosomatic interactions of an individual, i.e. a change in a person's consciously held feelings produces a psychological defense reaction in the form of physiological changes in his blood pressure, pulse rate, respiration and electro dermal response (GSR).

Fear of detection and entrapment induces a person to conceal the facts and this produces uncontrollable physiological reactions, which are precisely measured by the instrument called Polygraph. The Division provides the following facilities: –

- Verification of the statements of suspects, witnesses & complainants with the help of a Polygraph machine.
- To economise and accelerate the process of investigation by screening innocent persons where a large number of suspects are involved.
- Scientific interrogation of suspects in white-collar crime.
- Confirmation/corroboration of the findings of an investigation by Investigating Officers.

2.3.9. Photo and Scientific Aids Division (Forensic Photography):

- Photography and videography of scene of crime and crime-related exhibits/objects.
- Photography of accused/suspects.
- General & special photography involving ultraviolet, infra-red and visible radiations of all crime exhibits.
- Oblique light, transmitted light/sidelight photography to decipher indented writings/marks.
- Deciphering of processed photo films in damaged conditions.
- Secret photography involving I.R. and Telephoto lens techniques.
- Microphotography and macrophotography of documents, numerical, signatures, fingerprints etc.
- Photomicrography of blood, semen, hair, fibres etc.
- Identification of camera and allied equipment from the given photo films.
- Scientific Aids:
 - Secret tape recording of conversation under different conditions and its reproduction using special recording devices.
 - Secret recordings of telephone conversations.
 - Preparation of slides, pictures and posters and their projection for audio-visual display.
 - Preparation of audio/ video CDs.

2.4 ORGANIZATIONAL STRUCTURE OF FORENSIC SCIENCE LABORATORIES

Organizational Chart of CFSL

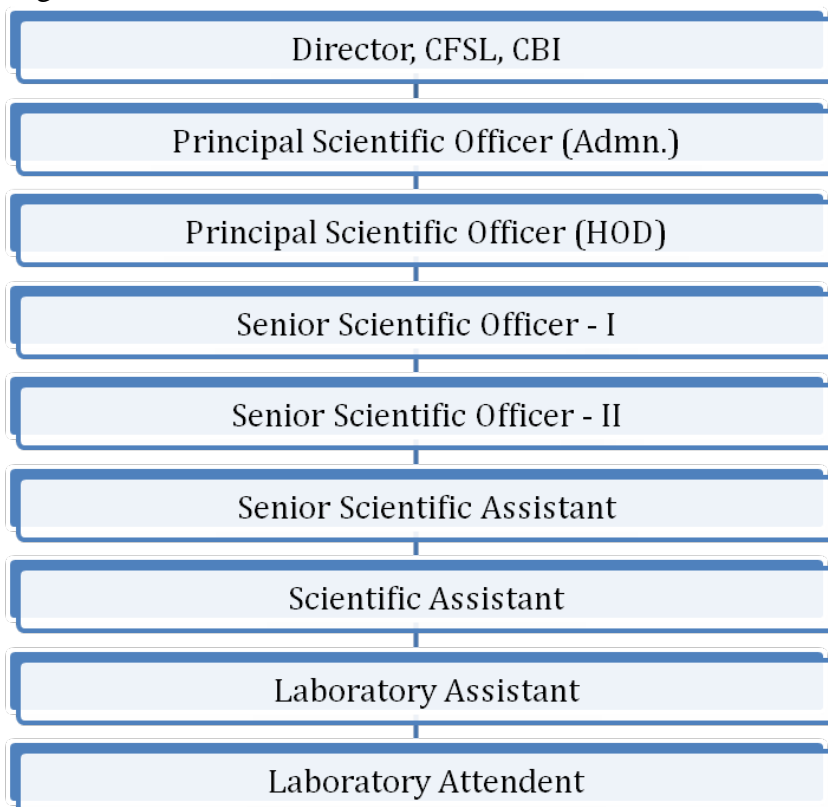

CHECK YOUR PROGRESS

- (I) Which of the following are branches of forensic science
- | | |
|----------------------------|-------------------------|
| 1) Ballistics | 3) Document examination |
| 2) Fingerprint examination | 4) All of these |
- (II) The process of recreating the facial features from skeletal remains is:
- | | |
|--------------------------|----------------------------|
| 1) Facial application | 3) Skeletal identification |
| 2) Facial reconstruction | 4) None of these |
- (III) Narco-analysis takes the mind of the subject from normal state to a:
- | | |
|-------------------------|------------------------|
| 1) Conscious state | 3) Sub conscious state |
| 2) Semi conscious state | 4) Unconscious state |

Answers

- (I) 4
(II) 2
(III) 2

2.4. SUMMARY

In this unit we have covered different tools and techniques deployed to collect and analyze the evidences recovered from the scene of crime. Understanding of the engagement of correct technique for evidence collection will enhance the investigative process. We also talked about different specialized branches of forensic science where in we send the concerned evidences collected from the scene of crime. This unit also throws some light on the hierarchy and the organization structure of forensic science laboratories in India.

UNIT - 3 : CRIME SCENE INVESTIGATION

Structure

- 3.0 Introduction
- 3.1 Objectives
- 3.2 Basics of Crime Scene Investigation
- 3.3 Protecting and isolating the Crime Scene
- 3.4 Documentation of crime scene by photography, sketching and field notes
- 3.5 Summary

3.0 INTRODUCTION

An Introduction to Crime Scene Investigation serves to eliminate warped impressions and to clearly identify and accurately explain the crime scene investigative process, components, methods, and procedure. The most important aspect of evidence collection and preservation is protecting the crime scene.

The goal of crime-scene documentation is to create a visual record that will allow the forensics lab and the prosecuting attorney to easily recreate an accurate view of the scene. The expert uses digital and film cameras, different types of film, various lenses, flashes, filters, a tripod, a sketchpad, graph paper, pens and pencils, measuring tape, rulers and a notepad at this stage of the investigation. He may also use a camcorder.

3.1 OBJECTIVES

Understand the importance of protecting the isolating the Crime scene.

- Follow the steps to Protect and isolate the scene of crime
- Document the scene of crime by employing various methods

3.2 BASICS OF CRIME SCENE INVESTIGATION

Before the investigators begin examining the scene of the crime, they should gather as much information as possible about the scene. Once again, a slow and methodical approach is recommended. Information is gathered to prevent destruction of valuable and/or fragile evidence such as shoeprints, trace evidence, etc. Once all of the information is gathered, a mental plan is formulated as to how the crime scene will be analyzed. Copious notes and relevant times should be kept on every aspect of the crime scene investigation. The examination of the scene will usually begin with a walk through of the area along the "trail" of the crime. The trail is that area, which all apparent actions associated with the crime, took place. The trail is usually marked by the presence of physical evidence. This may include the point of entry, the location of the crime, areas where a suspect may have cleaned up, and the point of exit. In some cases, a walk through may become

secondary if potential evidence is in danger of being destroyed. In that case, this evidence should be preserved, or documented and collected as quickly as possible.

The purpose of the walk through is to note the location of potential evidence and to mentally outline how the scene will be examined. The walk through begins as close to the point of entry as possible. The first place the investigators should examine is the ground on which they are about to tread. If any evidence is observed, then a marker should be placed at the location as a warning to others not to step on the item of interest.

A good technique to use indoors on hard floors is the oblique lighting technique (also known as side lighting). A good flashlight with a strong concentrated beam is the only tool needed. The room should be darkened as much as possible. If a light switch which a suspect may have touched needs to be turned off, then make sure the switch has been dusted for fingerprints first. Do not close any blinds or shades until after all general photographs have been taken. In the side lighting technique, a flashlight is held about one inch from the floor. The beam is then angled so that it just sweeps over the floor surface and is almost parallel to the surface. The light is then fanned back and forth. Any evidence, such as shoeprints, will show up dramatically. Under normal lighting conditions, this evidence may be barely visible or completely invisible.

As the walk through progresses, the investigators should make sure their hands are occupied by either by carrying notebooks, flashlights, pens, etc. or by keeping them in their pockets. This is to prevent depositing of unwanted fingerprints at the scene. As a final note on the walk through, the investigators should examine whatever is over their heads (ceiling, tree branches, etc.). These areas may yield such valuable evidence as blood spatters and bullet holes. Once the walk through is completed, the scene should be documented with videotape, photographs, and/or sketches.

3.3 PROTECTING AND ISOLATING THE CRIME SCENE

The most important aspect of evidence collection and preservation is protecting the crime scene. This is to keep the pertinent evidence uncontaminated until it can be recorded and collected. The successful prosecution of a case can hinge on the state of the physical evidence at the time it is collected. The protection of the scene begins with the arrival of the first police officer at the scene and ends when the scene is released from police custody.

All police departments and sheriff's offices should include intensive training for its personnel on how to properly protect crime scenes. Potentially, any police officer can be put into the position of first responding officer to a crime scene. The first officer on the scene of a crime should approach the scene slowly and methodically. In some cases this is not altogether practical. The first officer may also be involved in arresting an uncooperative suspect or performing life saving measures on an injured victim. In either case the officer should make mental or written notes (as is practical in each situation) about the condition of the scene as it was upon his arrival and after the scene has been stabilized. The officer should keep notes on the significant times involved in responding to the crime scene (time dispatched to scene, time left for scene, time arrived at scene, time left scene, etc.). An

effort must be made to disturb things as little as possible in assessing the situation. Particular attention should be paid to the floor since this is the most common repository for evidence and it poses the greatest potential for contamination. Notes should also be taken if the officer has to alter something in the investigation. Some important aspects that the officer should note include: the condition of the doors, windows, and lighting (both natural and manmade); if there are any odors present; if there are any signs of activity; how emergency service or fire personnel have altered the scene; anything essential about the suspect (description, statements, physical condition, mental condition, intoxication, etc.); and anything essential about the victim. Once the scene has been stabilized, the site and adjacent areas which may yield valuable evidence (driveways, surrounding yards, pathways, etc.) should be roped off to prevent unauthorized people from entering the area and potentially contaminating it. Investigators and other necessary personnel should be contacted and dispatched to the scene; however, under no circumstances should the telephone at the scene be used. Once the officer has secured the scene, he or she could do the following: record witness names and others who may have entered or been at the scene; separate witnesses and suspect(s); do not discuss the events or the crime with witnesses or bystanders or let the witnesses discuss these events; listen attentively but discreetly; and protect evidence which may be in danger of being destroyed. Any actions taken should be reported to the investigators.

Many a times the arrival of additional personnel can cause problems in protecting the scene. Only those people responsible for the immediate investigation of the crime, the securing of the crime scene, and the processing of the crime scene should be present. Non-essential police officers, district attorney investigators, federal agents, politicians, etc. should never be allowed into a secured crime scene unless they can add something (other than contamination) to the crime scene investigation. One way to dissuade unnecessary people from entering the crime scene is to have only one entrance/exit into the crime scene. An officer can be placed here with a notebook to take the names of all of the people entering the crime scene. The officer can then inform them that by entering the crime scene they may pose a problem by adding potential contamination, and the reason that the officer is taking their names is in case the crime scene investigators need to collect fingerprints, shoes, fibers, blood, saliva, pulled head hair, and/or pulled pubic hair from all those entering the crime scene. This will sometimes discourage non-essential personnel from entering the crime scene. The officer can also stop unwanted visitors from entering the restricted areas. If extraneous people do have to enter the scene, then make sure that someone who is working the scene escorts them. This is to make sure that they will not inadvertently destroy any valuable evidence or leave any worthless evidence.

Eating, drinking, or smoking should never be allowed at a crime scene. Not only can this wreck a crime scene but it can also be a health hazard. A command post should be set up for such purposes. The post is to be set up somewhere outside the restricted areas. It could be a vehicle, picnic table, hotel room, tent, etc. It can be used as a gathering place for non-involved personnel, a place for investigators to take breaks, eat, drink, or smoke, a communication center, a place for press conferences, a central intelligence area, etc. The best thing about it is that it is away from the crime scene.

Protection of the crime scene also includes protection of the crime scene investigators. One person, whether a civilian or a police crime scene investigator, should never be left alone while processing the scene. This is especially true if the suspect has not been apprehended. There are many stories of suspects still hiding at or near their area of misdeed. That is why there should always be at least two people working the scene. At least one of them should have a radio and a firearm.

3.4. DOCUMENTATION OF CRIME SCENE BY PHOTOGRAPHY, SKETCHING AND FIELD NOTES

- **Videotape**

If available, a video camera is the first step to documenting a crime scene. Videotape can provide a perspective on the crime scene layout, which cannot be as easily perceived in photographs and sketches. It is a more natural viewing medium to which people can readily relate, especially in demonstrating the structure of the crime scene and how the evidence relates to the crime. The video camera should have a fully charged battery as well as date and time videotape display functions. A title generator and "shake free" operations are also nice options. If a title generator is not available, then about 15 seconds at the beginning of the tape should be left blank. This will allow the addition of a title card with any pertinent information to the beginning of the crime scene tape. The condition of the scene should remain unaltered with the exception of markers placed by the investigators and any lights turned on during the walk through. These alterations can be noted on the audio portion of the tape. Before taping, the camera range should be cleared of all personnel. Any person in the area should be forewarned that taping is about to commence and they should remain silent for the duration of the tape. This prevents recording any potentially embarrassing statements.

Once the video camera begins recording, it should not be stopped until the taping is complete. The key to good videotaping is slow camera movement. A person can never move too fast when videotaping, yet it is all too easy to move the camera fast without realizing it. This is why videotaping is not ideal for viewing detail. People have a tendency to pan past objects in a manner that does not allow the camera to properly capture the object. This is why slow panning of an area is necessary and it should be panned twice in order to prevent unnecessary rewinding of the tape when viewing.

The taping should begin with a general overview of the scene and surrounding area. It should continue throughout the crime scene using wide angle, close up, and even macro (extreme close up) shots to demonstrate the layout of the evidence and its relevance to the crime scene. If videotaping in a residence, the camera can show how the pertinent rooms are laid out in relation to each other and how they can be accessed. This is sometimes lost in photographs and sketches. After the taping is complete, it is wise to leave about 15 seconds of it blank to prevent the crime scene tape from running into anything else previously recorded on the tape. The tape should then be transferred to a high quality master tape. The recording tabs should be removed from the master tape after transferring the crime scene tape and the master should

be stored in a safe place. This is to prevent accidental erasure of the crime scene tape. Copies can then be made from the master tape.

- **Still Photography**

Whether a video camera is available or not, it is absolutely essential that still photographs be taken to document the crime scene. If a video camera is available, then photographs will be the second step in recording the crime scene. If video is not available, then still photography will be the first step. Photographs can demonstrate the same type of things that the videotape does, but photographs from the crime scene can also be used in direct comparison situations. For example, actual size photographs (also known as one-to-one photos) can be used to compare fingerprint and shoeprints photographed at the crime scene to known fingerprints or shoes from a suspect. This is the advantage of photographs over videotape.

Almost any type of camera with interchangeable lenses and a format of 35mm or larger will do in crime scene photography. The lenses should include a 28mm wide-angle lens, a normal 55mm lens, and a lens with macro capabilities (1:4 or better). The flash unit used with the camera should be one that is not fixed to the camera. It should be able to function at various angles and distances from the camera. This is to allow lighting of certain areas to provide maximum contrast, place the flash in hard to reach areas, and reduce flash wash out which can render the item photographed invisible. Print and/or slide color film (25-400 ISO) should be used. A tripod, a level, and a small ruler should also be available for one-to-one photography. It may be of help to the investigation to have a Polaroid camera handy for instant photographs. For example, an instant photograph of a shoeprint found at a crime scene can be provided to investigators who are running a search warrant on a suspect's residence. The photo will tell them the type of shoe for which they are searching.

The photography of the crime scene should begin with wide angle photos of the crime scene and surrounding areas. When shooting the general overall scene, the photos should show the layout of the crime scene and the overall spatial relationships of the various pieces of evidence to each other. A good technique to use indoors is to shoot from all four corners of a room to show its overall arrangement. The next set of photos should be medium range to show the relationships of individual pieces of evidence to other pieces of evidence or structures in the crime scene. Finally, close up photos should be taken of key pieces of evidence. A ruler should be photographed with items where relative size is important or on items, which need to have one-to-one comparison photographs. The object should first be photographed as is, and then photographed with the ruler. It is important that when doing one-to-one photography that the ruler is on the same plane as the object being photographed and the film plane is parallel to the ruler. This is why a level and a tripod are necessary. Notes should also be taken as to what the investigator is photographing or wishes to demonstrate in each photograph. This is to prevent the investigator from getting the picture back at a later date and trying to figure out what he or she was trying to accomplish with the photo. The same areas should be photographed in the same sequence as mentioned above in the paragraphs on videotaping.

- **Crime Scene Sketching**

The final phase in documenting the scene is making a crime scene sketch. The drawback of photographs is that they are two-dimensional representations of three-dimensional objects. As a result, most photographs can distort the spatial relationships of the photographed objects causing items to appear closer together or farther apart than they actually are. If spatial relationships of the evidence are important or if something needs to have proportional measurements included in it for calculations (such as bullet trajectory angles, accident reconstructions, etc.) then a sketch must be made of the crime scene.

A sketch is usually made of the scene as if one is looking straight down (overhead sketch) or straight ahead (elevation sketch) at a crime scene. A rough sketch at the scene is usually made first on graph paper in pencil with so many squares representing so many square feet or inches. Directionality of the overhead view is determined by using a compass. Using a tape measure or other measuring devices, measurements are taken at crime scene of the distances between objects and/or structures at the crime scene. These measurements are proportionally reduced on the rough sketch and the objects are drawn in. Two measurements taken at right angles to each other or from two reference points will usually suffice in placing the objects where they belong in a sketch. Double measurements should also be taken to make sure they are correct. This is especially true where calculations will later be used. A final sketch can be made later using inks, paper, and ruler, or a computer. The original rough sketch should be retained and preserved in case it is needed at a later date. Once the scene has been thoroughly documented then the evidence collection can commence.

Taking Notes at the Crime Scene

- Field notes are brief notation concerning specific events, which the officer encounters in performance of his duties.
- Field notes provide basis for representation:
- The officer's field notes provide a skeletal frame of significant factors related to an event, which can be used into a complete representation.
- Field notes provide greater accuracy in documenting time, events & statements than the officer's memory.

Information to be noted carefully:

Who ??

- Committed the crime?
- Was the victim?
- Saw what happened?

What ??

- Was the relation between victim & suspect?
- Crime was committed?
- Evidence might be there?

Where ??

- Did crime occur?
- Was evidence located?

- Was entry & exit made from?

when ??

- Was crime committed & reported?
- Was the scene released?
- Did first responder arrive?

Why ??

- Was crime committed?
- Was the victim chosen?
- Was the location chosen?

How ??

- Did the perpetrator gain entry?
- Was crime committed?
- Did the perpetrator depart?

Field notes should contain the following:

- Identification of the date & time of arrival on the crime scene.
- Description of the scene on arrival, including weather, lighting, geographical location, etc.
- Description of scene e.g. disarranged furniture, forced entry, blood stains, blood splatter, etc.
- List of absent items, which often reveal about the perpetrator & the nature of crime.
- The type & location of the wounds should be recorded.
- Photograph log & videotape log.

Uses of Field Notes

- Retrieval of statements given by the suspects, witnesses & victims.
- These notes assist in impeaching the new statement & may lead to confusion.
- It is through gathering, correlating, organizing & comparing info that the crime scene is reconstructed & derivative evidence develops.
- Notes are important in preparing for interviews of witness, interrogation of suspects & testifying before the court.

CHECK YOUR PROGRESS

1. What all measures are required to be taken for protecting the scene of crime?
2. Explain briefly the role of photography in documentation of Crime Scene.
3. What all information needs to be captured while taking notes during the crime scene investigation?

3.5. SUMMARY

In this unit we have studied about what is a crime scene, How to isolate and protect the scene of crime. We have also mentioned about different methods of documenting a crime scene. The role played by the photography, sketching and field notes in the documentation of the crime is also highlighted in this unit. As the goal of crime-scene documentation is to create a visual record that will allow the forensics lab and the prosecuting attorney to easily recreate an accurate view of the scene.

UNIT-4 : TYPES, SIGNIFICANCE AND CLASSIFICATION OF PHYSICAL AND TRACE EVIDENCES

Structure

- 4.0 Introduction
- 4.1 Objectives
- 4.2 Types and Significance of Physical and Trace Evidence
- 4.3 Classification of physical evidence
- 4.4 Collection, Care and Submission of Evidence
- 4.5 Chain of evidence
- 4.6 Reconstruction of Crime Scene
- 4.7 Significance of density, conductivity, refractive index and particle size in analyzing the trace evidence
- 4.8 Evidence pertaining to toolmarks, glass, fibre and soil
 - 4.8.1. Evidence pertaining to Tool marks
 - 4.8.2 Evidence pertaining to Glass
 - 4.8.3. Evidence pertaining to Fiber
 - 4.8.4. Evidence pertaining to Soil
- 4.9 Summary

4.0 INTRODUCTION

Forensic scientists often work as generalists, meaning that they have expertise in working with a wide variety of evidence types. However, many also specialize in the use of certain techniques and tools. Different types of evidence require different skills and equipment. Types of evidence that are most frequently analyzed during investigations include: trace evidence and physical evidence. Trace evidence is found wherever an object or person has had contact with another object or person and each of the objects leaves behind some sign of its having been there. Fingerprints and tire tracks are examples of trace evidence. Physical evidence will be found wherever there is a human or animal remains present, and can include DNA testing.

4.1 OBJECTIVES

- Classify various types of Physical evidences
- Collect Physical evidences
- Define Chain of Evidence
- Submit the evidence with care
- Reconstruct the scene of crime
- Define Trace evidences
- Define the importance of density, conductivity and refractive index in analysis of trace evidences
- Define evidences pertaining to the tool marks, glass, fiber and soil

4.2 TYPES AND SIGNIFICANCE OF PHYSICAL AND TRACE EVIDENCES

Evidence can be defined as information given in a legal investigation that makes a fact or proposition more or less likely. Whether in the form of personal testimony, the language of documents, or the production of material objects, evidence is critical to a trial. It provides the foundation for the arguments the attorneys plan to offer. It is viewed as the impartial, objective, and sometimes stubborn information that leads a judge or jury to their conclusions.

The trace evidence section of the Forensic Science Laboratory deals with the analysis of both microscopic and macroscopic traces of physical evidence. These may include but are not limited to hairs, fibers, paint, soil, polymers, glass, and impressions. These types of evidence are frequently found at crime scenes such as homicides, rapes, assaults, burglaries and automobile accidents.

During the commission of a crime a suspect may often come into contact with the victim, the environment of the crime scene, or both. During this interaction, exchanges of physical evidence may occur. For example a suspect may leave behind a shoeprint at a crime scene or may take away fibers shed from an item of clothing worn by the victim. The trace evidence laboratory specializes in the examination of this type of evidence with the goal of linking suspects to victims and/or crime scenes. The Trace Evidence section currently employs three full time analysts for the examination of this type of evidence.

- **Microscopic Trace Evidence**

A majority of evidence examined by the trace evidence section is microscopic in nature. Thus this section relies heavily on the use of various types of microscopes to examine physical evidence. An initial examination to detect this microscopic evidence is conducted using a stereomicroscope. The trace evidence examiner may sort through debris removed from an article of evidence or may examine the article directly.

Once the material is sorted and removed, analysis proceeds using a variety of other microscopic techniques. Synthetic fibers are initially identified using the polarized light microscope. Examinations and comparisons can be conducted using the laboratory comparison microscope. More sophisticated chemical analysis on fibers and paints can be conducted using the micro-Fourier Transform Infrared Spectrometer. If the fibers or paints are colored these can be spectroscopically compared by the Visible Micro spectrophotometer. For evidence beyond the capabilities of a normal microscope, the trace evidence section can utilize a state of the art digital Scanning Electron Microscope.

A Pyrolysis Gas Chromatograph-Mass Spectrometer can be used to identify polymers. Solid materials such as paints, fibers and plastics are heated, broken down and volatilized. Based upon the molecular fragments observed, the material can be identified.

- **Impression Trace Evidence**

In addition to microscopic evidence, the trace evidence section also deals with physical evidence such as tire and shoeprint impressions. These can be found in several different types of materials, such as paint, blood, soil and dust. Information can be derived from casts or lifts of these impressions and determinations can be made as to manufacturer and/or type of object

that produced them. Other examples of impressions examined by the section may include those produced by fabrics. These can be found in a wide variety of cases. They may occur imbedded in the paint of a car involved in a hit and run case or transferred from an article of bloody clothing at a crime scene. These can be photographically documented, enhanced and subsequently linked back to clothing worn by the victim.

The impression section utilizes both macro and micro casting techniques for comparisons of shoeprints, tyre prints and other impressions. In addition to casting techniques, impressions can be lifted from a variety of surfaces. Techniques include gel lifts or utilization of the laboratory's electrostatic lifting device. These lifts can then be compared to impressions of known footwear prepared in the laboratory.

- **Gunshot Residue on Clothing and Other Items**

Trace evidence examiners use microscopy to identify propellant residue particles deposited on clothing and on other items. This residue is produced when a gun is discharged, and mainly consists of burned and partially burned gunpowder, vaporous lead and other materials. Non-visible residue can be developed using various wet chemical techniques such as the Modified Griess Test and the Sodium Rhodizinate Test. Investigators to determine the approximate distance between the victim and the shooter can use this information, as well as the type of pattern observed.

- **Hit and run examinations**

The trace evidence examiner is routinely called upon to link hit and run vehicles to crime scenes. This can be accomplished through physical matches involving scene debris such as broken headlights and comparison to areas of corresponding damage on a suspected vehicle. Microscopic paint samples left on a victim's clothing or in the roadway can be searched against an automobile paint library containing several hundred known specimens. The lab also makes use of the Paint Data Query (PDQ), which is a database of chemical identities of various layers of paint on vehicles. These types of searches can provide investigators with a description of a possible hit and run vehicle even when no eyewitnesses exist. If a suspect vehicle is identified, a paint sample can then be obtained and compared both chemically and microscopically to the sample found at the crime scene.

4.3. CLASSIFICATION OF PHYSICAL EVIDENCE

A combination of the importance and value of physical evidence in both criminal and civil investigations and the continuing advance of the applications of science and technology has caused

the role of physical evidence to grow to unprecedented levels. Various types of physical evidence may include:

1) **Transient Evidence**

Odor, temperature, imprints and markings

2) **Pattern Evidence**

Blood spatter, glass fracture, fire burn, furniture position, projectile trajectory, track-trail, tire or skid mark, modus operandi, clothing or article, powder residue, material damage, body position, shoe or boot print.

3) **Conditional Evidence [Event/Action Correlated]**

- Lighting conditions (vehicle headlights, indoor)
- Smoke (color, odor, density)
- Fire (color of flames, speed & direction, temperature, condition)
- Location (weapon, bloodstains, vehicle, broken glass, wounds)
- Vehicle (locked, windows open, radio on, radio station, ignition key, odometer)
- Body (rigor, lividity, decomposition, temperature, position, wounds)

4) **Transfer Evidence [Physical Contact]**

Classification by material Composition and Structure

A. **Physical Form**

Solid, Liquid or Vapor

Crystalline or Non-crystalline / Vitreous / Glassy

B. **Chemical Composition**

Organic compounds:

Blood, skin, hair, semen, saliva, wood, paper, plastics, dust etc.

Inorganic elements & compounds:

Metal, glass, minerals, plastics, paint, soil, bone, fibers

Composites:

Construction materials: building / aerospace

C. **Data, Patterns & Images (Recorded and/or Printed):**

Fingerprints, tool marks, tire tracks, printed documents, Voiceprints, videotapes, and digital data, computer files

4.4. COLLECTION, CARE AND SUBMISSION OF EVIDENCE

Criteria for acceptance of samples for forensic examination at forensic science laboratories

Conviction rate versus Forensic Science

When an item of evidence that could be crucial to securing a conviction appears in court, judge and jury want to be sure that it really is relevant to the crime. The only way of fulfilling this requirement is to make the concept of quality central to everything the forensic investigator does with the evidence, from collecting it to presenting it in court. Perhaps the most important requirement here is an awareness of the importance of the **chain of custody** of evidence.

Investigation for and Collection of Physical Evidence

- Most scenes have physical evidence and much is collected to ensure it does not perish and to comply with modern forensic science expectations
- Much physical evidence is filtered between crime scene and laboratory analysis -most by crime scene technicians and investigators
- Most of the court proceedings depend mainly on laboratory examination results.

Collection of physical evidences

- By hospital authority
- By crime scene team
- By trained Investigators
- By untrained staff

Variety of physical evidences

1. Body samples
2. Fibers, hairs
3. Marks
4. Glass
5. Paint
6. Arson investigation
7. Explosives
8. Weapons
9. Drugs
10. Toxicology
11. Vehicles
12. Digital hardware/SW
13. Counterfeit currency

Collection of biological samples for sexual offences

- **Liquid blood**- Preferably 4ml.in plastic sterile EDTA screw cap type container. If partially clotted, to be lifted with sterile blade. To be kept frozen until arrival at the CFSL/FSL.
- **Wet blood stain**- To be dried naturally. Each item to be placed in properly sealed paper envelop/cardboard box/polythene bag
- **Dry blood stain**- To cut the surface bearing the stain leaving an unstained area of 2-3 cm around the stain. Scrapping of dry blood on to a sheet of paper in case not possible to cut.
- **Small dried blood spot**- Moistened cotton swab concentrating as much stain as possible and to keep in a tube, sealed and kept in cooled place.
- **Blood clot** in clothing and bedding, to be submitted individually packaged in paper bags /sacks, to be stored in cooled and dry place. A control sample should always accompany.
- **Semen stains**- to be dried naturally. Each item to be placed in properly sealed paper envelop/ polythene bag and kept in cool dry environment.
- **Vaginal/anal/oral swab**- To maximize recovery of semen, multiple sterile swabs should be taken from each area, labeled and marked exact location of sampling. To be kept in swab sleeve/ tube, sealed and frozen.
- **Penile swabs**- To be collected with moistened sterile water and kept in swab sleeve/tube, sealed and frozen.
- **Liquid semen**- To be collected in a sterile container, kept in swab sleeve/tube, sealed and frozen.
- **Saliva**- Collection of buccal scrapes or swabs from around the teeth and gums. To be kept into sterile wide mouthed universal bottle with screw cap. Do not use glass. To be labeled with donor's name, date and time. To be frozen immediately.
- **Saliva stains**- Whole item to be submitted after drying naturally in sealed package. Moistened swabs if to be collected from body. To be kept in paper pack/swab sleeve and frozen.
- **Cigarette butt**- Completely dried ends to be stored separately packaged polythene bag, cooled and kept in dry environment.
- **Drinking vessel**- In upright position with liquid in the vessel, sealed, kept in cool dry environment.
- **Hairs**-To be wrapped in a paper, sealed in polythene bag / screw cap vial. Stored in cool environment.
- **Tissue sample**- Should be in frozen condition, sealed in sterile plastic container.
- **Bones/teeth**- At least two teeth, in a sterile plastic container.
- **Fingernail debris**- Clippings in sterile plastic container, in cool dry environment.
- **Aborted foetus**- Frozen state in a suitable, rigid, plastic container.

NOTE : Wherever possible, control sample to be sent along with samples.

Collection of fibers/hair

Submit the whole item where fibers may have been transferred. Where items cannot be transferred to FSL, tapings can be done with 1" wide adhesive tape, to be placed in polythene bag. For combings, combs should be fine-toothed. Comb should be paper packaged, sealed in an envelope, to be stored in cool dry environment.

Ropes/twines- to be submitted the whole length. To be wrapped separately and sealed effectively.

Head hair- Minimum 25 hairs, to be pulled by its root from different parts of the head, to be wrapped in a paper packet, sealed in polythene bag, stored in a cool, dry environment.

Marks

Footwear: Whole item to be submitted, packaged separately in a box/folder, secured and sealed effectively. Marked surface to be protected.

3-dimensional for tyre/footwear – To be photographed with scales, in situ. To be submitted with negatives.

Tool marks- Wherever possible, the whole item bearing the mark to be submitted. Packaged in any appropriate sized container, taking care to protect the damaged area and to prevent leakage of particulate material.

Cut items : All cut ends to be submitted. While submitting locks/padlocks, submit keys. To be packaged in a suitable container.

Fabric and glove – Submit whole item, in appropriate container, such as a box and sealed effectively.

Glass

At least 6 pieces of glass from around the each broken glass pane area to be collected and packaged separately in polythene bags, further in sturdy cardboard box and sealed. The recovered glass should represent the full original thickness & should be representative of all glass types present. Avoid recovering glass from floor. Glass pieces to be marked with permanent marker. Control sample to be submitted positively. In case of footwear mark in a glass pane along with bloodstain, the latter can be swabbed/ scrapped, no attempt to be made to lift the footwear mark.

Paint

- Preferably the object should be submitted wholly.
- In case it is not possible, adequate sample to be removed from all areas where instrument mark is there, careful scrapping is to be taken without disturbing the mark.
- Scrapping to be put in an envelope or polythene bag, sealed and stored in a cool, dry environment.
- A control sample must be accompanied and that should be collected from as close as possible to all damaged area.

Arson investigation

- Petroleum product- Submit the sample in clean metal/glass container with a well-fitting screw cap.
- The container should be sealed in a nylon bag and placed in a rigid container.
- The items bearing the stains of petroleum products to be sealed in an airtight polythene bag.

- Hand swabs- Clean, dry cotton wool to be used and submitted along with control.
- Other fire related items- Handle as little as possible and to be packed in a sturdy box or tin and secured.

Weapons

- Weapon should be unloaded.
- The position of any cartridges in the chambers of revolvers/shotguns should be noted. Any cartridges removed from the chamber should be packed separately.
- While packaging, the muzzle ends of sawn-off barrels should be protected by a small bag, placed over the muzzle and taped in place on the barrel about 5cm back from the muzzle. Do not tape over the end of the barrel at any time.
- Firearms should be stored in dry conditions to prevent rusting, which can rapidly develop in fired gun barrels.

Drugs

- Tablets, capsules, powder can be packed in either paper packet or in polythene bags
- Cannabis plants parts should be placed in brown paper envelop inside a perforated tamper proof bag.
- Hypodermic syringes & needles- to be submitted in intact condition in proper secured box.

Counterfeit currency

- Should be properly sealed and labeled.
- In case of any liquid submission, it should be in properly secured inert container.

Questioned Documents: Questioned Material to be submitted

All questioned documents involved in a particular investigation should be submitted to the Laboratory for examination. This is important since questioned documents are identified by a comparison of similarities, plus an absence of divergences or dissimilarities. In order to make identification, sufficient handwriting, typewriting, or other evidence must be available on which to base an opinion. This means that all questioned material is needed, as well as sufficient exemplars or known specimens.

Exemplars

It is very important to have sufficient handwriting exemplars for comparison with the questioned document. One or two signatures on a suspect's driver's license or a draft card, in many cases, does not contain sufficient individual characteristics on which to base a conclusion. In some instances, such an examination may substantiate a suspicion and this should be considered as an investigational lead. To support this, it is necessary to obtain and examine additional standards.

Collected specimens that were made in business transactions such as receipts, promissory notes, credit and employment applications, letters, booking card, and fingerprint card signatures are writings that, in most cases represent the individual's most normal writing. It is significant in many cases that these writings be of the same date as the questioned document. It is important to obtain request specimens from a suspect at the first interview; the suspect may be uncooperative at a later date.

The conditions surrounding the preparation of the questioned document should be duplicated as nearly as possible when the request exemplars are obtained. If yellow-lined paper and blue ink were used to produce the questioned document, the same or similar color and type of paper and instrument should be used. If the suspect document is a threatening letter and the note is either handwritten or block lettered, the same style should be requested from the writer. Have subjects write their names and addresses several times and brief personal histories. This should be removed and another sheet of paper furnished. Dictate the exact words and numbers, which appear on the questioned document. This should be done at least 12 times, removing the specimens from the writer's view as they are produced. If it is a check case, the specimens should be taken on blank checks or slips of paper of the same/appropriate size. The number of specimens necessary for identification in any specific case cannot be determined; therefore, at least twelve specimens should be obtained for each questioned document.

When securing typewritten exemplars, several copies of the questioned documents should be made on the suspected machine using light, medium, and heavy touches. At least one copy should be made with the ribbon removed from the machine, or the ribbons set on stencil, and the keys allowed to strike directly on a sheet of new carbon paper, which should be inserted on top of the paper used for the specimen. This provides clear-cut exemplars of any machine's typeface, showing disfigurements in type characters. Always type the exemplars on the same type and color of paper as that used on the questioned document.

Preservation of Questioned Documents

- Under no circumstances should either the questioned document or the exemplars be marked, defaced, or altered. No new folds should be made, nor should marks or notes be placed on such material. Personal marks for identification purposes should be made as small as possible on the back or other area of the document where no handwriting or typewriting is present.
- Whenever possible, all documents should be protected by placing them in cellophane or plastic envelopes.

Shipment of Evidence

- Questioned documents may be submitted personally or left in previously described lockers at the Laboratory entrance.
- Such evidence sent to the Laboratory by mail must be sent by certified or registered mail. If there is a massive amount of material, it may be sent some other way, but the package must always be sealed.

Charred Documents

Where examination and decipherment of charred paper is involved, great care must be taken to prevent any additional crumbling or breaking apart of the burned material. Normally it should be placed on top of loose cotton in a box and delivered in person to the Laboratory. No matter how it is packaged, such material will be damaged if attempts are made to ship it by mail.

Other Questioned Document Evidence

In addition to handwriting and typewriting comparisons and the decipherment of charred documents, many others related the Laboratory could conduct examinations. These include, but are not limited, to:

- Restoration or decipherment of altered, obliterated, or erased writing.
- Comparison of check protectors and rubber stamps with questioned printing.
- Identification of embossed or indented writing or typing.
- Comparison of paper and commercially printed material, such as checks, coupons, receipts, and others.
- Physical matching of cut or torn paper of various types.
- Problems relating to ink.

Latent Fingerprints

Marking of Latent Fingerprint Evidence

- All such evidence should be marked in some distinctive manner, such as is the case with any other type of physical evidence. Precautions should be taken, when marking evidence, not to damage or destroy potential latent fingerprints.
- Lifted, developed latents should also be marked or sealed in marked envelopes.
- Photograph-developed latents with and without identifying markings and scale.

4.5. CHAIN OF EVIDENCE

Chain of Evidence/custody (CoC) refers to the chronological documentation or paper trail, showing the seizure, custody, control, transfer, analysis, and disposition of evidence, physical or electronic. Because evidence can be used in court to convict persons of crimes, it must be handled in a scrupulously careful manner to avoid later allegations of tampering or misconduct which can compromise the case of the prosecution towards acquittal or to overturning a guilty verdict upon appeal. The idea behind recording the chain of custody is to establish that the alleged evidence is in fact related to the alleged crime, rather than having, for example, been planted fraudulently to make someone appear guilty.

Establishing chain of custody is made of both a chronological and logical procedure, especially important when the evidence consists of fungible goods. In practice, this most often applies to illegal drugs, which have been seized by law enforcement personnel. In such cases, the defendant at times disclaims any knowledge of possession of the controlled substance in question. Accordingly, the chain of custody documentation and testimony is presented by the prosecution to establish that the substance in evidence was in fact in the possession of the defendant.

An identifiable person must always have the physical custody of a piece of evidence. In practice, this means that a police officer or detective will take charge of a piece of evidence, document its collection, and hand it over to an evidence clerk for storage in a secure place. These transactions, and every succeeding transaction between the collection of the evidence and its appearance in court, should be completely documented chronologically in order to withstand legal challenges to the authenticity of the evidence. Documentation should include the conditions under which the evidence is gathered, the identity of all evidence handlers, duration of evidence custody, security conditions while handling or storing the evidence, and the manner in which evidence is transferred to subsequent custodians each time such a transfer occurs (along with the signatures of persons involved at each step).

4.6. RECONSTRUCTION OF CRIME SCENE

The process of working out the sequence of events before, during, and after a crime is known as crime scene reconstruction. It is perhaps one of the aspects of forensic science that fascinates the public most, featuring in most police dramas. Reconstruction requires not just a scientific approach but also logic, experience, and open-mindedness on the part of the investigating team who must be prepared to set aside any hypothesis that does not fit with the actual evidence presented to them.

Reconstruction starts when the investigator takes a first walk through the scene where the crime took place. Even at this stage, it may be possible to construct a rough hypothesis of what may have happened and how. A hypothesis is a set of ideas or a general picture of what may have happened. It does not become a theory until it fits all the available evidence and supporting information.

While the investigator is forming a first impression, others are recording the scene and gathering evidence. Crime scenes vary enormously, from a petty theft or break-in to violent crime that may involve fire or explosions. The principles of investigation remain the same, although the investment of time and energy into it will vary with the seriousness of the crime. The investigator will want to establish who was involved—that is, what are the identities of the victim, perpetrator, and witnesses. They also need to know where, when, how, and why the crime took place.

The crime scene is first documented through notes-taking, video, photography, and sketching. The investigating team will then search for record, collect and take away various kinds of evidence such as tool marks, hair, bloodstains, fibers, and footprints. According to Locard's exchange principle, every contact leaves a trace. That is, those involved in the crime always leave something behind or take something with them. Think of putting your hand on a patch of wet paint. The handprint may be

clearly visible. You will also have paint stains on your hand. Evidence of this kind in a crime situation is known as trace evidence and consists of tiny amounts of substances like fibers, paint, mud, soil, or blood. Often it is only visible through a microscope and needs specialist laboratory investigation to assess its significance to the investigation.

To render trace and other types of evidence valid and admissible to the court, it is essential to have strict control of how the site is investigated to avoid undue interference or contamination. That is why access to the crime scene has to be limited and those involved will always proceed from the police cordon to the site of the crime itself down a common approach path, which will be set so as to allow minimal interference with any evidence.

Everyone who handles a piece of evidence is recorded and hands it on to the next in line so that a tight chain of custody—from the scene to the laboratory and, eventually, the courtroom—is created. There are special ways of transporting evidence to protect it. Dry trace evidence, such as hairs and fibers, might be placed in druggists' folds, which are small, folded papers. Wet evidence, including bloody clothing, has to be allowed to air dry because moisture can attract molds that might decay the specimen, rendering it useless. After being placed inside an appropriate primary container, pieces of evidence are then placed inside a larger container, completely sealed with tamper-proof tape and carefully labeled. Each item is packed separately to prevent cross-contamination, which could otherwise destroy the credibility of the evidence. In the case of tool marks on points of entry, it may even be necessary to remove a whole door or window rather than attempt to excise the mark, which may damage it. Once in the forensic laboratory all the pieces of evidence are then analyzed and interpreted.

Bloodstain patterns are a vital aid to the reconstruction of a violent crime. When blood drips from wounds, weapons, or other objects, a splash or spatter pattern is created. The shape of the splash can show whether the source of the blood was moving and, if so, in which direction. Should the victim or perpetrator attempt to run away, the trail of blood will tell the investigator more details about the escape attempt because the shape of the blood drops will help reveal it. When someone is shot or hit with a blunt object, blood is projected from the wound and hits surrounding surfaces and objects. The resulting pattern can be analyzed to show how the weapon impacted the victim. There may be a break in the pattern; no blood where it would be expected on, for instance, a wall. This may suggest where the attacker was standing and whether the victim was struck or shot from the front or behind.

Blood is messy. During an attack it is also transferred to clothes, shoes, and hands and may leave behind bloody prints. Blood-soaked fabric makes marks with a characteristic weave pattern upon objects it comes into contact with, like a getaway car.

Some forensic tools are particularly important in crime scene reconstruction. Fluorescent chemicals glow when they are exposed to ultraviolet light. An important example is luminol, a chemical that reacts with hemoglobin, the red pigment in blood. Luminol detects blood at a concentration as low as one part in five to ten million or even lower. It is extremely valuable in revealing blood that the perpetrator believes he or she has cleaned away, such as bloodstains in a car used to remove the victim's body. However, luminol cannot detect bloodstains that have been wiped away with bleach.

In such cases, fluorescein can be used as an alternative. In other words, fluorescent chemicals and light can be used to detect invisible trace evidence, giving a truer picture of the crime scene.

Footprints are a particularly rich source of evidence in a reconstruction because they can link a suspect to the crime scene. Even if the suspects say they were not there, their footprints, if matched, can tell a different story. Footprints have proved to be especially important in cases of homicide, assault, robbery, or rape. When someone is at the scene of the crime, their soles come into contact with surfaces and leave an imprint, visible or not, which can be detected, examined, and assessed. Some prints, such as those made in the blood of a victim, are particularly obvious. If the print is in contact with a soft surface such as sand, soil, or snow, it will leave a three dimensional impression. Should the contact be with a hard surface, the print is two-dimensional. Either the surface itself is removed and taken to the laboratory, or specialized photographs are made. The footprint can be linked to a particular kind of shoe by comparison with a footwear database. Individuals also wear down their shoes in a certain way, depending upon their gait. Other features such as scuffmarks can also be identified within the prints. Unless a suspect has had the foresight to destroy their footwear, examination of their shoes and comparison with footprints found at the scene can link them with the crime.

The investigators often carry out their own experiments to test the hypothesis. For instance, in establishing the relative location of victim and perpetrator in a shooting incident, it is important to know the distance between the gun and the point of impact. Was the victim shot from the front or from behind? Was the suspect shooting at point blank range or from a distance? Simulation experiments to solve this question would involve shooting from an identical weapon from different distances at a laboratory target. The resulting damage from the bullet could then be compared to that found at the actual scene of crime.

The investigators must then relate all the evidence they have collected and analyzed with other information, such as autopsy reports and witness statements, continually refining or even rejecting their original hypothesis. The autopsy may show, for example, the time of death and whether the body has been moved. A witness statement may not be consistent with the evidence, which may provide a basis for further interrogation with questions directed by the interpretation of the evidence. This process will generate new information to be fitted into the hypothesis.



New information may continue to come in and must be examined to see if it is consistent with the hypothesis. A murder weapon or even a body may be found during the investigation. Maybe a witness will change or add to their statement. The final reconstruction is the investigator's presentation of the sequence of events before, during, and after the crime. It gives the location and position of everyone involved. More important, it tells how and why the crime occurred. The investigators can expect to be challenged in court, of course. While investigators can never be sure of what actually happened at the scene of the crime, yet if they have used scientific principles and their experience in the reconstruction they can play a valuable role in explaining the crime and seeing that justice is done.

4.7. SIGNIFICANCE OF DENSITY, CONDUCTIVITY, REFRACTIVE INDEX AND PARTICLE SIZE IN ANALYZING THE TRACE EVIDENCE

Trace evidence

It is the physical evidence found at crime scene, like glass, soil, fiber hair etc. Locard's exchange principle very well applies to the transference of trace evidence.

Significance of Density

- Is physical property of matter
- Varies with temperature
- Use to solve forensic cases

Glass density determination

1. Density gradient column method

- Set gradient tubes

- Heavy liquid is mixed with lighter liquid to form density gradient
- Bottom layer of heavy liquid
- Middle layer of equal mixture
- Last layer of light liquid
- Each layer is added very slowly
- Fragments placed in density gradient and allow to settle

2. Density determination

- Weigh the piece of glass using triple beam balance
- Place 50ml of water in beaker
- Place the glass piece in beaker
- Measure the new volume
- Subtract 50ml from new volume
- Density=Mass/Volume
- Soil density determination
- In forensic analysis, we use dry soil
- If we get wet soil firstly we dry it
- Using density gradient column method
- Density =mass/volume
- For volume introduce dried soil in beaker containing pure water
- Measure increase in volume=volume of dried soil

Significance of Refractive index

- Is speed of light in vacuum/speed of light in medium
- Varies with temperature
- Remains same for long time

Measure refractive index

By immersion method

- Place glass in beaker
- Add lower index(N_1) liquid volume(V_1) to cover glass
- Add liquid of higher index(N_2) volume(V_2)
- Until glass become invisible
- $RI = [N_1 V_1 + N_2 V_2] / V_1 V_2$

Soil conductivity

- Conductivity depend on concentration of ion/salt
- Using Conductivity meter
- Collect soil, dry it
- Use sieve

- Put ½ cup dried soil in beaker
- Put ½ cup distilled water in soil beaker
- Stir gently
- After 30 min stir again
- Insert EC meter
- Record display reading

4.8. EVIDENCE PERTAINING TO TOOL MARKS, GLASS, FIBRE AND SOIL

4.8.1. Evidence pertaining to Tool marks

Tool marks examination and comparison represents the core area of study for firearm and tool mark examiners. The conceptual and practical aspects of tool mark identification provide the skills necessary for **firearms identification**; in fact, firearm identification is a specialized subset of tool mark identification. There are potentially many more variables in terms of the marks to be examined. As a forensic discipline, microscopic comparison and potential identification of striated or impressed tool marks as having been made by the same tool are central to the identification of tool marks.

The foundation for this technique is based on the following concepts:

- A tool is defined as the harder of two objects which, when brought into contact with each other, results in the softer object receiving a tool mark.
- Tools (e.g., screwdrivers, firearms, bolt cutters, etc.) will bear unique microscopic characteristics due to the manufacturing processes they undergo, as well as their use and abuse.
- These characteristics will mark surfaces (e.g., locks, cut wires, fired bullets, etc.) with class and individual characteristics.
- These class and **individual characteristics** are reproducible and identifiable with a particular tool.

Tool mark Identification is a forensic science discipline that has as its primary concern the determination of whether or not a toolmark was produced by a particular tool. This determination is based on the class and individual marks in a given tool, which, in turn, are products of the manufacturing process.

The main difference between firearms and toolmark identification is that the relative orientations of the harder object and the softer object in firearms examination are easily predictable; while in the typical toolmark matter this is often not the case.



4.8.2 Evidence pertaining to Glass

Glass is defined as an “inorganic production of fusion that has been cooled to a rigid condition without crystallization”. This material is composed of a mixture of inorganic materials that are responsible of its different physical properties.

Glass is a mixture of inorganic components present at different concentration levels (major, minor and trace levels ranging from %w/w to ppb levels).

Some of these components are added intentionally to assure durability, to decrease the cost of manufacture or to provide desired properties such as color, heat resistance and safety. Some other components are present unintentionally at trace levels in the final product as contaminants from the raw materials or the manufacturing process.

Glass can be classified in different groups according to their **intended use** as:

- a) Flat glass (for architecture and automobiles)
- b) Containers (bottles, glasses and jars)
- c) Glass fibers (for insulation) and
- d) Specialty glass.

They can also be classified by their **main raw materials** as

- a) Soda lime (containers and windows)
- b) Leaded glass (housewares and decorations)
- c) Borosilicate glass (industry, lamps and cookware)
- d) Special (optical, electronics)

The main raw materials utilized for the manufacture of soda lime glasses are sand (SiO_2), soda ash (Na_2CO_3) and limestone (CaO). Borosilicate glass contains boron to provide heat resistance, and “leaded” glasses, as its name implies, incorporate lead as an additional raw material to enhance the refractive index.

Sand, the major source of silica, requires certain characteristics in order to be employed in the manufacturing of glass. Small impurities present in the sand could produce undesired properties in the final product such as color, alter furnace temperatures or produce non-glassy impurities.

The components of glass are classified according to their function as: formers, fluxes, modifiers, stabilizers, colorants, decolourants, refining and opaliser agents.

- **Formeragents** are products that generally form the framework of the glass structure.
- **Fluxes** are components that are added to the formers to lower the melting temperature and to reduce cost of production.
- **Stabilizers** are added to offer chemical resistance to the glass, while decolourants are used to clarify the glass.
- **Refining** agents are also an important component of glass that helps to remove bubbles from the molten glass during its production.

4.8.3. Evidence pertaining to Fiber

A fiber is the smallest unit of a textile material that has a length many times greater than its diameter. Fibers can occur naturally as plant and animal fibers, but they can also be man-made. A fiber can be spun with other fibers to form a yarn that can be woven or knitted to form a fabric. The type and length of fiber used, the type of spinning method, and the type of fabric construction all affect the transfer of fibers and the significance of fiber association at crime scenes. This becomes very important when there is a possibility of fiber transfer between a suspect and a victim during the commission of a crime.

As discussed previously, fibers are considered a form of trace evidence that can be transferred from the clothing of a suspect to the clothing of a victim during the commission of a crime. Fibers can also transfer from a fabric source such as a carpet, bed, or furniture at a crime scene. These transfers can either be direct (primary) or indirect (secondary). A primary transfer occurs when a fiber is transferred from a fabric directly onto a victim's clothing, whereas a secondary transfer occurs when already transferred fibers on the clothing of a suspect transfer to the clothing of a victim. An understanding of the mechanics of primary and secondary transfer is important when reconstructing the events of a crime.

When two people come in contact or when contact occurs with an item from the crime scene, the possibility exists that a fiber transfer will take place. This does not mean that a fiber transfer will always take place. Certain types of fabric do not shed well (donor garments), and some fabrics do not hold fibers well (recipient garments). The construction and composition of the fabric, the duration and force of contact, and the condition of the garment with regard to damage are important considerations.

An important consideration is the length of time between the actual physical contact and the collection of clothing items from the suspect or victim. If the victim is immobile, very little fiber loss will take place, whereas the suspect's clothing will lose transferred fibers quickly. The likelihood of finding transferred fibers on the clothing of the suspect a day after the alleged contact may be remote, depending on the subsequent use or handling of that clothing.

Natural Fibers

Many different natural fibers originating from plants and animals are used in the production of fabric. Cotton fibers are the plant fibers that are most commonly used in textile materials. The variety of cotton, fiber length, and degree of twist contribute to the diversity of these fibers. Processing techniques and color applications also influence the value of cotton fiber identifications.



Cotton fibers

Other plant fibers used in the production of textile materials include flax (linen), ramie, sisal, jute, hemp, kapok, and coir. The identification of less common plant fibers at a crime scene or on the clothing of a suspect or victim would have increased significance.



Wool fibers

The animal fiber most frequently used in the production of textile materials is wool, and the most common wool fibers originate from sheep. The end use of sheep's wool often dictates the fineness or coarseness of woolen fibers: Finer woolen fibers are used in the production of clothing, whereas coarser fibers are found in carpet. Fiber diameter and degree of scale protrusion of the fibers are other important characteristics. Although sheep's wool is most common, woolen fibers from other animals may also be found. These include camel, alpaca, cashmere, mohair, and others. The identification of less common animal fibers at a crime scene or on the clothing of a suspect or victim would have increased significance.

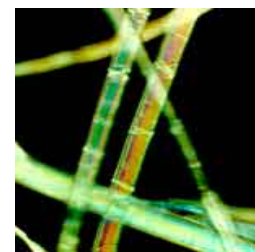

Flax fibers viewed with polarized light

Man-Made Fibers

More than half of all fibers used in the production of textile materials are man-made. Some man-made fibers originate from natural materials such as cotton or wood; others originate from synthetic materials. Polyester and nylon fibers are the most commonly encountered man-made fibers, followed by acrylics, rayons, and acetates. There are also many other less common man-made fibers. The amount of production of a particular man-made fiber and its end use influence the degree of rarity of a given fiber.

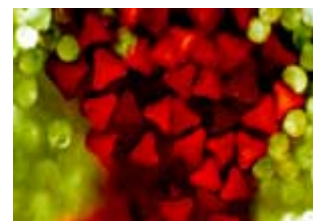

Cross section of man-made fibers

The shape of a man-made fiber can determine the value placed on that fiber. The cross section of a man-made fiber can be manufacturer-specific: Some cross sections are more common than others, and some shapes may only be produced for a short period of time. Unusual cross sections encountered through examination can add increased



significance to a fiber association.

Fiber Color

Color influences the value given to particular fiber identification. Often several dyes are used to give a fiber a desired color. Individual fibers can be colored prior to being spun into yarns. Yarns can be dyed, and fabrics made from them can be dyed. Color can also be applied to the surface of fabric, as found in printed fabrics. How color is applied and absorbed along the length of the fiber are important comparison characteristics. Color-fading and discoloration can also lend increased value to a fiber association.



Cross-sectional views of nylon carpet fibers as seen with a scanning electron microscope (SEM)

Fiber Number

The number of fibers on the clothing of a victim identified as matching the clothing of a suspect is important in determining actual contact. The greater the number of fibers, the more likely that contact actually occurred between these individuals.

Fiber Location

Where fibers are found also affects the value placed on a particular fiber association. The location of fibers on different areas of the body or on specific items at the crime scene influences the significance of the fiber association

4.8.4. Evidence pertaining to Soil

The examination of soil and sand is important in criminal cases to prove or disprove the presence of a suspect or an object at the scene of crime. This evidence might lead to successful investigation of crimes like murder, rape, dacoity, hit and run cases etc.

The constituents of mineral and organic contents of soils show differences within a short distance at the scene of crime. The significant difference in the various soils is the difference in the color. The soil and the sand samples are usually collected in criminal cases from the clothes, shoes, tools, weapons, motor vehicle etc. to link the criminal with a crime. The trace materials from these articles are to be collected carefully so that the physical evidence, which is valuable in the detection of crime, is not lost. The following precautions are to be observed for the collection of trace evidence of soil and sand.

- If wet soil or sand is present on shoes, clothes, vehicles and other artifacts, it should be dried before being packed.
- In order to avoid contamination, different exhibits should be wrapped separately.
- If oil, grease and other sticky material were found to adhere to the clothes, shoes, etc. they should be kept in leak proof glass or plastic containers.

- If loose soil, dust, glass, etc. are found they should be packed separately in leak proof containers like plastic jars, vials etc.
- For trace material like glass, dust, soil etc. envelopes should not be used.
- The packing of the evidence should be so thorough that further breakage of the physical evidence should not take place in transit.

It should be kept in mind that when an exhibit containing trace evidence is found at the scene of crime, several specimen samples from immediate vicinity should be collected to enable the laboratory to compare the physical evidence. Such representative specimen would ensure whether the physical evidence collected belonged to the scene of crime or otherwise.

Samples of mud and grease from the frame and the mudguards of the automobiles form important physical evidence in the hit and run cases. The physical evidence found at the scene of occurrence or on the body of the deceased could be compared with those on the suspected vehicle in order to link the vehicle to the crime. In cases of burglary, dacoity and theft, several materials like traces of plaster, dust, fibers, glass etc. also may be found as physical evidence in such cases. If the materials on the clothing of the suspects are microscopic, they maybe collected by means of a special vacuum cleaner containing pouches for collection of such minute evidence.

Physical evidence collected from the scenes of crime, especially sand and soils, can be compared with the representative samples collected from the scene of crime by means of density gradient analysis technique, where various particles like sand, organic material like humus, get separated depending on their density. This is the simplest and accurate method in the analysis of soil and sand. In addition to this method, the trace evidence also can be examined by means of a spectrograph to find out the elemental composition in various samples of sand and soil, glass, paint flakes, metal pieces etc.



Density Analysis of Soil

For comparison of soils, density gradient tube method is found suitable especially when small quantities of soil from shoes, clothes etc. are collected in criminal cases. The method is rapid and highly sensitive.

Bromoform and nitrobenzene are mixed in different proportions and are placed carefully in narrow glass tubes of suitable sizes. The tubes have closed lower portions with open mouth. They are placed on stand in vertical position. The liquid mixture separates into various layers depending upon their relative densities. Equally measured soil samples are carefully placed in the tubes, each soil particle descends through the liquid and settles at various levels depending upon its density. After sometime,

a density gradient spectrum forms in the tubes, identical samples of soil appear at the same level and different soil samples settle at different levels.

CHECK YOUR PROGRESS

(I) Transfer of evidence at the crime scene is according to

- | | |
|-----------------------------------|------------------|
| 1) Locard's principle of exchange | 3) Both of these |
| 2) Principle of individuality | 4) None of these |

(II) Glass evidence can be examined using its

- | | |
|---------------------|------------------|
| 1) Density | 3) Both of these |
| 2) Refractive index | 4) None of these |

(III) Chronological documentation of the custody/disposition of evidence is

- | | |
|-------------------------|------------------------|
| 1) Chain of examination | 3) Chain of chronology |
| 2) Chain of custody | 4) None of these |

(IV) Crime scene examination incorporates

- | | |
|------------------------------|------------------|
| 1) Videotape and photography | 3) Written notes |
| 2) Sketching | 4) All of these |

Answers

- (I) 1
(II) 3
(III) 2
(IV) 4

4.9 SUMMARY

This unit highlights about types, significance and Classification of Physical and Trace Evidences. How to collect and submit the evidences in the laboratory is also described in the unit. The importance of chain of evidence and its relevance in a particular case is also emphasized. Reconstruction of crime scene plays a vital role in solving a particular crime. The aspect of reconstruction of crime scene is also included in this unit. Density, refractive index, conductivity and particle size has a significant role to perform in analyzing the trace evidences. Evidences pertaining

to glass, fiber, soil and tool marks can also lay a solid foundation to any legal case. These minute evidences can be of prime importance and should not be ignored.

SUGGESTED READINGS

1. B.B. Nanda & Dr. R.K. Tiwari, Forensic Science in India: A Vision for the Twenty first Century
2. James E Girard, Criminalistics, Forensic Science and Crime
3. Steven A Koehler, Forensic Epidemiology
4. VN Sehgal, Question Answers Criminology & Forensic Science
5. Edward M Robinson, Introduction To Crime Scene Photography
6. Barry A J Fisher, Introduction to Criminalities
7. Barbara G Conklin, Encyclopedia of Forensic Science
8. Stuart James, Forensic Science An Introduction to Scientific and Investigative
9. Barry A J Fisher, Techniques of Crime Scene Investigation
10. Dr. M S Rao, Dr. B P Maithil, Crime Scene Management, *A Forensic Approach*
11. Dr. (Mrs) Rukmani Krishnamurty, *An Introduction to FORENSIC SCIENCE In Criminal Investigation Techniques*
12. Dr. M S Rao, Dr. B P Maithil, Crime Scene Management, *A Forensic Approach*
13. G R Chatwal, Instrumental Methods of Chemical Analysis
14. Mozayani Ashraf, The Forensic Laboratory Handbook



U. P. RAJARSHI TANDON OPEN
UNIVERSITY

CFS-01

Certificate Course in Forensic Science

Block

2

QUESTIONED DOCUMENTS AND FINGERPRINTS

UNIT 5 3

SCOPE, DEVELOPMENT, DEFINITION AND NATURE OF
QUESTIONED DOCUMENTS

UNIT 6 7

DEVELOPMENT OF INDIVIDUALITY IN HANDWRITING

UNIT 7 16

FORGERIES AND LINE QUALITY DEFECTS

UNIT 8 28

FUNDAMENTALS AND PRINCIPLES OF FINGERPRINTING

Course Design Committee

Dr. P. P. Dubey Director, School of Agri. Sciences, UPRTOU, Allahabad	Coordinator
Dr. A. K. Gupta Dean, SHIATS, Deemed University, Naini, Allahabad	Member
Dr. H. C. Jaisawal Consultant UPRTOU, Allahabad	Member
Dr. Gurvinder Kaur Associate Professor Forensic Science Unit, Department of Chemistry Sri Guru Tegh Bahadur Khalsa College, University of Delhi, Delhi-110007	Member
Dr. G. S. Sodhi Associate Professor Forensic Science Unit, Department of Chemistry Sri Guru Tegh Bahadur Khalsa College, University of Delhi, Delhi-110007	Member
Dr. Vimal Rarh Assistant Professor Forensic Science Unit, Department of Chemistry Sri Guru Tegh Bahadur Khalsa College, University of Delhi, Delhi-110007	Member
Dr. Santosha Kumar Associate Professor School of Social Sciences, UPRTOU, Allahabad	Member
Dr. Shruti Assistant Professor School of Sciences, UPRTOU, Allahabad	Member Secretary
Dr. G K Diwedi Assistant Professor School of Education, UPRTOU, Allahabad	Member
Faculty Members, School of Sciences	
Dr. Ashutosh Gupta , Director, School of Science, UPRTOU, Prayagraj	
Dr. Shruti, Asst. Prof. , (Statistics), School of Science, UPRTOU, Prayagraj	
Ms. Marisha, Asst. Prof. , (Computer Science), School of Science, UPRTOU, Prayagraj	
Mr. Manoj K Balwant , Asst. Prof., (Computer Science), School of Science, UPRTOU, Prayagraj	
Dr. Dinesh K Gupta , Academic Consultant (Chemistry), School of Science, UPRTOU, Prayagraj	
Dr. Vikas Singh , Academic Consultant (Maths), School of Science, UPRTOU, Prayagraj	
Dr. Dharamveer Singh , Academic Consultant (Bio-Chemistry), School of Science, UPRTOU, Prayagraj	
Dr. R.P. Singh , Academic Consultant (Bio-Chemistry), School of Science, UPRTOU, Prayagraj	
Dr. Susma Chuhan , Academic Consultant (Botany), School of Science, UPRTOU, Prayagraj	
Dr. Deepa Chaubey , Academic Consultant (Zoology), School of Science, UPRTOU, Prayagraj	

Course Preparation Committee

Dr. G. S. Sodhi Associate Professor Forensic Science Unit, Department of Chemistry Sri Guru Tegh Bahadur Khalsa College, University of Delhi, Delhi-110007	Author
Dr. Gurvinder Kaur Associate Professor Forensic Science Unit, Department of Chemistry Sri Guru Tegh Bahadur Khalsa College, University of Delhi, Delhi-110007	Editor
Dr. Vimal Rarh Assistant Professor Forensic Science Unit, Department of Chemistry Sri Guru Tegh Bahadur Khalsa College, University of Delhi, Delhi-110007	Member

September, 2019

© Uttar Pradesh Rajarshi Tandon Open University.

ISBN 978-93-83328-08-6

All Rights are reserved. No part of this work may be reproduced in any form, by mimeograph or any other means, without permission in writing from the **Uttar Pradesh Rajarshi Tandon Open University**.

Printed and Published by Dr. Arun Kumar Gupta, Registrar, **Uttar Pradesh Rajarshi Tandon Open University, 2018.**

Printed By : Chandrakala Universal Pvt Ltd. 42/7 Jawahar Lal Neharu Road Allahabad-211002

UNIT - 5 : SCOPE, DEVELOPMENT, DEFINITION AND NATURE OF QUESTIONED DOCUMENTS

Structure

- 5.0 Introduction
- 5.1 Objectives
- 5.2 Definition of a document
- 5.3 Scope of Document examination
- 5.4 Forgery
- 5.4 Qualifications of a Forensic Document Examiner
- 5.5 Summary

5.0 INTRODUCTION

A document may be broadly defined as anything that bears marks, signs, or symbols, which have meaning or conveys a message to someone. There is a wide scope for document examination. It should be understood that questioned documents is a valid and legitimate field of study as a discipline in forensic examinations and identification.

5.1 OBJECTIVES

- Define a document
- Define the scope of document examination
- Describe the necessary qualification required to be a document expert

5.2 DEFINITION OF A DOCUMENT

A document may be broadly defined as anything that bears marks, signs, or symbols, which have meaning or conveys a message to someone.

5.3 SCOPE OF DOCUMENT EXAMINATION

- Identification of handwriting and signatures
- Identification of forgery
- Identification of typewriters, check writers, and photocopies
- Detection of alterations, additions, deletions, or substitutions
- Deciphering alterations and erasures
- Identification and deciphering of indented writing

- Comparisons of inks and identification of type of writing instrument

5.4. FORGERY

Below are the classes of forgery that are commonly encountered:

- No attempt is made by the forger to imitate the genuine signature of the person purportedly signing the document.
- There is an attempt to imitate the genuine signature by some method of tracing of a model signature.
- There is a freehand attempt to simulate the genuine signature from a model.
- The document and the purported signer are fictitious.
- A "cut & paste" job wherein a genuine signature, or copy thereof, is transferred from some authentic source to a fraudulent document.

Other disputed signatures include those which are genuine but which were disguised, or written in some illegible manner, by the writer for the purpose of later deniability; and signatures which, though genuine, the author either has no memory of executing or is unwilling to accept as genuine. It is possible for the document examiner to identify a document or signature as a forgery, but it is much less common for the examiner to identify the forger. This is due to the nature of handwriting in that, while the forger is attempting to imitate the writing habit of another person, the forger is, at the same time, suppressing his own writing habit, thereby disguising his own writing. In attempting to either disguise one's own writing or imitate that of another, the briefer the body of writing the easier it is to continue the disguise. As the writing becomes more extended, the greater the probability that one's own subconscious habit will intrude itself into the disguise attempt. There are no reliable methods of predicting from the writing whether the author was male or female, or right-handed or left-handed.

- **Identification of Typewriters and Check-writers**

With regard to typewriters, questions arise as to whether a series of documents were prepared on the same typewriter; what make/model of typewriter was used; or when was the typed document produced? Typewriters are identifiable as to make and model by means of class characteristics such as manual/electric, fabric ribbon/carbon film ribbon, typebars/daisywheel/ball element, typeface design, and so on. Machines may acquire individualizing characteristics to varying degrees due to use or misuse, damage, and general wear. The degree of success in a given case will vary with the type of machine with which the examiner is faced. Check-writers, also known as check protectors, may be identified as to manufacturer by its mechanism and typeface design, and individualized by accidental characteristics resulting from damage and wear and tear.

- **Identification of Indented Writing**

Indented writing is an imprint, which may be left on the underlying pages when the top sheet of paper is written upon. This impression of the writing is influenced by pen pressure and

thickness of the paper. Indented writing is very useful as a form of connecting evidence, such as typing a robbery note to a writing pad recovered from a suspect. Classically, indented writing was identified and deciphered by means of low angle oblique light and photography. More recently, an instrument known as an Electrostatic Detection Apparatus, or ESDA, is used to produce a visual image of the indented writing on transparency film. This procedure is non-destructive, and rather non-detectable.

- **Detection and Decipherment of Obliterations and Alterations:**

These examinations are performed in order to detect whether a portion of a document has been altered, some portion rendered not readily visible, or some text added. If an obliteration/alteration is identified, then the method is determined and described, and if possible the text of the obliterated entry deciphered. Instruments such as a Video Spectral Comparator (VSC) assist in this study. The VSC allows the examiner to examine the document through infrared illumination using an infrared sensitive camera as a detector. The image is examined by viewing on a monitor, and digital image processing through a computer. This is very useful in ink differentiation.

5.5 QUALIFICATIONS OF A FORENSIC DOCUMENT EXAMINER

A Forensic Document Examiner must have a sound basic education through the baccalaureate degree. The typical training period is two years of study and practical experience in an established questioned documents laboratory where the examiner trainee studies the basic literature, completes study projects, becomes familiar with the role of forensic sciences in general and questioned documents in particular as they relate to the legal system.

It should be understood that questioned documents is a valid and legitimate field of study as a discipline in forensic examinations and identification. It is not to be confused with "graphologists" or "grapho-analysts" who claim the ability to assess personality traits of a person from their handwriting. Whether the claim is valid or not, the association of these individuals with handwriting has caused some of them to claim sufficient expertise to determine whether or not a signature is genuine.

CHECK YOUR PROGRESS

1. What is meant by a document?
2. What falls under the purview of document examination?

5.7 SUMMARY

Document examination plays an important role in apprehending the criminals and solving legal crimes. The unit covers in detail the cases, which falls under the purview of document examination.

A document may be broadly defined as anything that bears marks, signs, or symbols, which have meaning or conveys a message to someone. It should be understood that questioned documents is a valid and legitimate field of study as a discipline in forensic examinations and identification.

UNIT-6 : DEVELOPMENT OF INDIVIDUALITY IN HANDWRITING

Structure

- 6.0 Introduction
- 6.1 Objectives
- 6.2 Handwriting Identification
 - 6.2.1 Handwriting
 - 6.2.2 Handwriting acquisition
 - 6.2.3 Process of underlying identification
- 6.3 Examination and comparison of handwritings
 - 6.3.1. Individual characteristics
 - 6.3.2. Circumstances for the production of handwriting
 - 6.3.3. What makes handwriting identification difficult?
 - 6.3.4. Factors affecting handwriting characteristics
- 6.4. Natural Variation and fundamental divergence
 - 6.4.1 The significance of variations between writers
 - 6.4.2. Pattern recognition techniques
- 6.5 Summary

6.0. INTRODUCTION

Handwriting is an acquired skill and clearly one that is a complex perceptual motor task, sometimes referred to as a neuromuscular task. More commonly, forensic scientists use handwriting analysis for two more limited and defined purposes. One is to authenticate documents such as records, diaries, wills, and signatures. The second purpose for which handwriting analysis is used is to link a specimen of handwriting with a crime suspect by comparing the suspect's handwriting with, for example, the handwriting on a ransom note or other communication linked to a crime. Class and individual characteristics plays a significant role in the identification of handwriting.

6.1. OBJECTIVES

- Define Handwriting
- Describe the characteristics of handwriting
- Explain examination and comparison of handwriting
- Define the natural variation in Handwriting
- Describe fundamental divergences in handwritings

6.2 HANDWRITING IDENTIFICATION

Handwriting identification is based on the principle that, while handwriting within a language tends to be alike to the degree that we can meaningfully read it, there are individual features that

distinguish one person's writing from that of another. Just as no two people are exactly alike, the handwritings of no two people are exactly alike in their combination of characteristics. There are, of course, natural variations within the handwriting of each individual. These variations must be closely and carefully studied by the examiner, so that he can distinguish between what is a "variation" and what is a "difference". The examiner must also be cognizant of the differences between "class characteristics" and "individual characteristics". Class characteristics are those, which are common to a group such as a particular writing system, family grouping, foreign language system, or professional group. Individual characteristics are those which are personal or peculiar letters or letter combinations, which, taken together, would not occur in the writing of another person. Handwriting identification is a comparison study requiring authenticated specimens of known handwriting from the individual(s) concerned. These are closely compared to the handwriting characteristics exhibited by the questioned writing in order to determine authorship. Like must be compared to like: printing-to-printing and cursive-to-cursive, with comparable letters, letter combinations, words, and numerals.

6.2.1 Handwriting

Handwriting is an acquired skill and clearly one that is a complex perceptual motor task, sometimes referred to as a neuromuscular task.

Skilled writing movements are so commonplace that one is inclined to overlook their complexity. Without exaggeration, however writing is one of the most advanced achievements of the human hand.

The hand is an extremely complex and delicate mechanism, containing some twenty-seven bones controlled by more than forty muscles. Most of the muscles are situated in the lower arm and connect to the fingers by an intricate set of tendons. Their ability in manipulating a writing instrument is precisely coordinated by a timing system under a neural control of movements of the arm, the hand, and the fingers. The precise ordering and timing of the movements determines the structure of the pattern i.e., recorded with the pen or pencils.

The development of writing is complex because, it is, in part, culture dependent, and cultures differ with locales and undergo constant change. The evidence of this dependence is manifested in class, system, or national characteristics.

Writing is a continuous or flowing task, not one of discrete or separated actions. There are apparent interruptions at word boundaries, but in many cases the pen movement may be continuous and uninterrupted, although not recorded as an inked line.

A feature of skill performance, and certainly of handwriting, is that it involves the movement occurs at its proper time and place in the sequence. The particular pattern of these movements constitutes the habitual aspects of writing that are peculiar to each individual. The fact that, with practice and skill, the execution of writing habits becomes more automatic renders the writing process less subject to conscious control.

6.2.2 Handwriting acquisition

There are two fundamental fields of study pertaining to handwriting:

1. The study of handwriting as a neuromuscular activity, its development as a skill and the effect upon it of various and external factors.
2. The study of handwriting identification as a discriminatory process.

Handwriting identification is a discriminatory process that derives from the comparison of writing habits and an evaluation of significance of their similarities or differences.

What has been commonly and frequently referred to as characteristics or writing features, or qualities are simplified manifestations of the habits formed. They are the discriminating elements of handwriting.

Writing characteristics have been commonly described as being of one of two types: class characteristics (the products of prescribed writing systems) and individual characteristics (the particular idiosyncrasies of the individual).

6.2.3 Process of underlying identification

The careful and systematic use of evidence, which is common to the many disciplines of forensic science, is directed toward the identification of an unknown. The process involves three distinct steps or stages:

1. *Analysis or discriminating element determination:* The unknown item and the known items must, by analysis, by examination or study, be reduced to a matter of their discriminating elements. These are the habits of behavior or of performances that serve to differentiate between products or people, which may be directly observable, measurable or otherwise perceptible aspects of the item.
2. *Comparison:* The discriminating element of the unknown, observed or determined through analysis, examination or study, must be compared with those known, observed, or recorded of the standard items.
3. *Evaluation:* Similarities or dissimilarities in discriminating elements will each have a certain value for discrimination purposes, determined by their cause, independence, or likelihood of occurrence. The weight or significance of the similarities or the difference of each element must then be considered and the explanation for them proposed.

Accordingly, we would suggest five respects in which a signature, or writing, may be judged to rate its intricacies or complexity:

1. The aggregate line length: Generally speaking, the longer the line, the more complex the design; there are of course some stylistic signatures that contain length of strokes of no purpose. We are not referring to this.
2. The number of pronounced directional changes in the line: When directional changes are angles in the vicinity of 180° they constitute retraces. When less than 90° they may be departure in straight-line movement or commencement of curves. If not the directional changes in writing will be due simply to allograph design.

3. The number of overwriting: Overwriting can be misleading stroke direction, and thus confusing as to allograph construction. These are two types retracing and superimposition. We define retracing as a line situated over another line, but is generated by pen motion in the opposite direction. A superimposition define a line situated over another line and is generated by pen motion in the same direction.
4. The continuity of the pen movement: It is based on continuation of pen, pen lift, pen pause, etc.
5. The repetition of well segregated, complex pen motion: Fluent and complex pen motion can be executed with ease but only when natural or practiced.

6.2.4 Class characteristics

The handwriting characteristics reflected in a group of individuals and are learnt by the child at the onset of learning to write. The style of writing, which is acquired by the learner, is what which is fashionable at the particular time and place. Following are the features, which are covered in class characteristics:-

- 1) Type of movement
- 2) Line quality
- 3) Speed and skill
- 4) Rhythm
- 5) Spacing between letters, word and line
- 6) Slant
- 7) Alignment
- 8) Connection and strokes between letters
- 9) Size and proportions of letters
- 10) Pen pressure, pen hold, pen position and pen shading
- 11) Coordination of writing muscles

6.3 EXAMINATION AND COMPARISON OF HANDWRITINGS

6.3.1. Individual characteristics

The writer with the passage of time acquires personal characteristics and each individual develops peculiarities in his handwriting some are consciously acquired for style and pictorial appearance or for convenience, while others habits become rooted in the writing process. The principle on which the individual handwritings characteristics are found in the handwriting are:

- 1) Identifying and differentiating characteristics which are most divergent from the regular copybook standard are of the most force.
- 2) Repeated characteristics, which are inconspicuous, should be first sought.
- 3) Characteristics those are modified or individualized by different writers in different ways. The curious physical twist in the formations of characters would show individualized characteristics of a writer.

6.3.2. Circumstances for the production of handwriting

Osborn and others have generally agreed that despite numerous similarities in two sets of writing a conclusion or identity can't be made if there are one or more differences in fundamental features of writing. There are some points suggested for this:

- i) Adequacy of standards
- ii) Accidental occurrences
- iii) Alternative styles
- iv) Ambidexterity
- v) Carelessness or negligence
- vi) Changes in health condition of writer
- vii) Changes in physical condition of writer
- viii) Changes in mental condition of writer
- ix) Concentration on the act of writing
- x) Disguise or deliberate change
- xi) Influence of Drugs or alcohol
- xii) Influence of medications
- xiii) Intentional change for later denial
- xiv) Nervous tension
- xv) Natural variation
- xvi) Writing condition – place or circumstances
- xvii) Writing instrument
- xviii) Writing position – including stance
- xix) Writing surface
- xx) Writing under stress

6.3.3 What makes handwriting identification difficult?

There are a number of circumstances that have an effect upon the conclusion, which can be drawn in handwriting studies and examination. These include:

- The qualitative insufficiency of the habits exhibited by the questioned material
- Wide variation in the standard from one writing occasion to the next
- The quantitative insufficiency of the habits that the questioned material contains
- Poor writing skill and degeneration of letter forms
- The unreliability of reproductions as a record of writing habits and of the character of the original document, when examination of the original is not possible
- The deliberate distortion or disguised of the questioned writing or of the writing standards
- An anomalous condition of the writer or circumstances of writing of the questioned document

A. Elements of Style

1. Arrangement

- Influenced by artistic ability, sense of proportion and instruction received.
 - The product of a group of habits.
2. *Class of Allograph*
 3. *Connections*
 - Interword.
 - Intraword.
 4. *Designs of Allograph and their Constructions*
 - Correspondence to foreign/domestic or particular writing systems.
 - Number, nature, position, sequence, and direction of strokes in letter composition.
 - Use of two or more forms for the same letter.
 - Capitalization – divergences from standard practices.
 5. *Dimensions*
 - Proportions of elements of letters, i.e., of bowls to the staffs, bodies to loops, of arches to loops.
 - Absolute sizes.
 - Relative sizes – of specific letters to specific letters,
 - According to position in words.
 6. *Slants or Slope*
 - Of the writing in general, and,
 - Of letters or parts of letter in particular.
 7. *Spacing*
 - Interword.
 - Intraword.

B. Elements of Execution

8. *Abbreviations*
 - Word contractions that eliminate letters.
 - Letter combinations that sacrifice form for speed.
9. *Alignment*

The relation of successive letter of a signature, a word or line of writing to an actual or imaginary base line.
10. *Commencements and Terminations*
 - Their length, direction, and path
 - Their taper (the abruptness with which the instrument approaches and leaves the paper)
11. *Diacritics and Punctuation – presence, style, and location.*
12. *Embellishments*
 - Including flourishes, ornamentation, rubrics, and underscores.
13. *Legibility or Writing Quality*
 - Ease of recognition of letter or adherence to copybook form.
14. *Line Continuity*
 - The presence/ absence of pen stops, pen lifts, or re-tracings.

15. *Line Quality*

- The degree of regularity (i.e., smoothness and /or gradation) to the writing stroke as is judged from the consistency of its nature and of its path in a prescribed direction. It varies from smooth and controlled to tremulous and erratic.

16. *Pen Control*

- Pen Hold
- Pen Position
- Point Load (pen pressure)
- To be considered if and when determinable.
- Evidenced by shading, greater deposition of ink or graphite or by the depression of the paper, Called rhythm, or fluency or a flowing hand when it materializes as a harmonious and graduated recurrence.
- Absolute – occurring in all writing.
- Relative – greater or lesser in some strokes.

17. *Writing Movement*

- Variants in the predominating action of the writing instrument. May be three-dimensional.
- Observed in letter formation and interword connections that may be:
 - Garlanded – anticlockwise movements predominate.
 - Arched – clockwise movements predominate.
 - Angular – straight lines take precedence to curves.
 - Indeterminable

C. Attributes of All Writing Habits

18. *Consistency or Natural Variation*

- The precision with which the habits are executed on repeated occasions.

19. *Persistency*

- The frequency with which a given habit occurs when the occasion permits.

D. Combinations Writing Habits

20. *Lateral Expansion*

- Ranges from contracted to expand.
- The product of spacing and letter formation.

21. *Word Proportions*

- Vertical dimension versus horizontal dimension.
- The product of size and spacing.

6.3.4. Factors affecting handwriting characteristics

1. Extrinsic: Physiological constraints, circumstantial, literacy and education, imitations, surface and texture of writing surface, type of pen, physical environment, etc.
2. Intrinsic: Physical health, mental health, temporal states (alcohol, drugs, and hypnosis), genetic factors, etc.

Handwriting can also be affected by other factors – injury, illness, medication, drug or alcohol use, stress, the writing surface, the writing instrument, or attempt disguise. It is the job of the document examiner to understand these factors as they might relate to a specific situation. The aim is to understand the relationship between mental status of an individual and his or her handwriting.

6.4. NATURAL VARIATION AND FUNDAMENTAL DIVERGENCE

6.4.1. The significance of variations between writers

All of these considerations, in addition to overall factors such as size, slope, line quality, and smoothness of curvature, provide an enormous potential to separate the block capital and cursive writings of one person from those of another. What makes this possible is the fact that with so many variables available in every letter, and so many letters available for comparison between the writings of any two people, there is no practical possibility that one will resemble in other every respect. Of course, such a coincidence is in theory possible, but to encounter it in practice can safely be discounted. However, this states the ideal position and refers to writings of a person as a whole. To say, then, that any one individual has a uniquely personal method of writing may be true, but to say that every piece of writing made by that person could not be matched by another person is not. How true this is for any one piece of writing depends upon the amount of material present and how unusual it is. Provided that a sufficient amount of material is present, the combination of features used by one person in his or her writing will be sufficiently different from the combination of features of any other person for any chance match to be found. If the amount of writing is smaller, the probability of coincidental match will be greater. There is, however, a difference between the same letters written at the beginning, at the end, or in the middle of the word, so a large amount of comparable material is available in most writing.

6.4.2. Pattern recognition techniques

The development of methods to read handwriting by machine has lead to application of these techniques to distinguish between the writings of different people. Computer based pattern recognition methods are extremely complicated, requiring specialist knowledge in a rather obscure field. Heights of upper loop and the areas within them can be compared, measured and data provided. Similarly, areas within circular letter and angularity can be calculated.

These methods have not yet entered the area of forensic documents examination to any extent. It appears that they will provide a method of retrieval of a similar writing from a large number of

samples in a collection; in Germany this has already begun. In the United Kingdom, research has been carried out into the use of such methods to authenticate signatures at points of sale. It seems unlikely that evidence in courts of law will be based on pattern recognition techniques anytime soon, if ever.

CHECK YOUR PROGRESS

1. What is Handwriting?
2. What is the principle on which handwriting identification is based?
3. What are two fundamental fields of study pertaining to handwriting?
4. What does Handwriting examination involves?

6.5 SUMMARY

Handwriting identification is based on the principle that, while handwriting within a language tends to be alike to the degree that we can meaningfully read it, there are individual features that distinguish one person's writing from that of another. Just as no two people are exactly alike, the handwritings of no two people are exactly alike in their combination of characteristics. Handwriting identification is a discriminatory process that derives from the compression of writing habits and an evaluation of significance of their similarities or differences. There is also a mention of natural variations and fundamental divergences in handwritings in this unit.

UNIT-7 : FORGERIES AND LINE QUALITY DEFECTS

Structure

- 7.0 Introduction
- 7.1 Objectives
- 7.2 Forgeries and line quality defects
- 7.3 Alterations in document
- 7.4 Disguised Handwriting
- 7.5 Anonymous Letters
- 7.6 Typescripts
- 7.7 Standard for comparison
- 7.8 Summary

7.0 INTRODUCTION

Forgery is the process of making, adapting, or imitating objects, statistics, or documents with the intent to deceive. Forgeries may be committed by writing by pencil or pen by type written matter by printing, or by engraving, by erasing or altering the contents of a document or by obliterating the original writing, etc. They are classified into different types depending on the manner in which they are carried.

7.1 OBJECTIVES

- Define natural variation in handwriting
- Describe forgeries and line quality defects
- Explain alterations in document
- Analyze disguised handwriting
- Expound on typescripts

7.2 FORGERIES AND LINE QUALITY DEFECTS

Forgeries may be committed by writing by pencil or pen by type written matter by printing, or by engraving, by erasing or altering the contents of a document or by obliterating the original writing, etc.

7.2.1. Types of forgeries

For the purpose of the subject of identification and comparison of signatures and writings forgeries may be classified as follows.

1. **Free hand forgery.** In this type of forgery, the forger selects a model signature or writing and he tries to copy the design of letters and other broad features depending upon his skill, practice, and competency.
2. **Traced forgery.** As the name indicates trace forgery is prepared by drawing the outline of a genuine signature by the process of tracing.
3. **Forgery by memory.** It refers to the signature or writing prepared from the material from the mental impressions of forms and letters of the signatures or writing prepared from the mental impressions of the forms of letters of the signatures of the actual writer and without any model signature or writing before the forger at the time of forgery.
4. **Forgery by impersonation.** When a person merely writes / signs the name of another person in his own hand writing in normal manner or in some modified manner, representing himself to be that person with some ulterior motive, such signature is a forgery.

7.2.2. Identification of forger. When an expert opines that a particular signature is a forged signature he is often asked to answer the question “who forged it”? In any forgeries a forger tends to leave his own hand writing habits to link him with the forgery in the process, however, the forger may leave few elements of his own habits in the forged signature which helpful to pin point him.

7.2.3. Alteration

Any change which gives the document a different effect from that which it originally possessed in termed as alteration. If the change is made after execution of a document and without the consent of the other party than such changes is called fraudulent alteration. The alteration may be caused by the addition, erasure, obliteration, cancellation, interlinking or substitution etc.

7.2.4. Obliteration

To obliterate means to blight out so as not be readily or clearly readable. Obliteration may be either intentional or unintentional. Writing may be intentionally obliterated to render them indecipherable by covering or obscuring with marking, overwriting, blots of ink or rubbing with pencil or carbon paper etc.

7.3 ALTERATIONS IN DOCUMENT

A Document can be altered in many ways, both intentionally and unintentionally. Something can be erased or crossed out. Or a person so inclined could add a < shape to a number "1" and make it a "4", thus changing the amount of a receipt or the date of a promissory note. Or it could be something as innocent as a teller's stamp accidentally placed over a date.

7.3.1. How to determine an alteration in the document?

Identifying document alterations requires focus, attention to detail and in some cases, forensic technology or expert assistance.

Document alterations can occur in a number of forms, including erasures, water damage, charring, ink differentiation and handwriting discrepancies.

Documents are altered for various reasons, ranging from simple corrections to intentional fraud. Alterations involving handwriting, erasures and water damage are easy to spot, but often require forensic equipment and expertise to fully analyze the cause or origin.

7.3.2 Erasures

The site of an erasure can be discovered and outlined by testing the surface of the paper which is invariably affected however the erasure was made. Erasure is effected either by abrasion which results in physical removal of writing or by chemical treatment.

Erasures can be basically divided into two groups:

- Physical erasure
- Chemical erasure

Physical Erasure. Physical removal of writing, impressions or part thereof may be accomplished by the abrasion of the surface of paper with the help of rubber erasure or sharp instruments such as razor blades, scalper, knife or Emory paper etc.

Chemical Erasures: Are those in which chemicals are used to erase some written document for his/her purpose. They may be acids or alkalis. Oxalic acid, potassium permanganate, etc. are examples of erasures. The chemical tests should never be applied on the document itself. A better way is to punch out small dots of paper from the affected area with the help of hypodermic needle and test them on microscope slide.

Deciphering erasures

Pencil Writing

- If there has been a partial erasure. The residual traces of the lead will assist in the interpretation of the impressions, which can be visualized with a low power stereoscopic microscope.
- Iodine Method– use of aqueous solution containing 0.35% iodine, 13.3% potassium iodide, 16.7% sodium chloride, 6.7% anhydrous aluminum chloride and 11.7% glycerine. The act of writing with a pencil will produce a local compression of the paper, which may result in differential absorption of iodine from aqueous solution of iodine in potassium iodide solution. The photograph the area to which the solution is applied as soon as any writing appears.
- Alcohol Method– moisten the paper with alcohol, which will intensify the color without causing it to spread unduly. Alcohol binds with the carbon present in the pencil writing.

Identifying a Chemical Erasure

1. Physical Test. Examination of reflectivity of surface of paper and its behavior in UV light and IR light.
2. Chemical Test. A combination of potassium thiocyanate and dilute Sulphuric acid reacts with the iron in the ink to give reddish brown ferrous sulphide. The document is photographed. Alternately, the document is fumed with hydrogen sulphide, which binds to iron in the ink to form iron sulphide.

7.3.3 Additions

Insertion of a modified clause or sentence may completely change the meaning of the document.

- Difference in writing material or handwriting
- Crude insert between lines
- Crowd along the margins

Detection is done by extensive study of document, by ink analysis or by ultraviolet/infrared spectral analysis.

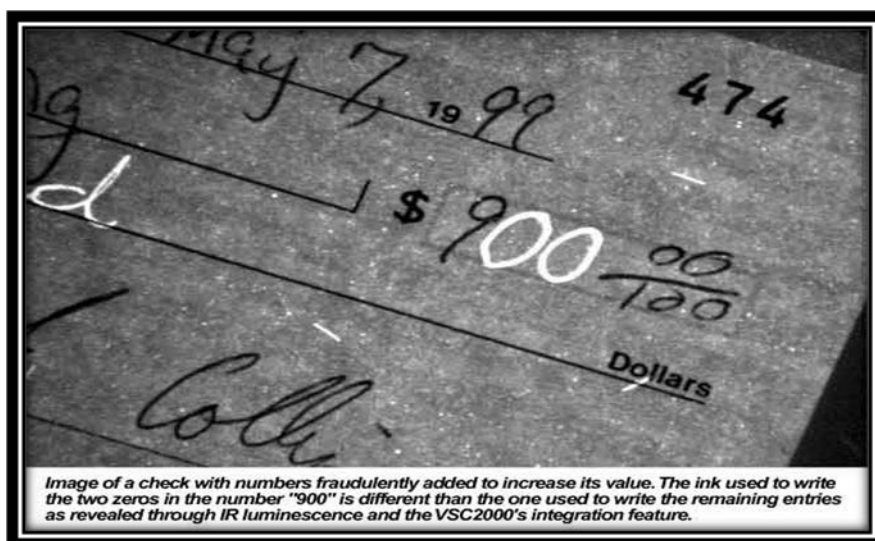

7.3.4. Obliterations

The obliteration or blacking out of portions of writing by some opaque material is seldom used for fraudulent purposes. The writing is crossed out with another writing instrument or completely written over by another writing instrument. Charring is a type of obliteration where a document is burned to

destroy the writing. Some inks and pencil leads will burn more slowly than papers, and the writing may be preserved and viewed under a strong or oblique light. Indented writing occurs when someone writes a document on the top sheet of a pad of paper. If the pen pressure is great enough, an image of the writing can be seen in the sheets underneath the top page where the document was written.

Sometimes a questioned document examiner is called upon to determine which of two pen strokes was made first when one overlaps the other. This is known as overwriting. This can usually be spotted using a stereomicroscope, especially if different colored pens made the two pen strokes.

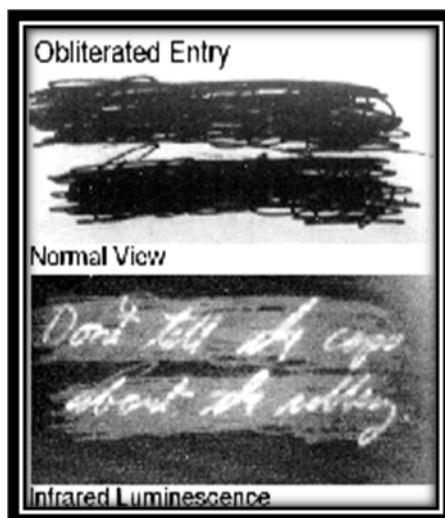

Methods to decipher Obliterations

- To penetrate the covering layer photographically under transmitted light so that original writing is revealed below it
- To remove obliterating material chemically or by some other means while original remains the same
- Photographic method is successful only when there is difference in color and composition of two materials.
- When obliterating color is black or same color pen then photographic method fails. In typewritten writing white outs are used
- Infra red sensitive films, ultraviolet light and Oblique Light may also be used to detect obliterations.

7.3.5. Overwriting

Documents may be changed by overwriting words and portions of sentences or by insertion of a character, a word, a sentence. At times it is necessary to attempt to determine what was originally written. In other instances it is necessary only to show that the changes were not made at the time of preparation of the document. Insertions in the form of interlineations may be very obvious but if it can be shown that another writer made them with another writing instruments. Or on a different typewriter, it can go a long way toward attacking the value of a present version.

A whole page may be inserted in a multiple page document. Their detection often depends upon study of binding marks such as staple holes, the paper for kind and size, the pen and ink, the typewriting, or the pencils. Indentations on a following page may be the key.

Detection of Overwriting

- Established by disclosing double strokes
- Different color of inks and writing instruments
- Different ink compositions
- Strokes drawn carelessly
- Detected under oblique light
- Any overlapping and changed intensity of strokes
- Traces of original ink beneath the overwritten strokes and differentiating inks
- Using low power microscope

7.4 DISGUISED WRITING

Writing, which is made with the least conscious attention to the structure of the writing, contains the following features:

- Smooth, unbroken strokes and rounded forms.
- Misplaced and misshapen i-dots and t-crosses.
- Letters tapered illegibly toward the end of words.
- Marked difference in pressure on upstrokes and down-strokes.
- Delicate pressure at beginning and ending strokes to letters.

Since, generally speaking, the more rapidly the writing is made the more natural it is, the following are also indications of naturalness when found in larger bodies of writing (say, a note or letter):

- Joining of initials or words.
- Wide writing and spacing.
- Simplification of forms, such as capitals.
- Absence of approach strokes to certain letters, for example, a, f, h, t, u, v, and w.

A word of caution: Some people write rather slowly, yet naturally, and it requires considerable skill to differentiate between the natural writing of a semi-literate person and an imitation of such a person's writing.

Reminder: In order to improve your own capability in learning to recognize natural writing, keep in mind the characteristics described above, especially the first five.

Since both tracings and careful freehand sketches must be made slowly, they will show some simulations of most of the following conditions:

- Slow, broken strokes, tremulous lines: a drawn appearance.
- Unnecessary retouching of strokes or letters.
- Blunt beginning and ending strokes.

- Lack of difference in pressure on upstrokes and downstrokes.
- Greater deliberation or care at the start of a name or word.
- Awkward looking forms.
- Meaningless blobs or marks.
- Frequent change in the angle of writing.
- Acute angles.
- Difference in speed within the writing.

Disguised writing attributes encompass a number of controlling factors and its success is directly related to the skill and the imagination of the subject and the amount of questioned writing involved. Most persons are able to alter some of their writing habits and most can successfully hide their identity in brief writings, such as a single signature. However, most are unable to maintain a disguise when they have to write a large amount of material, such as an entire letter or several exemplar forms. Therefore, it can be seen that if a single signature is questioned, the writer might be able to successfully mask his identity, while his chances of being identified increases as he continues to write. It should also be seen that if the exemplars are disguised, the more exemplars you obtain the greater the chances are that some of the writings will contain some of the normal characteristics of the writer.

One of the best things an investigator can do when taking exemplars is to have some non-requested specimens of the person to compare with the requested specimens. These will enable him to see if there is any obvious differences between these collected specimens and the requested writings. When most persons who are giving a disguised specimen are confronted with a naturally written specimen, they will discontinue the attempted disguise.

Some of the elements frequently found in disguised writings were identified by Ed Alford and are listed below:

- a. Failure to change speed of execution
- b. Slant or slope change
- c. Use of the awkward hand
- d. Use of hand printing
- e. Size change
- f. Arrangement changes
- g. Angularity change
- h. Spacing change
- i. Spelling changes
- j. Altered approach strokes
- k. Altered terminal strokes
- l. Altered extensions/upper and lower cased
- m. Capital letters style change
- n. Lower case style change
- o. Use of a circular i-dot or period
- p. Changes in numerals

An examination of these findings indicates that persons use many different methods, alone or in combination, to affect a disguise.

- **Unaccustomed Hand**

The use of the awkward hand is treated separately because this type of disguise contains some characteristics not normally found in disguised writings by the practiced or normally used hand. The term “unaccustomed hand” means that hand with which the writer has the least skill or the hand that he used little or not at all for normal writing but might use in an emergency or for purposes of disguise.

The use of the unaccustomed hand for producing fraudulent writings, say, for writing an unauthorized endorsement on a check, is not as common as it might be, probably because the writer believes he would become conspicuous by his awkwardness, or it may be that the writer believes that the product of his unaccustomed hand can be identified as readily as the product of the other hand. In many instances, this is not true; that is, such writings often do not provide a basis for a positive identification. There are, of course, some habits that will be revealed in this class of writing, for example, size relationships within a letter and relative heights of letters and the approximate form of most letters. As will be seen, however, there are modifications of some habits and at least a partial obscuration of others.

Characteristics of writing made with the unaccustomed hand are as follows:

- Low level of control
- Abrupt directional change
- Uncertain movements
- Acute angles in connecting strokes
- Poor line quality
- Upright slant
- Failure to round letters

Disguised handwriting, which is deliberately written in a style to which the writer has not become accustomed, cannot have the fluency and rhythm associated with a “normal hand”.

Handwriting can exhibit its best rhythm only when it has been executed to a great part as a reflex movement, without conscious thought having to be given to the details of its structure. The greater the effort and concentration necessary to form the disguised script, the greater will be the extent to which it has departed from its original fluency and rhythm.

7.5 ANONYMOUS LETTERS

An anonymous letter is without any acknowledged name, as that of author, contributor or may be the letter sent from the unknown person without any name.

Collection of material for investigation:

- Unopened letter

- Envelops
- Reading aloud

Classification based on motive



- **Blackmailing letters**

If a blackmailing letter is to be taken seriously at its face value it should fulfill the following conditions.

- The blackmailing to be within the capacity of the victim to pay may reasonably think the sum of money demand.
- There should be practicable instructions whereby the money is to pass from the victim to the blackmailer.
- A genuine blackmailing letter should contain a hint, if nothing more definite, of some reason why the victim should be called upon to pay.
- No genuine blackmailing letter is completely without the promise that the current demand is positively and definitely the last, and that if it is promptly complied with no more will ever be heard of the matter.

- **Threatening letters**

These are fairly common, but if legal proceeding are contemplated when the author has been identified, it is important to distinguish between those threats which are real and intended to terrorist, and others which are so extravagant that the writer is never likely to implement them.

- **Letters of revenge**

A desire for revenge is the motive behind a large proportion of anonymous letters.

Included in this group are the "tip-off" letters sent to the police, tax officials, customs and excise, and to those in authority in business and other organizations .

- Letters of recommendation
- Spiteful letters
- Note left at the scene of crime

- **Fingerprints on anonymous letters**

- It is only on the rarest occasion that fingerprint of any value are found on anonymous letters.
- There is little point in trying to develop prints with powders.

7.6. TYPESCRIPTS

Questioned typewriting can occasionally be identified with the typewriter that produced it. This is most common when the typewriter is a type-bar machine. The identification can sometimes be based on individual characteristics that develop during the manufacturing process and through use and abuse of the typewriter. Typewriters with interchangeable elements (ball, printwheel, or thimble), and carbon film or correction ribbons, can sometimes be associated with specific texts by examining individual characteristics of the elements and by correlating the text and ribbons.

Comparison of questioned typewriting with reference samples can sometimes determine a possible make and model of the typewriter and/or the typewriter elements. Carbon film typewriter ribbons can sometimes be read for content or specific wording of questioned material. Carbon film ribbons can be identified with questioned typewritten impressions. Fabric ribbons used more than once cannot be read.

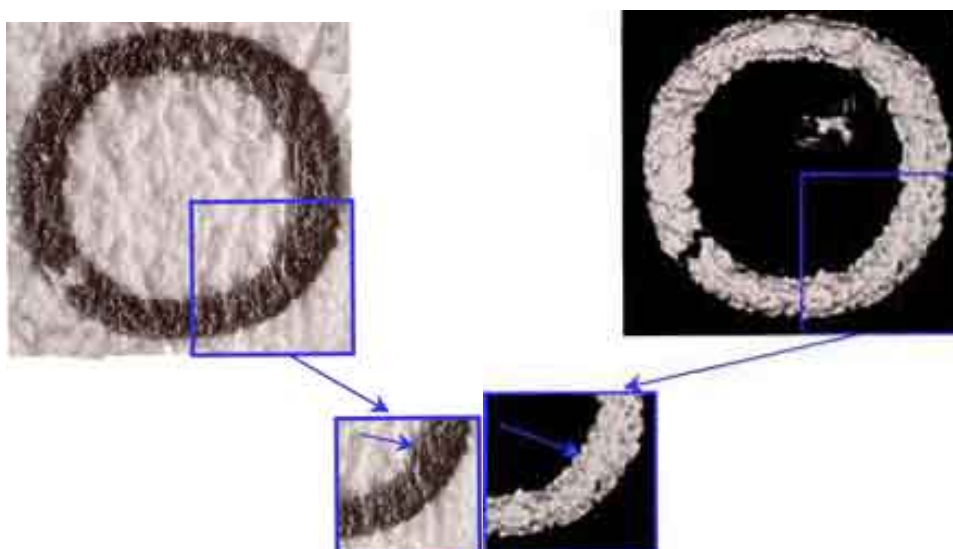

Paper is composed of numerous fibers. The randomness of the paper fibers is an identifying characteristic that makes fiber designs unique to a paper sample. The transfer of fiber designs can link a typewriter ribbon to typed text, which enables examiners to positively link a ribbon to text on a document. In the examples above, carbon was transferred (left) when the typeface struck the ribbon to the paper. A reverse transfer of the paper fiber design (right) is made on the plastic ribbon from the pressure exerted by the typeface.

7.7 STANDARD DOCUMENTS FOR COMPARISON : OBTAINING STANDARDS FOR COMPARISON IN HANDWRITING CASES

7.7.1. Dictated or Request Writing

Request or dictated writing samples are obtained from a subject for comparison with disputed documents. The subject is told what to write and is fully aware that the samples will be used for analysis. This type of sample should be obtained from all individuals suspected of involvement

whether or not a confession has been obtained. A sufficient number of dictated samples must be obtained so the writing habits of an individual can be established.

Subjects should not be permitted to handle or inspect the questioned documents prior to giving samples. The text of the document, including what signature(s) to write, should be dictated to the subject. It is important to remember that the questioned and known writing must be comparable (i.e. an A cannot be compared to a B, John Smith cannot be compared to Mary Jones). In addition, the style of writing must also be comparable. In most instances, cursive or connected script can only be compared to similar cursive writing. Handprinted (or manuscript) writing can only be compared to handprinted writing. In true name cases, always supplement the request/dictated signatures with copies of driver's license signatures and other documents not prepared for investigation.

The following guidelines for the number of samples to obtain are not rigid. Providing that the subject is willing to give samples, the number of samples should exceed the recommended number.

- Checks – 10 to 15 repetitions
- Signature/Check Endorsements – 20 to 30 repetitions (include account numbers and any notations)
- Extended Writing – 3 to 5 samples
- General Handwriting Form – in addition to the above, always have subjects complete a general handwriting form. The form should be written in the style of the questioned document, either cursive or printed. This form should always be completed first before obtaining direct text samples.

7.7.2. Collected Writing

As the term implies, collected writing is collected or gathered for handwriting comparisons when a subject refuses to voluntarily provide dictated samples. For example, an employment application could be used to compare with an anonymous threatening letter. The following are possible sources of collected writing.

Bank signature cards; identity cards; credit card receipts; jail forms; inmate request/complaint forms; copy of driver's license; college notes and tests; hospital records; traffic tickets etc.

CHECK YOUR PROGRESS

- (I) Which of these is a forgery:
- | | |
|------------------------------|----------------------|
| 1. Simulated signature | 3. Disguised writing |
| 2. Alterations in a document | 4. All of these |
- (II) Standard document may be
- | | |
|--------------|------------------|
| 1. Dictated | 3. Both of these |
| 2. Requested | 4. None of these |
- (III) Additions in a document can be determined by
- | | |
|------------------|---------------|
| 1. ESDA | 3. VSC |
| 2. None of these | 4. Spot tests |

Answers

(I) 4

(II) 3

(III) 3

7.8 SUMMARY

Forgeries may be committed by writing by pencil or pen by type written matter by printing, or by engraving, by erasing or altering the contents of a document or by obliterating the original writing, etc. The unit also highlights various types of forgeries and line quality defects. We have also mentioned about the alterations in the documents, which may be caused by the addition, erasure, obliteration, cancellation, interlinking or substitution etc. Erasure is effected either by abrasion which results in physical removal of writing or by chemical treatment.

Erasures can be basically divided into two groups:

- Physical erasure
- Chemical erasure

Various test used for the detection of erasures were also discussed in this unit. The unit also covers additions, obliterations over-writing, disguised writing and anonymous letters.

UNIT-8 : FUNDAMENTALS AND PRINCIPLES OF FINGERPRINTING

Structure

- 8.0. Introduction
- 8.1. Objectives
- 8.2. Principles of fingerprinting
- 8.3. Classification of fingerprints
- 8.4. Latent fingerprints and their development
- 8.5 Summary

8.0 INTRODUCTION

The science of fingerprinting is based upon the fact that no two fingers have yet been found to possess same pattern/print. Fingerprints are the reproduction of the friction ridges present on the palmar side of fingers and thumbs. These are sometimes known as "epidermal ridges" which are caused by the underlying interface between the dermal papillae of the dermis and the inter-papillary pegs of the epidermis. Fingerprints can be classified into three basic types– arches loops and whorls that make its classification possible. There are several methods deployed for the development of latent fingerprints.

8.1 OBJECTIVES

- Define what are fingerprints?
- Describe various principles underlying the science of fingerprinting
- Classify fingerprints into various patterns
- Develop latent fingerprints using various methods

8.2 PRINCIPLES OF FINGERPRINTING

▶ **First Principle:**

A fingerprint is an individual characteristic. No two fingers have identical ridge characteristics.

▶ **Second Principle:**

A fingerprint will remain unchanged during an individual's lifetime.

▶ **Third Principle:**

Fingerprints have general ridge patterns which make it possible to systematically classify. There are three main patterns of fingerprints: Arches, whorls and Loops.

- Arches: 5 % population
- Loops: 60 - 65 %

- Whorls: 30 - 35 %

8.2.1. Arches

Arches are found in about 5% of fingerprint patterns encountered. The ridges run from one side to the other of the pattern, making no backward turn. Ordinarily, there is no delta in an arch pattern but where there a delta, no re-curving ridge must intervene between the core and delta points. There are two types of arch patterns: plain arches and tented arches. Plain arches have an even flow of ridges from one side to the other of the pattern, no “significant up thrusts” and the ridges enter on one side of the impression, and flow out the other with a rise or wave in the center. Tented arches have an angle, an up thrust, or two of the three basic characteristics of the loop. They don’t have the same "easy" flow that plain arches do and particularly have “significant up thrusts” in the ridges near the middle that arrange themselves on both sides of a spine or axis towards which the adjoining ridges converge and appear to form tents.

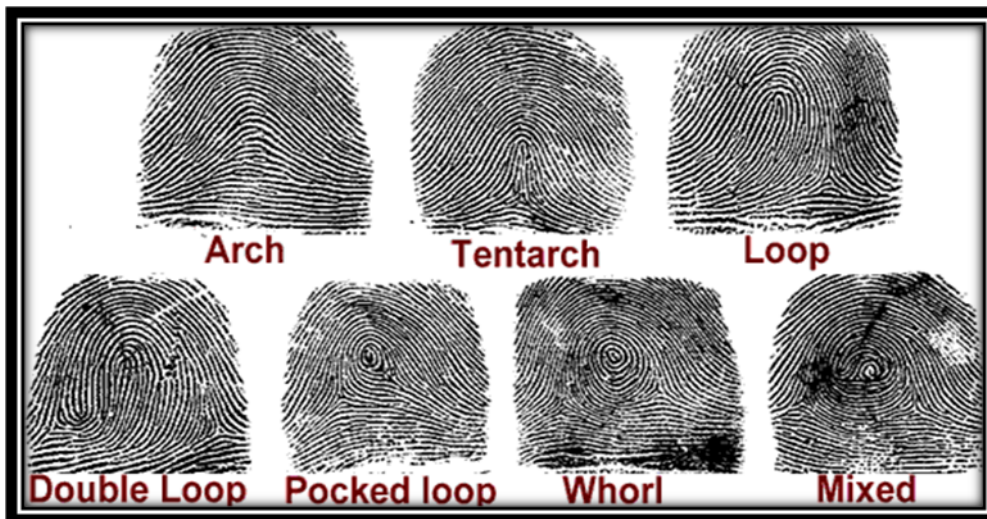

8.2.2. Loops

Loops occur in about 60-65 % of fingerprint patterns encountered. One or more of the ridges enters on either side of the impression, re-curves, touches or crosses the line running from the delta to the core and terminates on or in the direction of the side where the ridge or ridges entered. Each loop pattern has is one delta and one core and has a ridge count. Radial loops are named after the radius, a bone in the forearm that joins the hand on the same side as the thumb. The flow of the pattern in radial loops runs in the direction of the radius (toward the thumb). Radial loops are not very common and most of the time radial loops will be found on the index fingers. Ulnar loops are named after the ulna, a bone in the forearm. The ulna is on the same side as the little finger and the flow of the pattern in an ulnar loop runs in the direction of the ulna (toward the little finger).

8.2.3. Whorls

Whorls are seen in about 30-35% of fingerprint patterns encountered. In a whorl, some of the ridges

make a turn through at least one circuit. Any fingerprint pattern, which contains 2 or more deltas, will be a whorl pattern. There are four types of whorl patterns. Plain whorls consist of one or more ridges which make or tend to make a complete circuit with two deltas, between which an imaginary line is drawn and at least one re-curving ridge within the inner pattern area is cut or touched. Central pocket loop whorls consist of at least one re-curving ridge or an obstruction at right angles to the line of flow, with two deltas, between which when an imaginary line is drawn, no re-curving ridge within the pattern area is cut or touched. Central pocket loop whorl ridges make one complete circuit, which may be spiral, oval, circular or any variant of a circle. Double loop whorls consist of two separate and distinct loop formations with two separate and distinct shoulders for each core, two deltas and one or more ridges which make, a complete circuit. Between the two at least one re-curving ridge within the inner pattern area is cut or touched when an imaginary line is drawn. Accidental whorls consist of two different types of patterns with the exception of the plain arch; have two or more deltas or a pattern, which possess some of the requirements for two or more different types, or a pattern, which conforms, to none of the definitions.

8.3 CLASSIFICATION OF FINGERPRINTS

Types of Fingerprints

- **Latent prints.** Latent prints exhibit only a small portion of the surface of the finger and may be smudged, distorted, overlapping, or any combination, depending on how they were deposited.
- **Visible prints.** Visible Prints are friction ridge impressions of unknown origin, which are obvious to the human eye and are caused by a transfer of foreign material on the finger, onto a surface.
- **Plastic (or molded) prints.** A plastic print is a friction ridge impression from a finger or palm (or toe/foot) deposited in a material that retains the shape of the ridge detail.

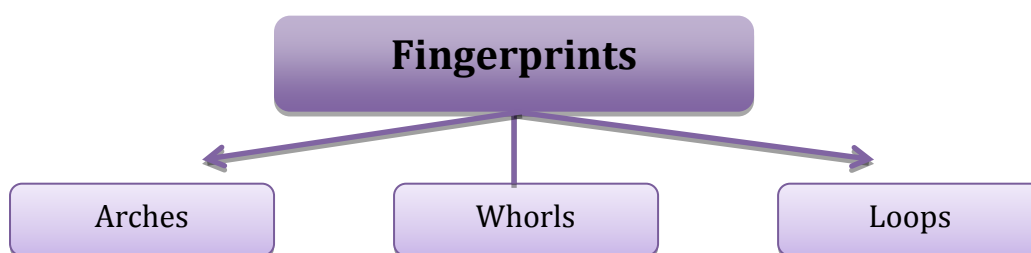

- **Plain and Rolled Prints**



Plain Print

Rolled Print

Plain prints are those, which are recorded by pressing an inked finger on a fingerprint recording card. For recording rolled prints, the inked finger is rolled nail edge to nail edge.

8.4. LATENT FINGERPRINTS AND THEIR DEVELOPMENT

Latent prints are such impressions, which are not directly visible to eyes. Such impressions are caused by sweat secreted by the sweat glands, which are found in abundance on palmar and plainer regions of the body.

How are latent prints formed ?

Papillary ridges leaving a deposit of sweat on the surface with which the fingers have been brought into contact usually form a latent print. These friction ridges are marked by regularly placed depressions called the sweat pores.

Perspiration exuding from these pores keeps the friction ridges of the skin well lubricated. Lubrication is caused due to the oily matter and fatty acids, which are secreted from the sweat pores. These secretions keep the hand smooth and soft otherwise the friction skin would become distorted during daily routine work.

Human sweat contains water along with volatile fatty acids, proteins, urea, organic matter, sodium and potassium chloride and phosphates as common content. Due to psychological effect the sweat gland becomes more activated when one is nervous or excited resulting in more perspiration than during normal time.

- **The visibility of latent prints depends upon following conditions and circumstances:**
- Physical condition of the skin of the criminal.
- The surface of contact.
- The angle of reflection of light used by the investigating officer.

- Time, temperature and other climatic factors.
- **Development of latent prints**

Locating a visible print or a plastic print at the scene of crime usually presents a little problem to the investigator because these prints are not visible to the eyes but locating the latent prints is obviously a much more difficult task and thus requires utilization of different techniques.

Latent prints may be found at a crime scene on non-porous articles. For example – tile, aluminum foil, plastic, glass, enameled surfaces etc. Besides numerous non-porous, non-adsorbent, hard and smooth surfaces are possible surfaces where latent prints may be found.

The main purpose in developing the latent prints is to make them visible so as to preserve them and compare them with the fingerprints of the suspect. The comparison takes into consideration the same ridge details in both the latent prints and the unknown prints. If the required numbers of points of similarity are noted down between the latent and the suspect prints, the identification is made.

Detection of latent fingerprints

Latent Fingerprints can often searched by the use of a flashlight placed over the surface of an object or at an angle. Thereafter these may be visualized by a suitable technique.

- **Powdering and lifting latent impressions**

In the search of latent prints different types of chemicals and powders are employed. A grey or black fingerprint powder is used in most of the cases. Black powder should be used for light colored and white objects. Grey powder for dark or black backgrounds. Grey powder is also used for development of latent prints on mirrors or reflecting surfaces. Dragon's blood may also be used on both light and dark surfaces. Fluorescent type of powder is used on multicolored surfaces.

- **Magnetic brush and powders**

Magnetic brush and powders are also used for the development of latent prints. The magnetic brush works with magnetic powders only which are available in many colors like grey, black, silver, fluorescent. The brush used is a magnetic rod, which is pushed in or out of a small cylinder and thus is created a magnetic field which causes the metal powder to appear as a brush. This brush is useful in dusting overhead and sloping surfaces for the development of latent prints. This brush is also used for locating prints on papers, tissues, leather, car, plastic, and other allied materials.

- **Chemical methods for developing latent prints**

There are many different chemical methods that have been successfully used in the development of latent prints.

- a. Iodine method
- b. Silver nitrate method
- c. Ninhydrin method

- **Iodine method**

In this process iodine fumes are used to develop latent prints. The fumes react with the perspiration and the fatty acids. Ridges of the print appear yellowish brown against the background.

Prints developed through iodine fumes are not permanent and begin to fade out after the fuming stops.

- **Silver nitrate method**

The development of fingerprint is dependent upon the fact that sodium chloride is present in perspiration, and hence in latent impression. It reacts with silver nitrate to form silver chloride, which is an unstable, white substance and darkens when exposed to light.

- **Ninhydrin method**

This method is effective on porous items like writing paper, wallpaper, envelopes, blotting paper, bank notes and certain fabrics. The older latent prints appear to be more responsive to ninhydrin than to silver chloride.

Ninhydrin reacts with longer remaining amino acids in the human perspiration.

The reaction of ninhydrin to the amino acids causes purple reddish brown stains.

CHECK YOUR PROGRESS

(I). Iodine method is used for developing latent print because:

- | | |
|------------------------------------------|----------------------|
| 1. It reacts with NaCl present in sweat | 3. It is inexpensive |
| 2. It reacts with amino acids and lipids | 4. None of these |

(II). Ninhydrin method is gives best result on:

- | | |
|------------|-----------------|
| 1. Steel | 3. Wet surfaces |
| 2. Plastic | 4. Paper |

(III) Type of print at the crime scene may be

- | | |
|------------------|------------------|
| 1. Plastic print | 3. Latent prints |
| 2. Visible print | 4. Any of these |

Answers

(I) 1

(II) 4

(III) 4

8.5 SUMMARY

This unit covers in depth the fundamental principles underlying the science of Fingerprinting. Fingerprints are the reproduction of the friction ridges present on the palmar side of fingers and thumbs. These are sometimes known as "epidermal ridges" which are caused by the underlying interface between the dermal papillae of the dermis and the inter-papillary pegs of the epidermis. Plain prints are those, which are recorded by pressing an inked finger on a fingerprint-recording card. For recording rolled prints, the inked finger is rolled nail edge to nail edge. Latent prints are not directly visible to eyes. Such impressions are also known as chance prints/ hidden prints/ scene of crime prints are caused by sweat secreted by the sweat glands, which are found in abundance on palmar and plainer regions of the body. The latent prints can be developed using various physical and chemical methods as explained in the unit.

SUGGESTED READINGS

1. Stephen E Petty, Forensic Engineering
2. Katherine M Kopenhaver, Forensic Document Examination, Principles and Practice
3. D Ellen, The Scientific Examination of Documents
4. Jens Borch, Handbook of Physical Testing of Paper
5. Mark R. Hawthorne, Fingerprints Analysis and Understanding
6. L C Jain, Intelligent Biometric Techniques in Fingerprint and Face Recognition
7. L A King, Forensic Chemistry of Substance Misuse
8. Mrs. S. Indira Sudha, Biometrics & Fingerprint Analysis 13
9. Nayar P S, Fingerprint Manual.
10. B. Lal & R Chandra, Cross-Examination of Handwriting Expert with Modern Techniques,10
11. Roy Huber, Handwriting Identification, Facts and Fundamentals
12. Ron Morris, Forensic Handwriting Identification Fundamental Concepts and Principle