



Uttar Pradesh Rajarshi Tandon

Open University

SBSCHE-01

ORGANIC CHEMISTRY – II (ADVANCE ORGANIC CHEMISTRY)

ORGANIC CHEMISTRY II (ADVANCE ORGANIC CHEMISTRY)

Block – 1

Unit – I – Electromagnetic Absorption Spectra	1 -36
Unit – II – Alcohols and Phenols	37- 71
Unit – III- Ether and Epoxide Ethers	72-87

Block – II

Unit – IV – Aldehydes and Ketones	88 - 138
Unit – V – Carboxylic Acids and Derivatives	139 -253
Unit – VI – Organic Compounds of Nitrogen	254 -320

SBSCH- 01- ORGANIC CHEMISTRY II (ADVANCE ORGANIC CHEMISTRY)

Curriculum Design Committee

Dr. P. P. Dubey, Director, School of Agri. Sciences, UPRTOU, Allahabad	Coordinator
Prof. Jagdamba Singh Dept. of Chemistry., University of Allahabad, Allahabad	Member
Prof. S.S. Narvi, Dept. of Chemistry., MNNIT, Allahabad	Member
Prof. Arun K. Srivastava Dept. of Chemistry., University of Allahabad, Allahabad	Member
Dr. Dinesh Kumar Gupta Academic Consultant-Chemistry School of Science, UPRTOU, Allahabad	Member Secretary

Course Preparation Committee

Dr. Dinesh Kumar Gupta Dept. of Chemistry, School of Science, UPRTOU, Prayagraj	Author (Block-1: Unit-01.02 and 03)
Dr. Ghansyam Mani Mishra Dept. of Chemistry, Handiya P.G. College, Handiya, Prayagraj, U. P. India	Author (Block-2: Unit-04,05 and 06)
Prof. Mrituanjay D. Pandey, Dept. of Chemistry, Institute of Science, Banaras Hindu University, Varanasi, U. P. India	Editor (Block-1: Unit-01.02 and 03)
Dr. R. B. Singh Dept. of Chemistry, Bareilly College, Bareilly	Editor (Block-2: Unit-04,05 and 06)
Dr. Dinesh Kumar Gupta, Academic Consultant- Chemistry, School of Science, UPRTOU, Prayagraj	SLM Coordinator

©UPRTOU , Prayagraj – 2020

SBSCH- 01 , Organic Chemistry –II (Advance Organic Chemistry)

ISBN –

©All right are reserved. No part of this work may be reproduced in any form, by mimeograph or any other means , without permission in writing form the Uttar Pradesh Rajashi Tandon Open University , Prayagraj , Printed and Published by Dr. Arun Kumar Gupta , Registrar, Uttar Pradesh Rajashi Tandon Open University -2020.

Printed By - K.C.Printing & Allied Works, Panchwati, Mathura - 281003.

SBSCHE- 01- ORGANIC CHEMISTRY II (ADVANCE ORGANIC CHEMISTRY) BLOCK-1

Unit 1: Electromagnetic Absorption Spectra

Electromagnetic Radiations, Electromagnetic spectrum and absorption of radiations. The Absorption Laws. UV-Visible spectrophotometer, formation of Absorption Band. Chromatophore Concept, Calculation of Absorption Maximum. Infra Red Spectroscopy Fundamental and Applications.

Unit 2: Alcohols and Phenols

Classification and nomenclature. Monohydric alcohols – nomenclature, methods of formation by reduction of aldehydes, Ketones, Carboxylic acids and Esters, Hydrogen bonding, Acidic nature, Reactions of alcohols. Dihydric alcohols – nomenclature, methods of formation, chemical reactions of vicinal glycols, oxidative cleavage [$\text{Pb}(\text{OAc})_4$ and HIO_4] and pinacolo-pinacolone rearrangement. Trihydric alcohols – nomenclature and methods of formation, chemical reactions of glycerol.

Phenols

Nomenclature, structure and bonding, Preparation of phenols, physical properties and acidic character. Comparative acidic strengths of alcohols and phenols, resonance stabilization of phenoxide ion. Reactions of phenols – electrophilic aromatic substitution, acylation and carboxylation. Mechanisms of Fries rearrangement, Claisen rearrangement, Gatterman synthesis, Hauben-Hoesch reaction, Lederer-Manasse reaction and Reimer- Tiemann reaction.

Unit 3: Ethers and Epoxide

Ethers

Nomenclature of ethers and methods of their formation, physical properties, Chemical reactions – cleavage and autoxidation, Ziesel's method. Williamson's synthesis, formation and cleavage of oxonium salts, elementary idea about crown ethers.

Epoxides

Synthesis of epoxides, Acid and base-catalyzed ring opening of epoxides, orientation of epoxide ring opening, reactions of Grignard and organolithium reagents with epoxides.

BLOCK-2

Unit 4: Aldehydes and Ketones

Nomenclature and structure of the carbonyl groups, synthesis of aldehydes and ketones with particular reference to the synthesis of aldehydes from acid chlorides, synthesis of aldehydes and ketones using 1,3-dithianes, synthesis of ketones from nitrites and from carboxylic acids. Physical properties. Mechanism of nucleophilic additions to carbonyl group with particular emphasis on benzoin, aldol, Perkin and Knoevenagel condensations, Condensation with ammonia and its derivatives. Wittig reaction, Mannich reaction. Use of acetals as protecting group, Oxidation of aldehydes, Baeyer-Villiger oxidation of Ketones, Cannizzaro reaction, MPV, Clemmensen, Wolff-Kishner, LiAlH_4 and NaBH_4 reductions. Halogenation of enolizable ketones. An introduction to α, β unsaturated aldehydes and ketones.

Unit 5: Carboxylic Acids and Derivatives

Nomenclature, structure and bonding, physical properties, acidity of carboxylic acids, effects of substituents on acid strength. Preparation of carboxylic acids, Reactions of carboxylic acids, Hell-Volhard-Zelinsky reaction, Synthesis of acid chlorides, esters and amides. Reduction of carboxylic acids, Mechanism of decarboxylation. Methods of formation and chemical reactions of halo acids, Hydroxy acids: malic, tartaric and citric acids. Methods of formation and chemical reactions of unsaturated monocarboxylic acids. Dicarboxylic acids: methods of formation and effect of heat and dehydrating agents.

Carboxylic Acid Derivatives

Structure and nomenclature of acid chlorides, esters, amides(urea) and acid anhydrides. Relative stability of acyl derivatives. Physical properties, interconversion of acid derivatives by nucleophilic acyl substitution Preparation of carboxylic acid derivatives, chemical reactions. Mechanisms of esterification and hydrolysis (acidic and basic).

Unit 6: Organic Compounds of Nitrogen

Preparation of nitroalkanes and nitroarenes. Chemical reactions of nitroalkanes. Mechanisms of nucleophilic substitution in nitroarenes and their reductions in acidic, neutral and alkaline media. Picric acid. Halonitroarenes: reactivity, Structure and nomenclature of amines, physical properties. Stereochemistry of amines. Separation of a mixture of primary, secondary and tertiary amines. Structural features effecting basicity of amines. Amine salts as phase-transfer catalysts. Preparation of alkyl and aryl amines (reduction of nitro compounds, nitrites), reductive amination of aldehydic and ketonic compounds. Gabriel-phthalimide reaction, Hofmann bromamide reaction. Reactions of amines, electrophilic aromatic substitution in aryl amines, reactions of amines with nitrous acid. Synthetic transformations of aryl diazonium salts, azo coupling.

UNIT 1: ELECTROMAGNETIC ABSORPTION SPECTRA

1.0 Introduction

Objective

1.1 Electromagnetic Radiations

1.2 Electromagnetic spectrum and absorption of radiations

1.3 The Absorption Laws

1.4 UV-Visible spectroscopy

1.5 Formation of Absorption Band

1.6 Chromatophore Concept

1.7 Calculation of Absorption Maximum

1.8 Infra Red Spectroscopy Fundamental and Applications

1.9 Summary

1.10 Terminal Questions

1.0 INTRODUCTION

An organic chemist uses spectroscopy as necessary tools for structure determination. Spectroscopy may be defined as the study of the interaction of electromagnetic radiations with matter. Electromagnetic radiations are produced by the oscillation of electric charge and magnetic field residing on the atom. There are various forms of electromagnetic radiation e.g. light (visible), ultraviolet (u.v.), infrared (i.r.), X-rays, microwaves, radio waves, cosmic rays etc.

Objectives

- **To define Electromagnetic Radiations**
- **Electromagnetic spectrum and absorption of radiations**
- **Absorption Laws**
- **UV-Visible spectroscopy**
- **Formation of Absorption Band**
- **Chromatophore Concept**
- **Calculation of Absorption Maximum**
- **Theory and application of IR Spectroscopy**

1.11 ELECTROMAGNETIC RADIATIONS

All types of radiations have the same velocity (2.998×10^8 m/s in vacuum) and require no medium for their propagation, i.e. they can travel even through vacuum. Electromagnetic radiations are characterized by frequencies, wavelengths or wave-numbers. Electromagnetic radiation includes or commonly refers to as 'light', radiation of longer and shorter wavelengths.

Frequency ν is defined as the number of waves which can pass through a point in one second, measured in cycles per second (cps) or hertz (Hz) ($1\text{Hz} = 1$ cps).

Wavelength λ is defined as the distance between two consecutive crests C or troughs T measured in micrometer (μm) or micron (μ) ($1 \mu\text{m} = 1, \mu = 10^{-6}\text{m}$), nanometer (nm).

Wavenumber $\bar{\nu}$ is defined as the number of waves which can pass through per unit length usually 1 cm. It is the reciprocal of wavelength expressed in centimeter (cm^{-1}).

$$\bar{\nu} = \frac{1}{\lambda}$$

By their definition,

$$\bar{\nu} \times \frac{1}{\lambda} \text{ or } \bar{\nu} = \frac{c}{\lambda}$$

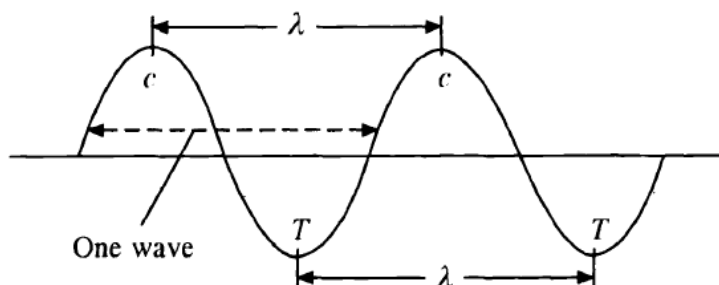

As the name implies it contains both an electric and a magnetic component which are best illustrated by considering plane-polarized (also known as linearly polarized) radiation. Illustrates one photon of such radiation travelling along the x axis. The electric component of the radiation is in the form of an oscillating electric field of strength E and the magnetic component is in the form of an oscillating magnetic field of strength H. These oscillating fields are at right angles to each other, as shown, and, if the directions of the vectors E and H are y and z respectively demonstrated in figure 1.0,

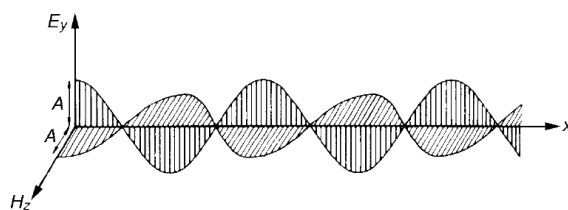

Figure 1.0: Plane-polarized electromagnetic radiation travelling along the x axis;
 E_y is the electric component and H_z is the magnetic component

Then,

$$E_y = A \sin(2\pi\nu t - kx)$$

$$H_z = A \sin(2\pi\nu t - kx)$$

Where, A is the amplitude.

Therefore, the fields oscillate sinusoidally with a frequency of $2\pi\nu$ and, because k is the same for each component, they are in-phase.

In a vacuum all electromagnetic radiation travels at the same speed, the speed of light c, and may be characterized by its wavelength λ , in air or vacuum or by its wavenumber $\bar{\nu}$ or frequency ν , both conventionally in a vacuum, where

$$\lambda = \frac{c}{\nu} = \frac{1}{\bar{\nu}}$$

A molecule may undergo rotational, vibrational, electronic or ionization processes, in order of increasing energy. A molecule may also scatter light in a Raman process and the light source for such an experiment is usually in the visible or near-ultraviolet region. An atom may undergo only an electronic transition or ionization since it has no rotational or vibrational degrees of freedom. Nuclear magnetic resonance (NMR) and electron spin resonance (ESR) processes involve transitions between nuclear spin and electron spin states, respectively.

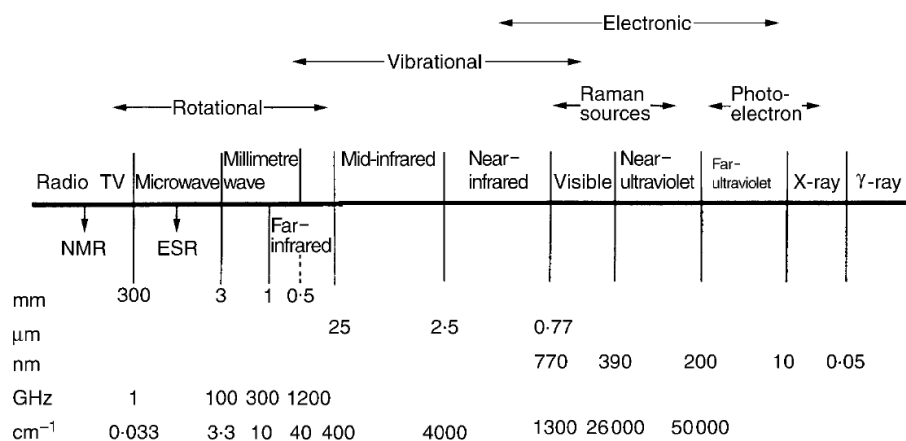

Regions of the electromagnetic spectrum

1.12 Electromagnetic spectrum and absorption of radiations

When electromagnetic radiations are passed through an organic compound, they may be absorbed to induce electronic, vibrational and rotational transitions in the molecules. The energy required for each of these transitions is quantized. Thus, only the radiation supplying the required quantum (photon) of energy is absorbed and the remaining portion of the incident radiation is transmitted. The wavelengths or frequencies of the absorbed radiations are measured with the help of a spectrometer. Generally, a spectrometer records an absorption spectrum as a plot of the intensity of absorbed or transmitted radiations versus their wavelengths or frequencies. Such spectra which are obtained by absorption of electromagnetic radiations are called absorption spectra and the spectra which are obtained by emission of electromagnetic radiations from the excited substances are known as emission spectra.

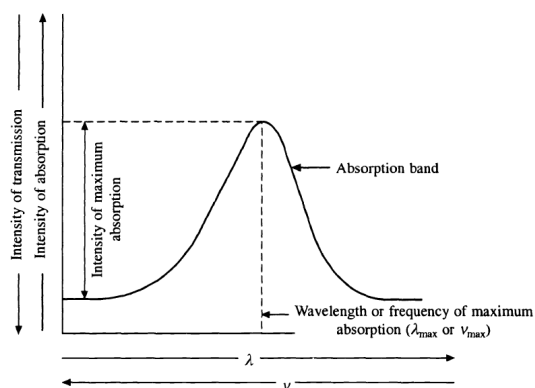

In an atom or molecule states m and n are stationary states, so-called because they are time independent. This pair of states may be for example- electronic, vibrational or rotational.

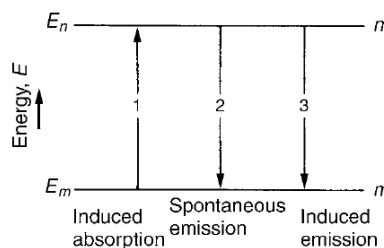

Figure 1.1: Absorption and emission processes between states m and n .

We consider the three processes that may occur when such a two-state system is subjected to radiation of frequency ν , or wave-number $\bar{\nu}$, corresponding to the energy separation ΔE where

$$\Delta E = E_n - E_m = h\nu = hc\bar{\nu}$$

Processes are:

1. Induced absorption, in which the molecular or atom absorbs a quantum of radiation and is excited from state m to n:

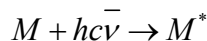

This is the absorption process, similarly illustrated by the appearance of an aqueous solution of copper sulphate as blue due to the absorption of the complementary colour 'red' by the solution.

2. Spontaneous emission, in which M^* (in state n) spontaneously emits a quantum of radiation:



3. Induced or stimulated emission, this is a different type of emission process from that of type 2 in that a quantum of radiation of wavenumber $\bar{\nu}$ given by Equation is required to induce or stimulate, M^* to go from n to m.

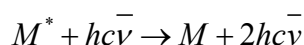

The process is represented by and may seem rather unusual to anyone used only to the spontaneous emission process. There is a useful analogy between induced emission, requiring the presence of radiation of the correct wave number for it to occur and the seeding of a cloud with silver iodide crystals in order to induce it to shed a shower of rain.

1.3 The Absorption Laws

The experiment is illustrated, where radiation of intensity I_0 falls on the absorption cell of length containing absorbing material of concentration c in the liquid phase. The radiation emerges with intensity I , and scanning the radiation through an appropriate wavenumber range of the absorption, say $\bar{\nu}_1$ to $\bar{\nu}_2$, and measuring $I_0 = I$ produces, the absorption spectrum typically measured as absorbance, defined as $\log_{10}(I_0/I)$. According to the Beer-Lambert law the absorbance A is proportional to c and ℓ ; so that

$$A = \log_{10}\left(\frac{I_0}{I}\right) = \epsilon \bar{\nu} c \ell$$

Since A is dimensionless, ϵ has dimensions of $(\text{concentration} \times \text{length})^{-1}$ and the units are very often $\text{mol}^{-1} \text{dm}^3 \text{cm}^{-1}$.

s

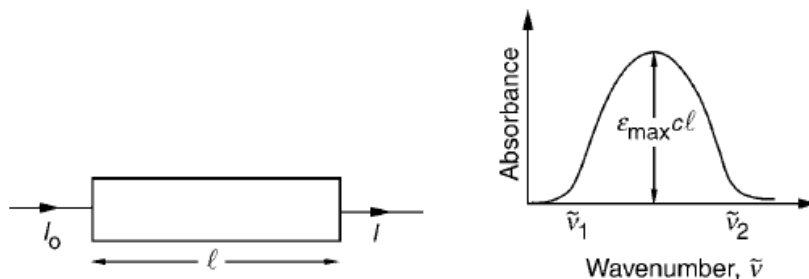
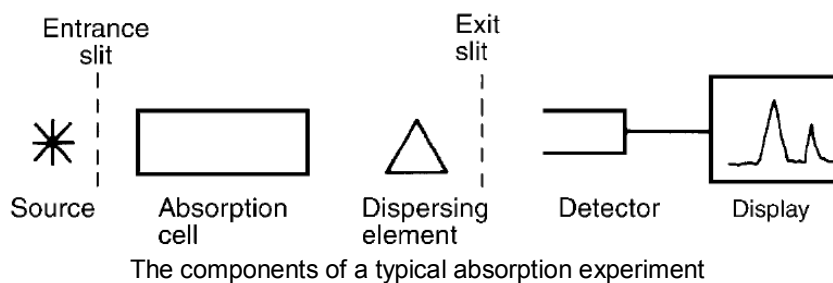

Figure (a) An absorption experiment. (b) A absorption band with the ϵ_{\max}



1.4 UV-Visible Spectroscopy

Ultraviolet and visible spectroscopy deals with the recording of the absorption of radiations in the ultraviolet and visible regions of electromagnetic spectrum. The ultraviolet region extends from 10 to 400 nm. It is subdivided into the near ultraviolet region (200-400 nm) and the far ultraviolet region (10-200 nm). The visible region extends from 400 to 800 nm. UV-visible absorption spectra originate from electronic transitions within a molecule. These transitions involving promotion of valence electrons from the ground state to the higher-energy state are called *electronic excitations* and are caused by the absorption of radiation energy in UV-visible regions of the electromagnetic spectrum.

Since UV and visible spectroscopy involves electronic transitions is often called *electronic spectroscopy*. Organic chemists use ultraviolet and visible spectroscopy mainly for detecting the presence and elucidating the nature of the conjugated multiple bonds or aromatic rings.

Instrumentation

UV-visible spectrophotometer compares the intensity of the transmitted radiation with that of the incident UV-visible radiation. Most UV-visible spectrophotometers are double-beam instruments and consist of a radiation source, monochromator, detectors, amplifier and recording system as shown in figure given below:

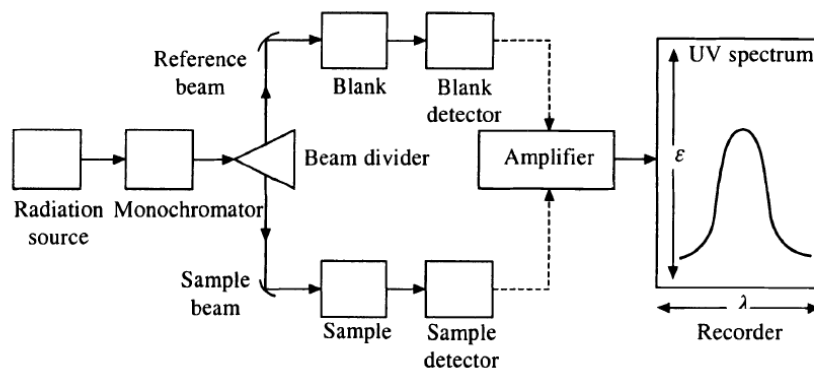

Radiation Source

The hydrogen-discharge lamp is the most commonly used source of radiation in the UV region (180-400 nm). A deuterium-discharge lamp is used in its place when more (3-5 times) intensity is desired. A tungsten-filament lamp is used when absorption in the visible region (400-800 nm) is to be determined.

Monochromator

It disperses the radiations, the most widely used dispersing element is a prism or grating made up of quartz because quartz is transparent throughout the UV range. Glass strongly absorbs ultraviolet radiation, hence it cannot be used in this region. The dispersed radiation is divided by the beam divider into two parallel beams of equal intensity; one of which passes through a transparent cell containing the sample solution and the other through an identical cell containing the solvent.

Detectors

These have photocells or photomultiplier tubes which generate voltage proportional to the radiation energy that strikes them.

Amplifier

The spectrophotometer has balancing electronic amplifier which subtracts the absorption of the solvent from that of the solution electronically.

Recorder

It automatically records the spectrum as a plot of wavelengths of absorbed radiations against absorbance (A) or molar absorptivity (ϵ).

Electronic Transitions

According to molecular orbital theory, the excitation of a molecule by the absorption of radiation in the UV-visible regions involves promotion of its electrons from a bonding or non-bonding (n) orbital to an antibonding orbitals. There are σ and n bonding orbitals

associated with σ^* and n^* antibonding orbitals, respectively. Non-bonding (n or p) orbitals are not associated with antibonding orbitals because non-bonding or lone pair of electrons present in them do not form bonds. Following electronic transitions are involved in the UV-visible region with following transitions:

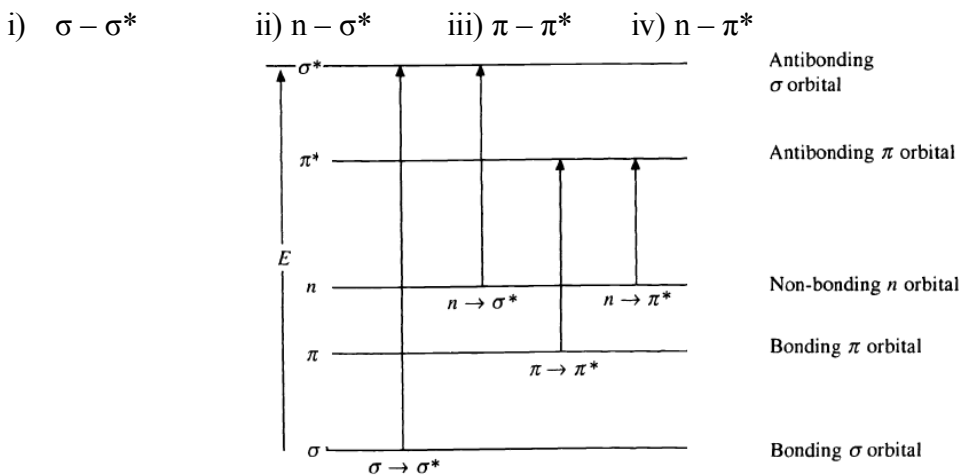

Energies of electronic transitions

The order of energy required for various electronic transitions is

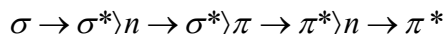

$\sigma \rightarrow \sigma^*$ Transition

The transition of an electron from a bonding sigma orbital to the associated antibonding sigma orbital is $\sigma \rightarrow \sigma^*$ transition. It is a high energy process because a bonds are generally very strong. Thus, these transitions do not occur in normal UV-visible regions (200-800 nm). For example, in alkanes only $\sigma \rightarrow \sigma^*$ transition is available and they absorb high energy UV radiation around 150 nm; ethane shows λ_{\max} 135 nm. The region below 200 nm is called *vacuum UV region*, since oxygen present in air absorbs strongly at $\lambda < 200$ nm and below. Similarly, nitrogen absorbs at $\lambda < 150$ nm and below. Thus, an evacuated spectrophotometer is used for studying such high energy transitions (below 200 nm).

$n \rightarrow \sigma^*$ Transition

The transition of an electron from a non-bonding orbital to an antibonding sigma orbital is designated as $n \rightarrow \sigma^*$ transition: Compounds containing non-bonding electrons on a heteroatom are capable of showing absorption due to $n \rightarrow \sigma^*$ transitions. These transitions require lower energy than $\sigma \rightarrow \sigma^*$ transitions. Some organic compounds undergoing

$n \rightarrow \sigma^*$ transitions are halides, alcohols, ethers, aldehydes, ketones etc. For example, methyl chloride

shows A_{\max} 173 nm, methyl iodide A_{\max} 258 nm, methyl alcohol A_{\max} 183 nm and water A_{\max} 167 nm.

In alkyl halides, the energy required for $n \rightarrow \sigma^*$ transition increases as the electronegativity of the halogen atom increases. This is due to comparatively difficult excitation of non-bonding (n or p) electrons on increase in the electronegativity. The difficult excitation means less probability of transition. The molar extinction coefficient ϵ : increases as the probability of the transition increases. Thus, methyl iodide shows A_{\max} 258 nm, E_{\max} 378 and methyl chloride A_{\max} 173 nm, E_{\max} -100.

$\pi \rightarrow \pi^*$ Transition

The transition or promotion of an electron from a π bonding orbital to a π^* antibonding orbital is designated $\pi \rightarrow \pi^*$ transition. These type of transitions occur in compounds containing one or more covalently unsaturated groups like C=C, C=O, NO₂ etc. $\pi \rightarrow \pi^*$ transitions require lower energy than $n \rightarrow \sigma^*$ transitions. In unconjugated alkenes, this transition occurs in the range 170-190 nm; ethylene shows A_{\max} 171 nm.

$n \rightarrow \pi^*$ Transition

The transition or promotion of an electron from a non-bonding orbital to a π^* antibonding orbital is designated $n \rightarrow \pi^*$ transition. This transition requires lowest energy.

1.4 Formation of Absorption Band

Since the energy required for each electronic transition is quantized, the UV-visible spectrum is expected to exhibit a single, discrete line corresponding to each electronic transition. In practice, broad absorption bands are usually observed. In a molecule, each electronic energy level (either in ground state or in excited state) is accompanied by a large number of vibrational (v_0 , v_1 , v_2 etc.) and rotational (r_0 , r_1 , r_2 , etc.) energy levels which are also quantized. In complex molecules having many atoms there are still a large number of closer vibrational energy levels.

The radiation energy passed through a sample is sufficient to induce various electronic transitions as well as transitions in accompanying vibrational and rotational energy levels. However, these transitions have very small energy differences, but the energy required to induce an electronic transition is larger than that required to cause transitions in the accompanying

vibrational and rotational energy levels. Thus, the electronic absorption is superimposed upon the accompanying vibrational and rotational absorptions resulting in the formation of broad bands.

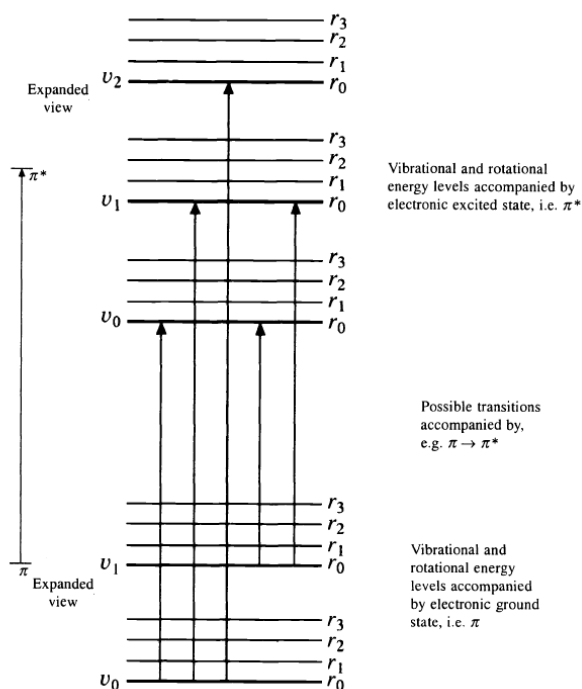





Schematic energy level diagram of a diatomic molecule

1.5 Chromatophore Concept

Chromatophores are pigment-containing cells or groups of cells, found in a wide range of animals including amphibians, fish, reptiles, crustaceans and cephalopods. Mammals and birds, in contrast, have a class of cells called melanocytes for coloration. Chromatophores are largely responsible for generating skin and eye colour in ectothermic animals and are generated in the neural crest during embryonic development. Mature chromatophores are grouped into subclasses based on their colour (more properly "hue") under white light: xanthophores (yellow), erythrophores (red), iridophores (reflective / iridescent), leucophores (white), melanophores (black/brown), and cyanophores (blue).

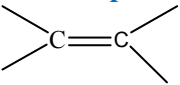
In terms of spectroscopy chromophore are covalently unsaturated groups responsible for absorption in the UV or visible region is known as a chromophore. For example, C=C, C=C, C=O, C=N, N=N, NO₂ etc. If a compound absorbs light in the visible region (400-800 nm), only then it appears coloured. Thus, a chromophore may or may not impart colour to a

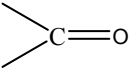
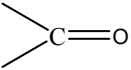
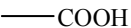
compound depending on whether the chromophore absorbs radiation in the visible or UV region. Chromophores like C=C or C=C having π electrons undergo $\pi-\pi^*$ transitions and those having both π and non-bonding electrons, e.g. C=O, C=N or N=N, undergo $\pi-\pi^*$, n- π^* and n- σ^* transitions. Since the wavelength and intensity of absorption depend on a number of factors, there are no set rules for the identification of a chromophore. Characteristics of some common unconjugated chromophores are given in Table below.

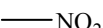
Chromophore	Example	λ_{\max} (nm)	Transition
	Ethylene	171	$\pi-\pi^*$
	Acetylene	150	$\pi-\pi^*$
	Acetaldehyde	160	n- σ^*
		180	$\pi-\pi^*$
		290	n- π^*
	Acetone	166	n- σ^*
		188	$\pi-\pi^*$
		279	n- π^*
	Acetic acid	204	n- π^*
	Acetamide	178	$\pi-\pi^*$
	Nitromethane	201	$\pi-\pi^*$
		274	n- π^*

Auxochrome

A covalently saturated group when attached to a chromophore, changes both the wavelength and the intensity of the absorption maximum is known as *auxochrome*, e.g. NH₂, OH, SH, halogens etc. Auxochromes generally increase the value of λ_{\max} as well as ϵ_{\max} by extending the conjugation through resonance. These are also called *colour enhancing groups*. An auxochrome itself does not show absorption above 200 nm. Actually, the combination of chromophore and auxochrome behaves as a new chromophore having different values of λ_{\max} and ϵ_{\max} . For example, benzene shows λ_{\max} 256 nm, ϵ_{\max} 200, whereas aniline shows λ_{\max} 280 nm, ϵ_{\max} 1430 (both increased). Hence, NH₂ group is an auxochrome which extends the conjugation involving the lone pair of electrons on the nitrogen atom resulting in the increased values of λ_{\max} and ϵ_{\max} .

Absorption and Intensity Shifts

Bathochromic Shift: The shift of an absorption maximum to a longer wavelength due to the presence of an auxochrome or solvent effect is called a *bathochromic shift* or *red shift*. Example: Benzene shows λ_{\max} 256 nm and Aniline shows λ_{\max} 280 nm. Thus, there is a bathochromic shift

of 24 nm in the λ_{max} of benzene due to the presence of the auxochrome NH_2 . Similarly, a bathochromic shift of $n-\pi^*$ band is observed in carbonyl compounds on decreasing solvent polarity, e.g. λ_{max} of acetone is at 264.5 nm in water as compared to 279 nm in hexane.

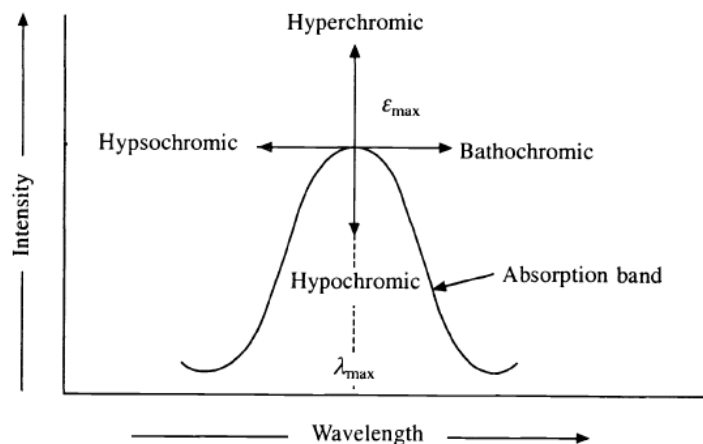

Shifts in absorption position and intensity

Hypsochromic Shift: The shift of an absorption maximum to a shorter wavelength is called *hypsochromic* or *blue shift*. This is caused by the removal of conjugation or change in the solvent polarity. Example: Aniline shows λ_{max} 280 nm, whereas anilinium ion (acidic solution of aniline) shows λ_{max} 254 nm. This hypsochromic shift is due to the removal of $n-\pi$ conjugation of the lone pair of electrons of the nitrogen atom of aniline with the n -bonded benzene ring on protonation because the protonated aniline (anilinium ion) has no lone pair of electrons for conjugation. Similarly, there is a hypsochromic shift of 10-20 nm in the A_{max} of $n-\pi^*$ bands of carbonyl compounds on going from ethanol as solvent to hexane, i.e. on decreasing solvent polarity.

Hyperchromic Effect: An effect which leads to an increase in absorption intensity ϵ_{max} is called *hyperchromic effect*. The introduction of an auxochrome usually causes hyperchromic shift. Example: Benzene shows B-band at 256 nm, ϵ_{max} 200, whereas aniline shows B-band at 280 nm, ϵ_{max} 1430. The increase of 1230 in the value ϵ_{max} of aniline compared to that of benzene is due to the hyperchromic effect of the auxochrome NH_2 .

Hypochromic Effect: An effect which leads to a decrease in absorption intensity ϵ_{max} is called *hypochromic effect*. This is caused by the introduction of a group which distorts the chromophore. For example, biphenyl shows λ_{max} 252 nm, ϵ_{max} 19,000, whereas 2,2'-

dimethylbiphenyl shows λ_{\max} 270 nm, ϵ_{\max} 800. The decrease of 18,200 in the value of ϵ_{\max} of 2,2'-dimethylbiphenyl is due to the hypochromic effect of the methyl groups which distort the chromophore by forcing the rings out of coplanarity resulting in the loss of conjugation.

1.6 Calculation of Absorption Maximum

Woodward-Fieser Rules for Calculating λ_{\max} in Conjugated Dienes and Trienes: In 1941 Woodward introduced empirical rules for calculating and predicting λ_{\max} for acyclic and six-membered dienes. Further, Fieser and Scott modified these rules with dienes and trienes. Summaries of both rules called Woodward-Fieser Rules.

Woodward-Fieser Rules for Calculating λ_{\max} in Conjugated Dienes and Trienes

Base value for acyclic or heteroannular diene	214nm
Base value for homoannular diene	253nm
Increment for each:	
Alkyl substituent or ring residue	5nm
Exocyclic conjugated double bond	5nm
Double bond extending conjugation	30nm
-OR (alkoxy)	6nm
-Cl,-Br	6nm
-OCOR (acyloxy)	0nm
-SR (alkylthio)	30nm
-NR ₂ (dialkylamino)	60nm
In the same double bond is exocyclic to two rings	
Simultaneously	10nm
Solvent correction	0nm
Calculated* λ_{\max} of the compound	Total = nm

For π - π^ transition (K-band).

Example 1: Calculate the wavelength of the maximum UV absorption for

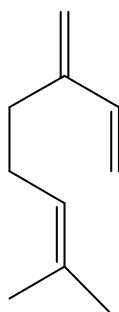

Myrcene

Since, it is an acyclic diene with one alkyl substituent, thus

Base value	214nm
One alkyl substituent	5nm
Calculated λ_{\max}	219nm
Observed λ_{\max}	224nm

Example 2: Calculate the value of λ_{\max} for β -phellandrene

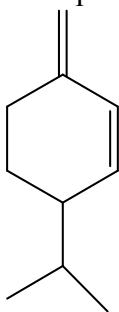

This is a heteroannular diene with conjugated double bonds are not in the same ring with two ring residues and one exocyclic double bond, hence

Base value	214nm
Two alkyl substituents (2 x 5nm)	10nm
One exocyclic double bond	5nm
Predicted λ_{\max}	229nm
Observed λ_{\max}	232nm

Example 3: Expected λ_{\max} values of compound

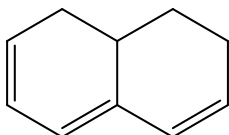

This is a homoannular diene with conjugated double bonds are not in the same ring with two ring residues and one exocyclic double bond, hence

Base value	253nm
Three alkyl substituents (3 x 5nm)	15nm

One exocyclic double bond 5nm
 Predicted λ_{\max} 273nm

Example 4: calculate the value of absorption maximum for the ethanolic solution of

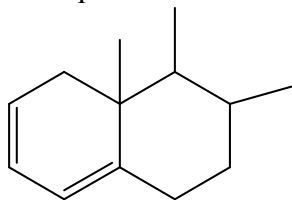

This is a homoannular diene with three ring residues and one exocyclic double bond, thus

Base value 253nm
 Three ring residues (3 x 5) 15nm
 One exocyclic double bond 5nm
 Calculated λ_{\max} 273nm
 Observed λ_{\max} 275nm

Example 5: Calculate λ_{\max} for the ethanolic solution of

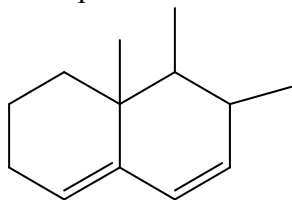

This is a heteroannular diene with three ring residues and one exocyclic double bond, thus

Base value 214nm
 Three ring residues (3 x 5) 15nm
 One exocyclic double bond 5nm
 Calculated λ_{\max} 234nm
 Observed λ_{\max} 235nm

Example 6: Calculate the value of absorption maximum for

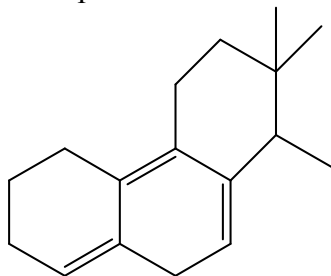

It contains both homoannular and heteroannular diene systems but the calculation of its will be based on the homoannular diene system. There are six ring residues attached to the carbon atoms of the entire conjugated system, one double bond extending conjugation, two exocyclic double bonds and one double bond exocyclic to two rings simultaneously. Thus, λ_{\max} of compound is calculated as:

Base value 253nm
 Six ring residues (6 x 5) 30nm
 One double bond extended conjugation 30nm

Two exocyclic double bond (2 x5)	10nm
One double bond exocyclic to two ring	
Simultaneously	10
Calculated λ_{\max}	333nm
SAQ1 Calculate λ_{\max} for the compound A and B	

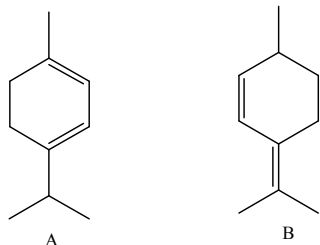

Solution:

For compound A

Homoannular diene	
Base value	253nm
Two ring residues (2 x 5)	10nm
Two alkyl substituents	10nm
Calculated λ_{\max}	273nm

For compound B

Heteroannular diene	
Base value	214nm
Two ring residues (2 x 5)	10nm
Two alkyl substituents	10nm
One exo cyclic bond	5nm
Calculated λ_{\max}	239nm

SAQ2- Predict the value of λ_{\max} (hexane) for

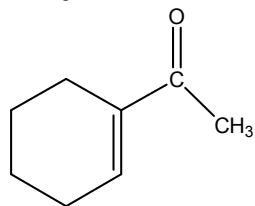

Hint:

This is a six-membered cyclic α,β -unsaturated ketone with one α - and one β alkyl substituents.

Hence,

Base value	215 nm
One α -alkyl substituent	10nm
One β -alkyl substituent	12nm
Predicted λ_{\max} (EtOH)	237nm
Observed λ_{\max} (EtOH)	249nm
Calculated λ_{\max} (hexane)	234nm
Solvent correction	+11nm
	248 nm

SAQ3: Calculate λ_{\max} (EtOH) for

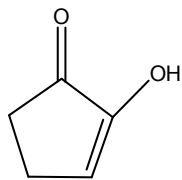

Hint:

It is a five-membered cyclic α,β -unsaturated ketone with one α -hydroxy and one β -ring residue.

Thus,

Base value	202nm
One α -hydroxy groups	35nm
One β -ring residue	12nm
Calculated A_{\max} (EtOH)	249nm
Observed A_{\max} (EtOH)	247nm

1.7 Infra Red Spectroscopy Fundamental and Applications

Infrared spectroscopy deals with the recording of the absorption of radiations in the infrared region of the electromagnetic spectrum. The position of a given infra red absorption is expressed in terms of wavelength in micron μ or commonly in terms of wavenumber $\bar{\nu}$ (cm^{-1}), since it is directly proportional to energy. The ordinary infrared region 2.5-15 μ ($4000\text{-}667\text{ cm}^{-1}$) is of greatest practical use to organic chemists. The region 0.8-2.5 μ ($12,500\text{-}4000\text{ cm}^{-1}$) is called the near infrared and the region 15-200 μ ($667\text{-}50\text{ cm}^{-1}$) the far infrared. Note that wavenumbers are often called frequencies, although strictly it is incorrect. However, it is not a serious error as long as we keep in mind that $\bar{\nu} = \frac{1}{\lambda}$ and $\nu = \frac{c}{\lambda}$. The absorption of infrared radiation by a molecule occurs

due to quantized vibrational and rotational energy changes when it is subjected to infrared irradiation. Thus, IR spectra are often called *vibrational-rotational spectra*. Unlike UV spectra, IR spectra have a large number of absorption bands and therefore provide plenty of structural information about a molecule. Bands observed in an IR spectrum correspond to various functional groups and bonds present in the molecule. Thus, IR spectroscopy is most widely used for the detection of functional groups and identification of organic compounds.

Instrumentation

Most IR spectrophotometers are double-beam instruments consisting of the following parts:

1. Radiation source
2. Sample and reference cells

3. Attenuator and comb (photometer)
4. Monochromator
5. Detector and amplifier
6. Recorder

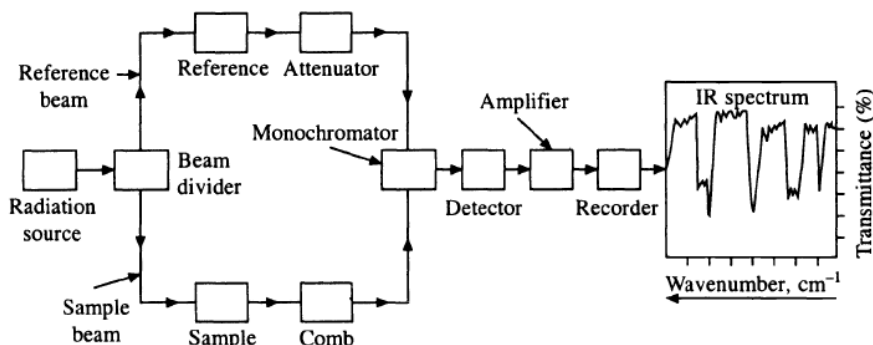

Block diagram of IR-spectroscopy

1. Radiation Source

Infrared radiation is usually produced by electrically heating a Nernst filament (mainly composed of oxides of zirconium, thorium and cerium) or a globar (rod of silicon carbide) to 1000-1800°C. The infrared radiation of successively increasing wavelength is used. The radiation from the source is divided into sample and reference beams of equal intensity by beam divider.

2. Sample and Reference Cells

Reference and sample beams pass through the reference cell and sample cell respectively. Glass and quartz cannot be used as windows of cells and optical prisms, etc. because they absorb strongly in most of the IR region. Thus, alkali metal halides such as NaCl, NaBr, KCl and KBr are most commonly used as these are transparent to most of the IR region.

3. Attenuator and Comb (Photometer)

The reference beam passes through the attenuator and the sample beam through the comb. Then the two beams can be alternately reflected out of the optical system and to the entrance slit of the monochromator with the help of several mirrors. Thus, the photometer combines the reference and sample beams into a single beam of alternating segments. The comb allows balancing of the two beams.

4. Monochromator

The combined beam passes through the prism or grating of the monochromator which disperses the beam into various frequencies. Since the prism or grating rotates slowly, it sends individual

frequency bands to the detector, thus allowing a scan of frequency bands. Gratings that give better resolutions than prisms consist of a series of parallel and straight thin lines on a smooth reflecting surface; the spacing between lines is of the order of few angstrom (\AA) depending on the desired wavelength range.

5. Detector and Amplifier

The detector is a thermocouple which measures radiant energy by means of its heating effect that produces current. Due to difference in the intensity of the two beams falling on the detector, an alternating current starts flowing from the detector to the amplifier where it is amplified and relayed to the recorder.

6. Recorder

It records IR spectra as a plot of wavelengths λ or wave numbers ν of absorbed radiations against the intensity of absorption in terms of transmittance T or absorbance A . Presently we use the wavenumber unit as it is directly proportional to energy

$$T = \frac{I}{I_o}$$

$$T\%(\text{percentage transmittance}) = \frac{I}{I_o} \times 100$$

$$A = \log_{10} \frac{1}{T}$$

where I_o is the intensity of the incident radiation and I the intensity of the radiation emerging from the sample.

At present, FT-IR (Fourier transform infrared) spectrophotometers have become common. The FT-IR instrument gives same information as a simple IR spectrophotometer but the former is much efficient, as it is quick, has high sensitivity and requires very small quantity of the sample.

Sample Handling

Infrared spectra of compounds may be recorded in the vapour phase, as pure liquids, in solution and in the solid state. The sample should be dry because water absorbs near -3710 cm^{-1} and near -1630 cm^{-1} .

In Solid State

As a mull or paste: About 2-5 mg of a solid is finely ground in a agat mortar with one or two drops of the mulling agent. The mull is examined as a thin film between two flat plates of NaCl. The most commonly used mulling agent is nujol (a high-boiling petroleum oil). When C-H bands

interfere with the spectrum, another mulling agent, hexachlorobutadiene, may be used.

As a Liquid Film

A drop of neat liquid is placed between two flat plates of NaCl to give a thin film. Thick samples of neat liquids usually absorb too strongly to give satisfactory spectrum. This is the simplest of all sampling techniques.

In Vapour Phase

The vapour or gas is introduced into a special cell which is usually about 10 cm long and the walls of its both the ends are normally made of NaCl which is transparent to IR radiation. The vapour phase technique is limited because of the too low vapour pressure of most organic compounds to produce a useful absorption spectrum.

In solution

Usually, a 1-5% solution of the compound is introduced into a special cell of 0.1-1 mm thickness and made of NaCl.

Origin of Infrared Spectra

IR absorption spectra originate from transitions in vibrational and rotational energy levels within a molecule. On absorption of IR radiation, vibrational and rotational energies of the molecule are increased. When a molecule absorbs IR radiation below 100 cm^{-1} , the absorbed radiation causes transitions in its rotational energy levels. Since these energy levels are quantized, a molecular rotational spectrum consists of discrete lines.

When a molecule absorbs IR radiation in the range $100\text{-}10,000\text{ cm}^{-1}$, the absorbed radiation causes transitions in its vibrational energy levels. These energy levels are also quantized, but vibrational spectra appear as bands rather than discrete lines. Thus, a single transition in vibrational energy levels is accompanied by a large number of transitions in rotational energy levels and so the vibrational spectra appear as vibrational-rotational bands instead of discrete lines. Organic chemists are mainly concerned with these vibrational-rotational bands, especially with those occurring in the region $4000\text{-}667\text{ cm}^{-1}$.

Atoms in a molecule are not still but they vibrate. The two types (modes) of fundamental molecular vibrations known are: (a) stretching and (b) bending vibrations.

Stretching Vibrations

In stretching vibrations, the distance between two atoms increases or decreases, but the atoms remain in the same bond axis. Stretching vibrations are of two types:

(a) *Symmetrical stretching*. In this mode of vibration, the movement of atoms with respect to the

common (or central) atom is simultaneously in the same direction along the same bond axis



Symmetric stretching (ν_s) of CH_2

(b) *Asymmetrical Stretching*. In this vibration, one atom approaches the common atom while the other departs from it.



Asymmetric stretching (ν_{as}) of CH_2

Bending Vibrations (Deformations)

In such vibrations, the positions of the atoms change with respect to their original bond axes.

Bending vibrations are of four types:

(a) **Scissoring**. In this mode of vibration, the movement of atoms is in the opposite direction with change in their bond axes as well as in the bond angle they form with the central atom.

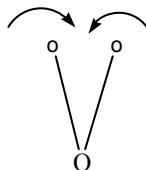

Scissoring of CH_2 in plane bending vibration

(b) **Rocking**: In this vibration, the movement of atoms takes place in the same direction with change in their bond axes. Scissoring and rocking are in-plane bendings.

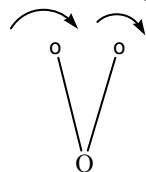

Rocking of CH_2 in plane bending vibration

Wagging: In this vibration, two atoms simultaneously move above and below the plane with respect to the common atom. Note: + and- signs indicate movements perpendicular to the plane of the paper.

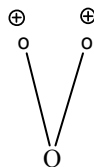

Wagging; Out-of-plane bending vibrations (CH_2)

(d) **Twisting:** In this mode of vibration, one of the atom moves up and the other moves down the plane with respect to the common atom.

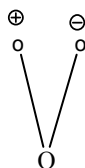

Twisting; Out-of-plane bending vibrations (CH_2)

Number of Fundamental Vibrations

The IR spectra of polyatomic molecules may exhibit more than one vibrational absorption bands. The number of these bands corresponds to the number of fundamental vibrations in the molecule which can be calculated from the degrees of freedom of the molecule. The degrees of freedom of a molecule are equal to the total degrees of freedom of its individual atoms. Each atom has three degrees of freedom corresponding to the three Cartesian Coordinates (x , y and z) necessary to describe its position relative to other atoms in the molecule. Therefore, a molecule having n atoms will have $3n$ degrees of freedom.

In case of a nonlinear molecule, three of the degrees of freedom describe rotation and three describe translation. Thus, the remaining $(3n - 3 - 3) = 3n - 6$ degrees of freedom are its vibrational degrees of freedom or fundamental vibrations, because

Total degrees of freedom ($3n$) = Translational + Rotational + Vibrational degrees of freedom

In case of a linear molecule, only two degrees of freedom describe rotation because rotation about its axis of linearity does not change the positions of the atom and three describe translation. Thus, the remaining $(3n - 2 - 3) = 3n - 5$ degrees of freedom are vibrational degrees of freedom or fundamental vibrations.

In carbon dioxide (CO₂) molecule

The number of vibrational degrees of freedom for the linear carbon dioxide (CO₂) molecule can be calculated as follows:

Number of atoms (n) = 3

Total degrees of freedom (3n) = 3 x 3 = 9

Rotational degrees of freedom = 2

Translational degrees of freedom = 3

Therefore, vibrational degrees of freedom = 9 - 2 - 3 = 4

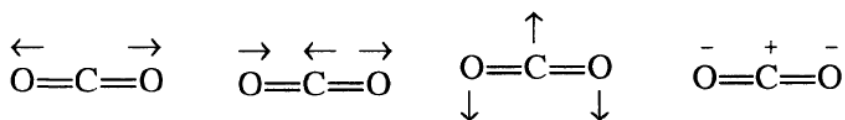

Vibration	v ₁	v ₂	v ₃	v ₄
Mode of Symmetrical vibration	stretching	Asymmetrical Stretching	In-plane bending	Out-of-plane bending
Infrared	Inactive	Active	Active	Active
Raman	Active	Inactive	Inactive	Inactive

The symmetrical stretching vibration v₁ produces no change in the dipole moment of the molecule, hence it is IR inactive. On the other hand, it produces change in polarizability, hence it is Raman active. The bending vibrations v₂ occur at the same frequency and are equivalent (degenerate) and produce change in dipole moment, hence are IR active. Similarly, the asymmetrical vibrations do not produce change in polarizability, hence are Raman inactive. Thus, the CO₂ molecule shows three fundamental bands, two in the IR spectrum and one in the Raman spectrum.

The carbon dioxide molecule is linear and has four fundamental vibrations (3 x 3) - 5 = 4. Thus, four theoretical fundamental bands are expected but actually it shows only two. The symmetrical stretching vibration in carbon dioxide is IR inactive because it produces no change in the dipole moment of the molecule. The two bending vibrations are equivalent and absorb at the same wavenumber (667.3 cm⁻¹). Thus, the IR spectrum of carbon dioxide shows only two fundamental absorption bands, one at 2350 cm⁻¹ due to asymmetrical stretching vibration, and the other at 667.3 cm⁻¹ due to the two bending vibrations.

Ethane (C₂H₆) molecule

Non-linear molecule ethane (C₂H₆), the vibrational degrees of freedom can be calculated as:

Number of atoms (n) = 8

Total degrees of freedom (3n) = 3 x 8 = 24

Rotational degrees of freedom = 3

Translational degrees of freedom = 3

Hence, vibrational degrees of freedom = $24 - 3 - 3 = 18$

Benzene (C₆H₆) molecule

Benzene (C₆H₆), the number of vibrational degrees of freedom can be calculated as follows:

Number of atoms (n) = 12

Total degrees of freedom (3n) = $3 \times 12 = 36$

Rotational degrees of freedom = 3

Translational degrees of freedom = 3

Therefore, vibrational degrees of freedom = $36 - 3 - 3 = 30$

Thus, theoretically, there should be 30 fundamental vibrational bands in the IR spectrum of benzene.

Fingerprint Region

It is not possible for any two different compounds to have exactly the same IR spectrum (except enantiomers). Therefore, the IR spectrum of a compound is called its *fingerprint*. The region below 1500 cm^{-1} is called fingerprint region because every compound has unique absorption pattern in this region, just as every person has unique fingerprints. The fingerprint region contains many absorption bands caused by bending vibrations as well as absorption bands caused by C-C, C-O like in alcohols, ethers, esters, etc. and C-N (e.g. in amines, amino acids, amides, etc.) Stretching vibrations.

Since the number of bending vibrations in a molecule is much greater than its Stretching vibrations, the fingerprint region is rich in absorption bands and shoulders. Thus, the superimposability of IR bands of the spectra of any two different compounds becomes impossible in this region. However, similar compounds may show very similar spectra above 1500 cm^{-1} .

Applications of IR Spectroscopy

Among all the properties of an organic compound, no single property gives as much information about the compound's structure as its infrared spectrum. Thus, IR spectroscopy is the most widely used method for structure determination of organic compounds. The basic reason why IR spectra are of such value to the organic chemists is that molecular vibrations depend on interatomic distances, bond angles and bond strengths, rather than on bulk properties of the compound.

Thus, these vibrational frequencies provide a molecular fingerprint which enables the identification of the compound either in the pure state or in mixtures. IR spectroscopy is

especially used for detection of functional groups in organic compounds and for establishing the identity of organic compounds.

Use of IR spectroscopy to organic chemistry as follows:

1. Detection of Functional groups

All functional groups absorb in a definite frequency region. Thus, the presence or absence of a band in a definite frequency region tells the presence or absence of a particular functional group in the compound.

For example, the presence of a ν C=O band in the region 1720-1740 cm^{-1} along with another band (usually two bands) in the region 2700-2900 cm^{-1} shows the presence of an aldehydic carbonyl group in the compound.

2. Purity of Samples

IR spectra of impure sample are usually blurred and have many bands which cannot be interpreted, whereas a pure compound gives a clear IR spectrum. For example, a sample of an alcohol containing a ketone as an impurity gives poor IR spectrum which shows additional absorption bands due to the carbonyl group.

3. Study of Hydrogen Bonding

IR spectroscopy is useful in detecting hydrogen bonding, in estimating the strength of hydrogen bonds and in distinguishing intermolecular and intramolecular hydrogen bondings.

4. Orientations in Aromatic Compounds

Absorptions in the region 675-900 cm^{-1} due to out-of-plane bending vibrations indicate the relative positions of substituents on the benzene ring. The position of absorption bands in this region depends on the number of adjacent hydrogen atoms on the ring.

5. Progress of Reactions

In most of the cases the progress of an organic reaction can be followed by IR spectroscopy. This is done by examining the IR spectra of portions of the reaction mixture withdrawn at certain time intervals. For example, in a reaction involving the oxidation of a secondary alcohol into a ketone, it is expected that the ν O-H band near 3570 cm^{-1} will disappear and a new ν C=O band will appear near 1715 cm^{-1} on completion of the reaction.

Interpretation of Infrared Spectra

There are no set rules for interpreting IR spectra. Organic chemists generally interpret IR spectra by inspecting and comparing the position, intensity and shape of bands with reference data available in tables of characteristic group frequencies. The presence or absence of an absorption band indicates the presence or absence of a particular functional group in a

compound. For example, appearance of an absorption band near 3330 cm^{-1} is indicative of an inter molecularly hydrogen bonded O-H group, similarly appearance of a band around 1700 cm^{-1} indicates the presence of a C=O group. After tentative assignment of an absorption band to a particular group, it should be confirmed wherever possible by examination of other band(s) expected for that group. For example, the assignment of a carbonyl band to an aldehyde should be confirmed by the appearance of a band or a pair of bands in the region $2700\text{-}2900\text{ cm}^{-1}$ due to aldehydic $\nu_{\text{C-H}}$. Similarly, the assignment of a carbonyl band to an ester should be confirmed by the presence of a strong band due to $\nu_{\text{C=O}}$ in the region $1000\text{-}1300\text{ cm}^{-1}$, etc frequencies are given in list of table given below. Usually, characteristic absorption bands of functional groups are used for their detection. It is rarely possible to deduce complete structure of a compound from its IR spectrum alone. In structure determination, IR spectroscopy is supplemented by chemical evidence and UV, NMR and mass spectral data.

Some characteristic group frequencies along with effects of structural environments on them are discussed as follows:

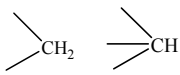
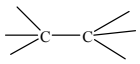
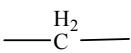
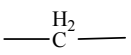
Type	Group	Absorption frequency (cm^{-1})	Intensity*	Assignment and remarks
Alkanes	—CH_3	2840-3000	m \rightarrow s	C-H stretch; two or three bands
				
		800-1200	w	C-C stretch; little value
Cycloalkanes		2840-3950	m	Asym. And Sym. C-H stretch, two bands
		(cyclopropane) 3040-3060	m	Asym. C-H stretch
		2975-2985	m	Sym. C-H stretch
		1015-1045	m	Skeletal vibration

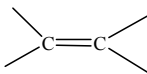
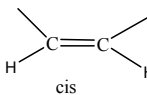
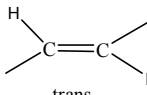
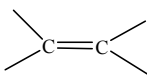
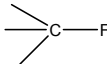
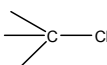
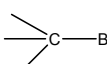
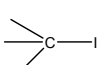
Alkenes		1620-1680	v	C=C stretch; diene,tiene.etc. 1650(s) and 1600(s)
	 cis	1655-1660	m	
	 trans	1670-1675	w	
		3000-3100	m	C-H stretch; almost the same position in the cis and trans isomer
Alkynes	$\text{—C}\equiv\text{C—}$	2100-2260	v	$\text{C}\equiv\text{C}$ stretch
	$\text{—C}\equiv\text{C—H}$	2100-2140	s	$\text{C}\equiv\text{C}$ stretch
Halogen Compounds	$\text{H}_3\text{C—X}$	near 3000	s	Asym. And sum. C-H
		1000-1400	s	C-F stretch
		600-800	s	C-Cl stretch
		500-750	s	C-Br stretch
		-500	s	C-I stretch
	$\text{H}_3\text{C—X}$	1441-3100	v	C-H Asym. bending
	X=F,Cl,Br,I	1255-1475	v	C-H Sym. bending

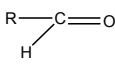
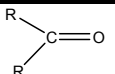
Aromatic	C-H	3000-3100	m	C-H stretch
	C-C	1600 ± 5	v	C=C skeletal stretch
		1580 ± 5	m	stretch; present when ring is further conjugated
Alcohols and Phenols	O-H	3590-3650	v	Free O-H stretch
		3200-3600	v	Intermediate hydrogen bonded O-H stretch
		2500-3200	s	Intermediate hydrogen bonded O-H stretch
	C-O	1000-1200	m → s	C-O stretch
		-1050	s	C-O stretch pri. alcohol
		-1100	s	C-O stretch sec. alcohol
		-1150	s	C-O stretch Ter. Alcohol
		-1200	s	C-O stretch phenols
	O-H	1339-1420	s	In-plane O-H stretch
		650-769	s	Out-of-plane O-H bending
Aldehydes		1720-1740	s	C=O stretch; saturated, aliphatic
		1695-1715	s	C=O stretch; aromatic
		1680-1705	s	C=O stretch; α,β-unsaturated aliphatic
Ketones		1705-1725	s	C=O stretch; saturated, acyclic
		1680-1700	s	C=O stretch; aryl
		1660-1670	s	C=O stretch; diaryl
Carboxylic Acid	-COOH	1700-1725	s	C=O stretch; saturated aliphatic
		1690-1715	s	C=O stretch; α,β-unsaturated aliphatic
		1680-1700	s	C=O stretch; aryl
Carboxylate Ions	-COO ⁻	1550-1650	s	C=O asym. stretch
		1300-1400	s	C=O sym. Stretch
Esters	R-COOR'	1735-1750	s	C=O stretch; saturated acyclic
		1650	s	C=O stretch; β-ketoester enolic

Acid halides	-COCl	1790-1815	s	C=O stretch; fluorides higher, bromides and iodine respectively lower
--------------	-------	-----------	---	---

Acid

Anhydrides	-CO-O-CO-	1800-1850	s	C=O stretch; two bands
		1740-1780	s	

Amides	R-CONH ₂	~1690	s	Pri. amide, C=O stretch
	R-CONHR	1670-700	s	Sec. amide, C=O stretch
	R-CONR ₂	1630-1670	s	Ter. amide, C=O stretch

Nitro	R-NO ₂	1550-1570	s	Asym., N=O stretch
-------	-------------------	-----------	---	--------------------

Compounds	(aliphatic)	1370-1380	s	Sym., N=O stretch
-----------	-------------	-----------	---	-------------------

And

Nitriles	Ar-NO ₂	1500-1570	s	Asym., N=O stretch
	(aromatic)	1300-1370	s	ym., N=O stretch

Nitriles	R—C≡N	200-2260	v	C≡N stretch
----------	-------	----------	---	-------------

And

Related	R—N≡C	2070-2220	m	N≡C stretch
---------	-------	-----------	---	-------------

Compounds (isonitriles)

	R—S—C≡N	2140-2175	s	C≡N stretch
--	---------	-----------	---	-------------

(thiocyanates)

Sulphur	-SH	2550-2600	w	S-H stretch; less affected by H-bonding
---------	-----	-----------	---	---

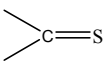
Compounds		1050-2100	s	C=S stretch
-----------	---	-----------	---	-------------

Phosphorus	P-H	2350-2440	s	P-H stretch
------------	-----	-----------	---	-------------

Compounds	P-O-R	1030-1240	s	P-O-C stretch
-----------	-------	-----------	---	---------------

Interpretation of IR-spectra of 2-pentanone

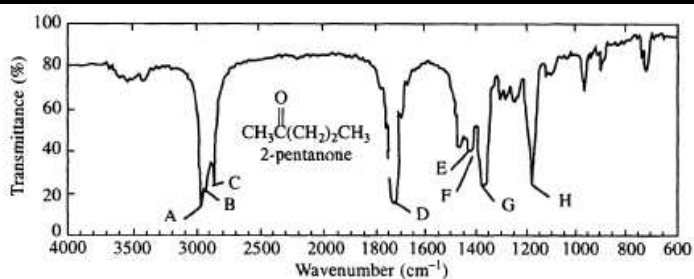

- A: ν_{as} , methyl, 2955 cm^{-1} E: δ_{as} , CH_3 , -1430 cm^{-1}
 B: ν_{os} , methylene, 2930 cm^{-1} F: δ_s , CH_2 , -1430 cm^{-1}
 C: ν_s , methyl, 2866 cm^{-1} G: δ_s , CH_3 of CH_3CO unit, -1370 cm^{-1}
 D: Normal C=O Stretching, 1725 cm^{-1} H: C-CO-C Stretching and bending, 1172 cm^{-1}

Interpretation of Organic compound ethyl acetate

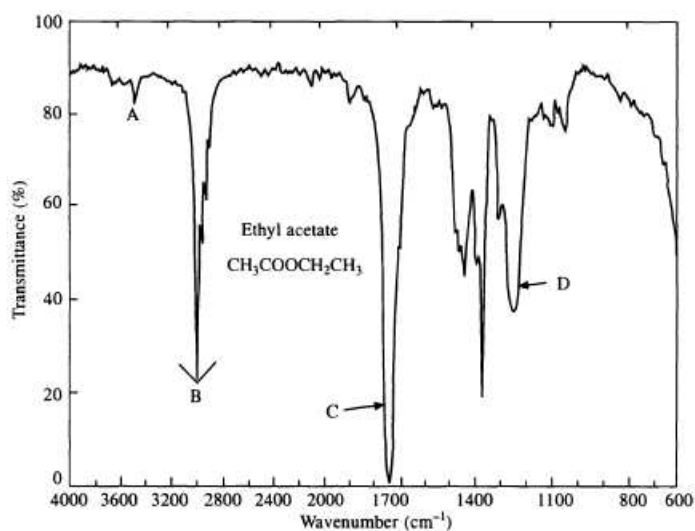

- A: Overtone band of C=O Stretching, frequency twice that of C=O stretching, 3478 cm^{-1}
 B: Methyl and methylene stretching bands, around 2900 cm^{-1}
 C: Normal ester C=O Stretching, 1740 cm^{-1}
 D: C-O-C Stretching, 1259 cm^{-1}

1.9 Summary

After study of this unit learner is able to define Electromagnetic Radiations, Electromagnetic spectrum and absorption of radiations, Absorption Laws, concepts of UV-Visible spectroscopy, Formation of Absorption Bands, Concepts of Chromatophore, Calculation of Absorption Maximum of organic compounds and theory and application of IR Spectroscopy for organic compounds to identification of compounds.

1.13 Terminal Questions

- 1 What is electronic spectroscopy? Discuss various types of electronic transitions giving at least one example.
- 2 Discuss the origin of UV-visible spectra.
- 3 How will you distinguish between the following pairs of compounds by UV spectroscopy:
 - (a) 1,3-pentadiene and 1,4-pentadiene
 - (b) Benzene and anthracene
 - (c) 1,3-hexadiene and 1,3-cyclohexadiene
- 4 Discuss the structural features which may cause a bathochromic or a hypsochromic effect in an organic compound.
- 5 Write notes on: (a) Stretching and bending vibrations (b) Fingerprint region
- 6 Discuss the factors which affect the IR absorption frequency of a functional group.
- 7 IR spectrum of a neat liquid with molecular formula C_2H_6O . Assign its structure.

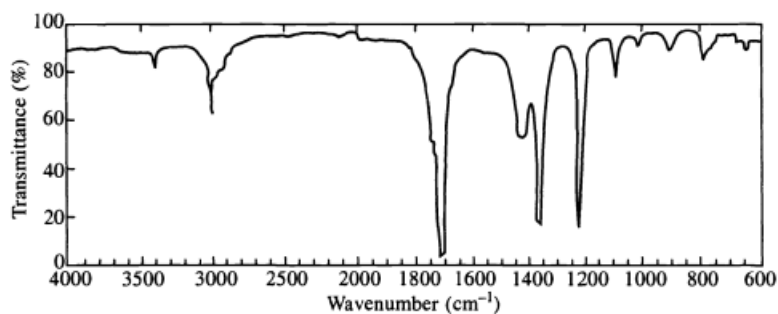

- 8** Using IR spectroscopy, how will you distinguish:
- (a) Intermolecular and intramolecular hydrogen bonding
 - (b) cis-cinnamic acid and trans-cinnamic acid
 - (c) Axial and equatorial O-H group.

Suggested readings:

1. Fayer, M. D., Ultrafast Infrared and Raman Spectroscopy, Marcel Dekker Inc., Taylor & Francis Group
2. Yadav, L.D.S., Organic Spectroscopy, Springer-Science+Business Media, Kluwer Academic Publishers
3. Tolstoy, Valeri P., Chernyshova, Irina V., Skryshevsky, Valeri A., Handbook of Infrared Spectroscopy of Ultrathin Films, A JOHN WILEY & SONS, INC., PUBLICATION
4. David Harvey, Modern Analytical Chemistry, McGraw-Hill Higher Education
5. Y R Sharma Elementary Organic Spectroscopy,
6. J. Michael Hollas, Modern Spectroscopy, John Wiley & Sons, Inc.
7. B.M. Trost, Problems in Spectroscopy: Organic Structure Determination by NMR, UV and Visible and Mass Spectra, Benjamin, 1967.
8. C.N.R. Rao, Ultraviolet and Visible Spectroscopy, 2nd Edition, Plenum, New York, 1967.
5. E.S. Stern and T.C.J. Timmons, Electronic Absorption Spectroscopy in Organic Chemistry, St. Martin's Press, New York, 1971.
9. F. Schienmann, Ed., An Introduction to Spectroscopic Methods for the Identification of Organic Compounds, Vol. 1, Pergamon Press, Oxford, 1970.

Unit 2: Alcohols and Phenols

2.0 Introduction

Objective

2.1 Classification and nomenclature of Alcohols

2.1.1 Hydrogen bonding, Acidic nature and Reactions of alcohols

2.1.2 Methods of formation by reduction of aldehydes, Ketones and Carboxylic Esters

2.1.3 Dihydric alcohols – nomenclature, methods of formation, chemical reactions of vicinal glycols

2.1.4 Oxidative cleavage [$\text{Pb}(\text{OAc})_4$ and HIO_4] and pinacolo-pinacolone rearrangement.

2.1.5 Trihydric alcohols – nomenclature and methods of formation, chemical reactions of glycerol.

2.2 Nomenclature, structure and bonding of Phenols

2.2.1 Physical properties and acidic character.

2.2.2 Preparation of phenols

2.2.3 Reactions of phenols – electrophilic aromatic substitution, acylation and carboxylation.

2.2.4 Mechanisms of Fries rearrangement, Claisen rearrangement, Gatterman synthesis, Hauben-Hoesch reaction, Lederer-Manasse reaction and Reimer- Tiemann reaction

2.3 Summary

2.4 Terminal Questions

2.5 Suggested Readings

2.0 Introduction

The alcohols and phenols are the family of organic compounds that contain the OH group with hydrocarbon chain. Were as in alcohols non-aromatic hydrocarbon chain contain the OH group and in phenols aromatic hydrocarbon chain contain the OH group. Alcohols are the family of compounds that contain one or more hydroxyl (-OH) groups attached to a single bonded alkane. Alcohols are represented by the general formula **-OH**. Alcohols are important in organic chemistry because they can be converted to and from many other types of compounds. Reactions with alcohols fall into two different categories. Reactions can cleave the R-O bond or they can cleave the O-H bond. Ethanol (ethyl alcohol, or grain alcohol) is found in alcoholic beverages, $\text{CH}_3\text{CH}_2\text{OH}$.

Objectives

After studying this unit learner is able:

- To give elucidation on alcohol and phenol
- Who to nomenclature, structure and bonding of alcohols and Phenols
- How prepare alcohols and phenols
- Explain physical properties and acidic character alcohols and phenols
- To explain mechanisms and rearrangement in reactions.
- Importance and application as well as their use in daily life

2.1 Classification and nomenclature of Alcohols

Alcohols are compounds of the general formula ROH, where R is any alkyl or substituted alkyl group. The group may be primary, secondary or tertiary, it may be open-chain or cyclic, it may contain a double bond, a halogen atom or an aromatic ring.

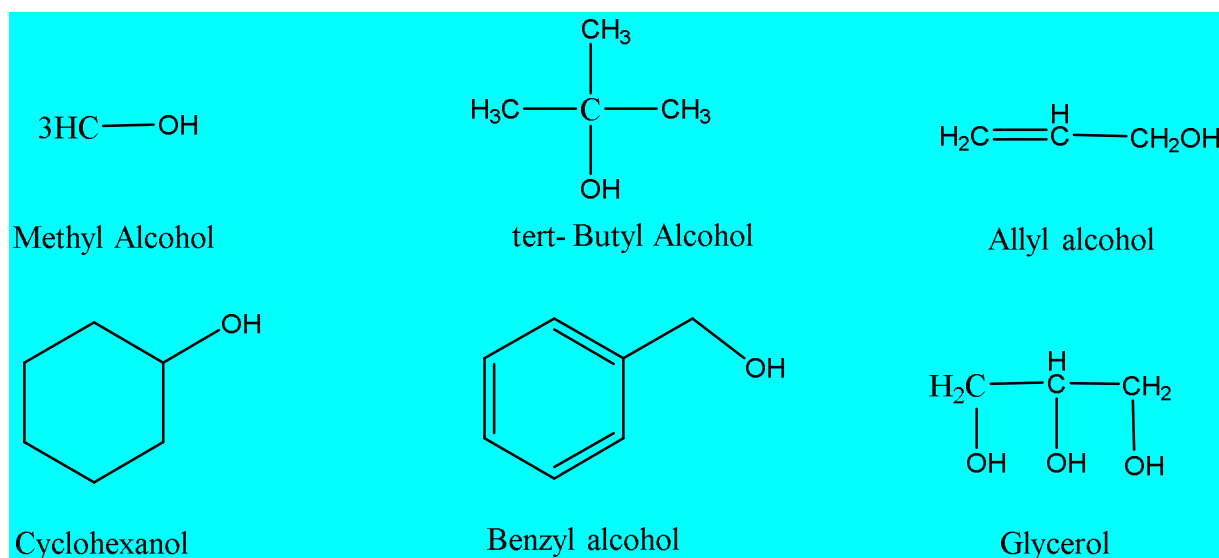

All alcohols- contain the hydroxyl -OH group, which, as the functional group, determines the properties characteristic of this family. Variations in structure of the R group may affect the rate at which the alcohol undergoes certain reactions, may affect the kind of reaction. Compounds in which the hydroxyl group is attached directly to an aromatic ring are not alcohols, they are phenols, differ so distinctly from the alcohols that we shall consider them in a separate section in this unit.

Classification of alcohols

Alcohol classification is an application of the neutral bonding patterns for organic compounds. Oxygen can only form two bonds. The alcohol functional group requires that one of these bonds form with hydrogen to create the hydroxyl group and the other bond needs to be with carbon to create an alcohol. All of the oxygen atoms of all the alcohols look the same, so a different distinction is needed. To classify alcohols, we look at the carbon atom bonded to the hydroxyl group. i.e. If hydroxyl group (-OH) attached to carbon, attached to 1 other carbon atoms group is called primary alcohols (1°), were as when if hydroxyl (-OH) attached to carbon group attached to 2 other carbon atom is called secondary alcohols (2°) and when if hydroxyl (-OH) attached to carbon attached to 3 other carbon atoms group is called tertiary alcohols (3°).

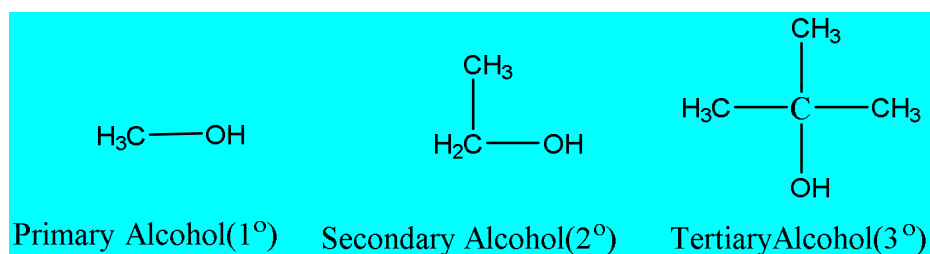

Alcohols of different classes differ only in rate or mechanism of reaction and in a way consistent with their structures. Certain substituents may affect reactivity in such a way as to make an alcohol of one class resemble the members of a different class.

Nomenclature

Alcohols are named by three different systems. For the simpler alcohols the common names, which are most often used. These consist simply of the name of the alkyl group followed by the word alcohol. For example: Ethyl alcohol, Isopropyl alcohol, Isobutyl alcohol, p-Nitrobenzyl alcohol, etc. where isopropyl alcohol is a secondary alcohol, whereas isobutyl alcohol is a primary alcohol.

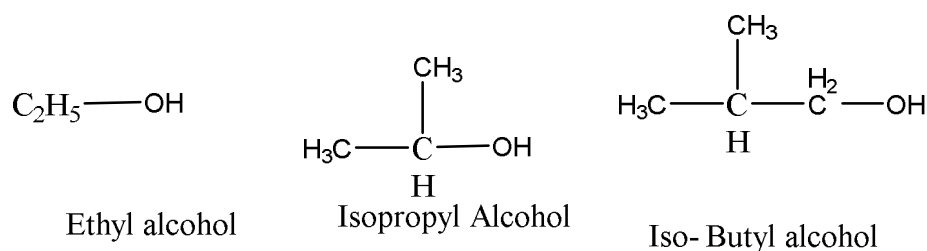

Finally, there is the most versatile system, the IUPAC rule.

The rules are:

1. Find the longest carbon chain containing at least one OH group, this is the parent if there are multiple OH groups, look for the chain with the most of them, and the way to count as many carbons in that chain name as an alcohol, alkane diol, triol, etc. number the OH groups, giving each group the lowest number possible when different numbering possibilities exist treat all other groups as lower priority substituents (alcohol / hydroxy groups are the highest priority group for naming) The parent structure is known as ethanol, propanol, butanol, etc., depending upon the number of carbon atoms; each name is derived by replacing the terminal -e of the corresponding alkane name by -ol.
2. Indicate by numbers the positions of other groups attached to the parent chain.

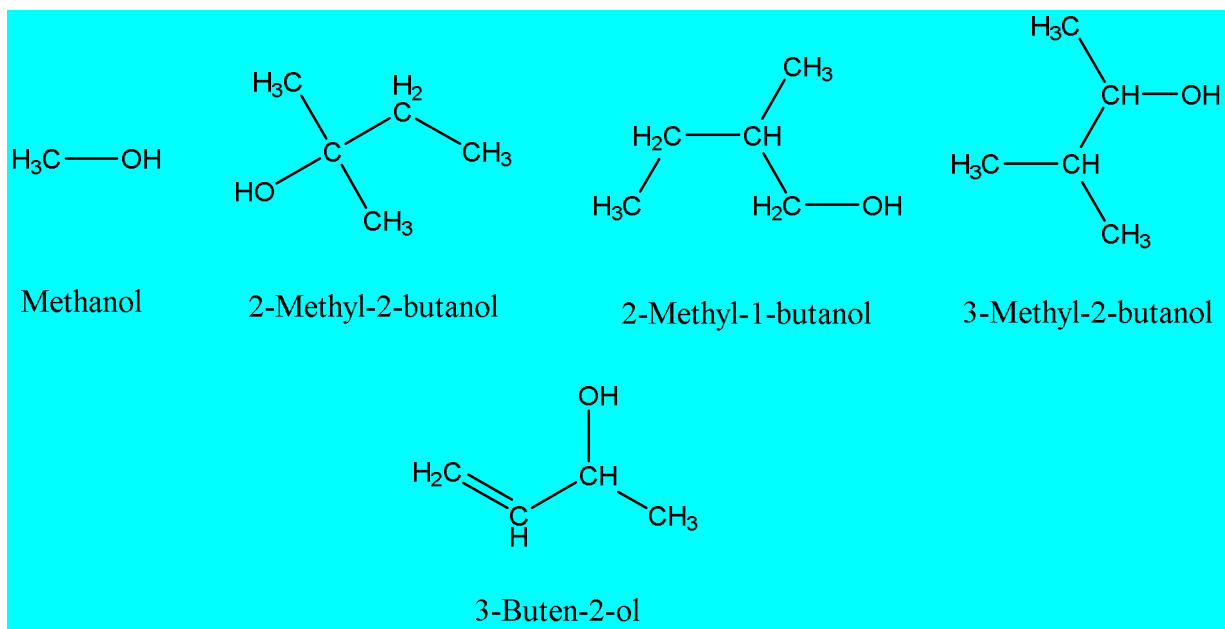

Self Assessment Questions

SAQ1. Define the various kinds of alcohols:

Primary alcohol, Secondary alcohol and Tertiary alcohol

SAQ2. Define difference between alcohol and Phenols?

SAQ3. Make structures of alcohol, alkane diol, triols.

2.1.1 Hydrogen bonding, Acidic nature and Reactions of alcohols

High polarity of the hydroxyl group which confers a measure of polar character to the molecule. As a result, there is a significant attraction of one molecule for another that is particularly pronounced in the solid and liquid states. This polar character leads to association of alcohol molecules through positive hydrogen of one hydroxyl group with correspondingly negative oxygen of another hydroxyl group.

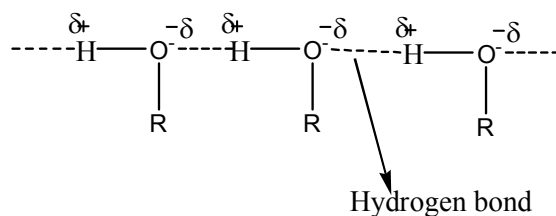

This type of association is called “hydrogen bonding” and the strengths of such bonds are much less than those of most conventional chemical bonds, they are still significant about 5 to 10 kcal per bond. Clearly then, the reason alcohols have higher boiling points than corresponding alkyl halides, ethers or hydrocarbons because, for the molecules to vaporize, additional energy is required to break the hydrogen bonds.

The water solubility of the lower molecular weighted alcohols is pronounced as readily as the result of hydrogen bonding with water molecules. Water and alcohols are associated as polymeric aggregates in liquid and solid states whereas carboxylic acids and amides exist as dimer in the liquid and gaseous phase due to **intermolecular hydrogen bonding**.

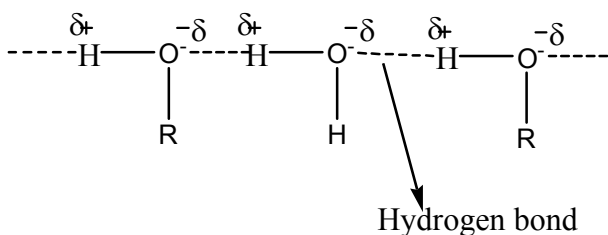

Intramolecular hydrogen bond is formed between two atoms within the same molecule. This results in the formation of five or six membered ring (chelate ring).

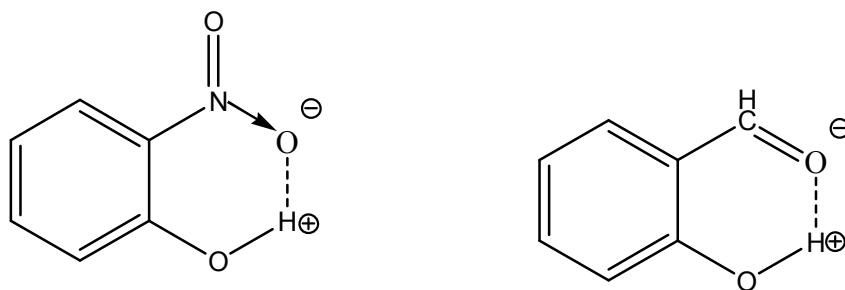

In methanol, the hydroxyl group accounts for almost half of the weight of the molecule and it is not surprising that the substance is completely soluble in water. As the size of the hydrocarbon groups of alcohols increases, the hydroxyl group accounts for progressively less of the molecular weight, hence water solubility decreases.

The boiling points of the following simple primary alcohols with up to 4 carbon atoms:



These boiling points are compared with those of the equivalent alkanes such as methane to butane with the same number of carbon atoms.

- The boiling point of an alcohol is always significantly higher than that of the analogous alkane.
- The boiling points of the alcohols increase as the number of carbon atoms increases.

The patterns in boiling point reflect the patterns in intermolecular attractions.

Self Assessment Questions

SAQ 4. Show Hydrogen bonding in alcohols and how it different from hydrogen bonding in water molecules.

SAQ 5. Impact of hydrogen bonding in alcohols

Acidic and Basic properties of alcohols

The order of acidity of various liquid alcohols generally is water > primary > secondary > tertiary ROH. By this we mean that the equilibrium position for the proton-transfer reaction lies more on the side of ROH and OH as R is changed from primary to secondary to tertiary; therefore, tert-butyl alcohol is considered less acidic than ethanol.

Sodium alkoxides are made by direct action of sodium metal on dry alcohols:

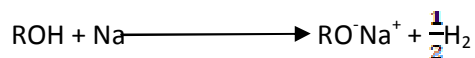

An alkoxide Sodium phenoxides, on the other hand, because of the appreciable acidity of phenols are made by the action of aqueous sodium hydroxide on phenols.



However, in the gas phase the order of acidity is reversed and the equilibrium position for lies increasingly on the side of R is changed from primary to secondary to tertiary, tert-butyl alcohol is therefore more acidic than ethanol in the gas phase.

Acidity of alcohol depends on the stability of alkoxide ion *i.e.*, conjugate base of alcohol which is obtained by the dissociation of alcohols.

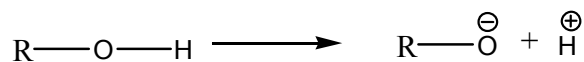

Alkoxide ion

Acid strength of Alcohol \propto Stability of Alkoxides ion

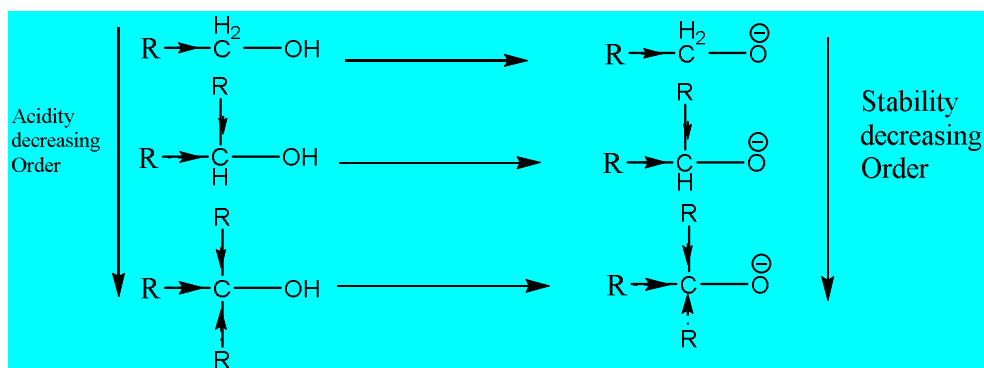

In solution, the larger anions of alcohols, known as alkoxide ions, probably are less well solvated than the smaller ions, because fewer solvent molecules can be accommodated around the negatively charged oxygen in the larger ions.

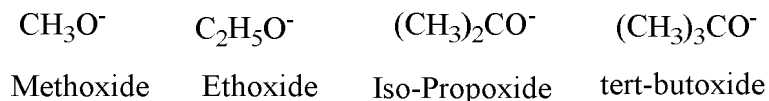

Alcohols involving the O-H bond of Compounds with Basic Properties

Alcohols are bases similar in strength to water and accept protons from strong acids. An example is the reaction of methanol with hydrogen bromide to give methyloxonium bromide, which is analogous to the formation of hydroxonium bromide with hydrogen bromide and water.

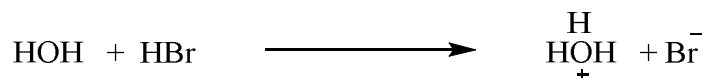
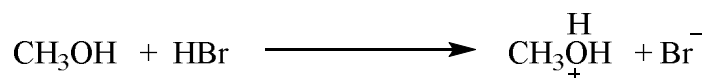

Dehydration of alcohols

An alcohol is converted into an alkene by dehydration, with elimination of a molecule of water. Dehydration requires the presence of an acid and heat. It is generally carried out in either of two ways:

- (a) Heating the alcohol with sulfuric or phosphoric acid to temperatures as high as 200°C.
- (b) Passing the alcohol vapor over alumina, Al_2O_3 , at 350-400°C, alumina here serving as a Lewis acid.

The various classes of alcohols differ widely in ease of dehydration,

The order of reactivity = **3° alcohols > 2° alcohols > 1° alcohols**

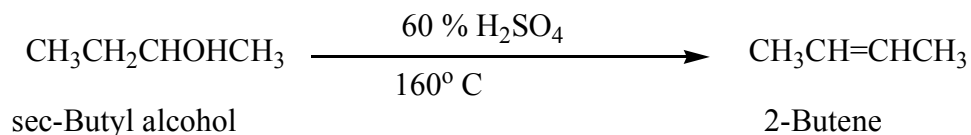
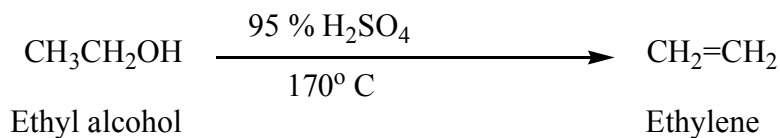

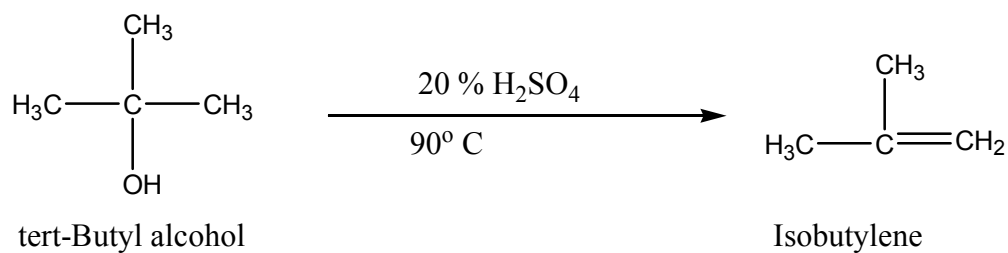

The generally accepted mechanism for the dehydration of alcohols is summarized in the following equations, ethyl alcohol is used as the example.

Step-1: The alcohol unites with a hydrogen ion to form the protonated alcohol,

Step-2: The protonated alcohol dissociates into water and a carbonium ion.

Step-3: The carbonium ion then loses a hydrogen ion to form the alkene.

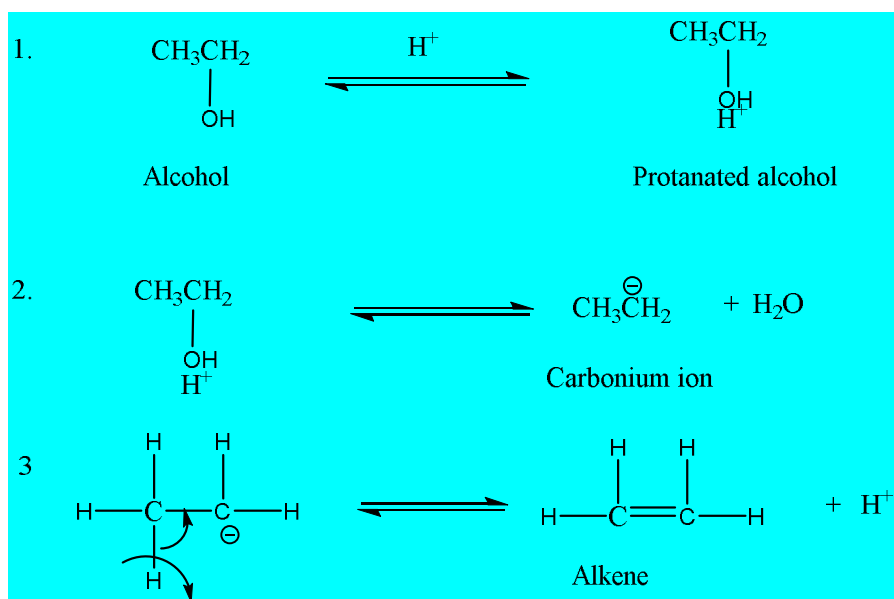

(1) Secondary and tertiary alcohols always give First Order Elimination (E_1) reaction. Primary alcohols whose α -carbon is 3° or 4° also give E_1 reaction.

(2) Primary alcohols whose β -carbon is 1° or 2° give Second Order Elimination (E_2) reaction.

(3) Dehydrating reagents for alcohols are:

conc. $\text{H}_2\text{SO}_4/\Delta$, KHSO_4/Δ , $\text{H}_3\text{PO}_4/\Delta$, anhy. $\text{Al}_2\text{O}_3/\Delta$, anhy. PCl_5/Δ , anhy. ZnCl_2/Δ , BF_3/Δ and $\text{P}_2\text{O}_5/\Delta$.

(4) Reactivity of alcohols for elimination reaction is as follows:



(5) Rearrangement occurs in E_1 as well as in E_2 reactions.

(6) Minor product, Major product On the basis of the mechanism; one can conclude that product formation takes place according to Saytzeff rule in E_1 as well as in E_2 reaction.

(7) Tertiary alcohols are so reactive that they undergo dehydration on strong heating even in the absence of dehydrating agent. In this process Cu works as catalyst.

(8) -I group present in an alcohol increases its reactivity for dehydration and Reactivity \propto -I power of the group present in the alcohol.

(b) Alcohols having -I group undergo dehydration in the presence of acids as well as bases.

Self Assessment Questions

SAQ6. Impact of alcohols with acids at high temperature?

SAQ7. Define acidic strength of 1° , 2° , and 3° alcohols.

Methods of formation of alcohols by Oxidation

All alkanes burn readily in excess of air or oxygen to form CO_2 , water and heat. The generation of heat in this process has been exploited by using them as a fuel in the internal combustion engines. On the other hand, if controlled oxidation under various conditions leads to different products. Alkanes, when burnt in the presence of catalyst at higher temperature and pressure, yield alcohol, aldehydes, ketones and acids.

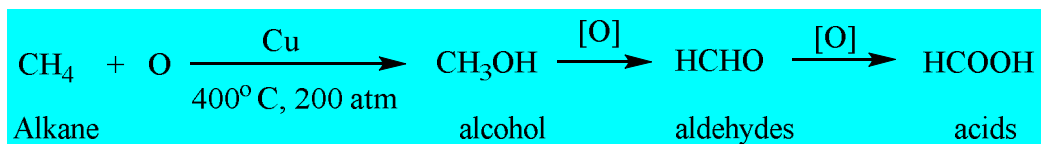

2.1.2 Methods of formation by reduction of aldehydes, Ketones and Carboxylic Esters

The most important method of preparing alcohols is the Grignard synthesis. The alkyl halides from which the Grignard reagents are made as well as the aldehydes and ketones themselves are most conveniently prepared from alcohols, thus the method ultimately involves the synthesis of alcohols from less complicated alcohols.

The Grignard reagent, we recall, has the formula RMgX , and is prepared by the reaction of metallic magnesium with the appropriate organic halide. This halide can be alkyl (1° , 2° , 3°), allylic, benzyl or aryl.

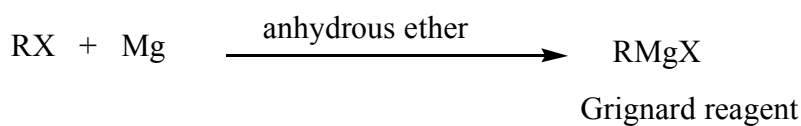

One of the most important uses of the Grignard reagent is its reaction with aldehydes and ketones to yield alcohols. The functional group of both is the carbonyl group, $\text{C}=\text{O}$,

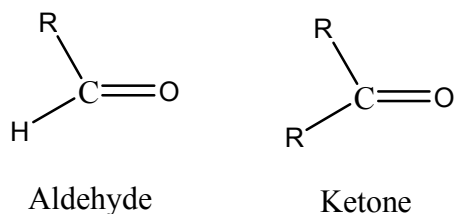

The carbon-magnesium bond of the Grignard reagent is a highly polar bond, carbon being negative relative to electropositive magnesium. Then, that in the addition to carbonyl compounds the organic group becomes attached to carbon and magnesium to oxygen. The product is the magnesium salt of the weakly acidic alcohol and is easily converted into the alcohol itself by the addition of the stronger acid, water.

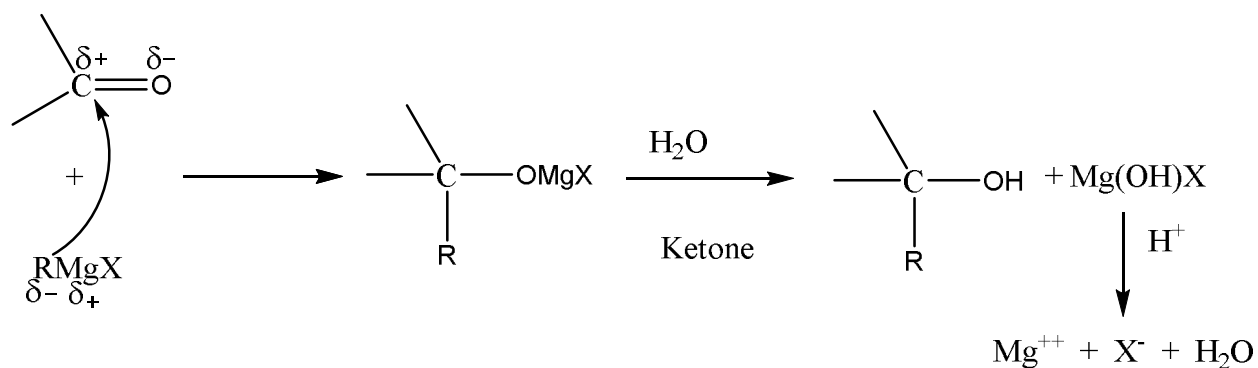

Since the Mg(OH)_x is formed is gelatinous material, dilute mineral acid i.e. HCl , H_2SO_4 is commonly used instead of water, so that water-soluble magnesium salts are formed.

The class of alcohol that is obtained from a Grignard synthesis depends upon the type of carbonyl compound used such as formaldehyde (HCHO), yields primary alcohols; other aldehydes (RCHO), yield secondary alcohols; and ketones (R_2CO), yield tertiary alcohols.

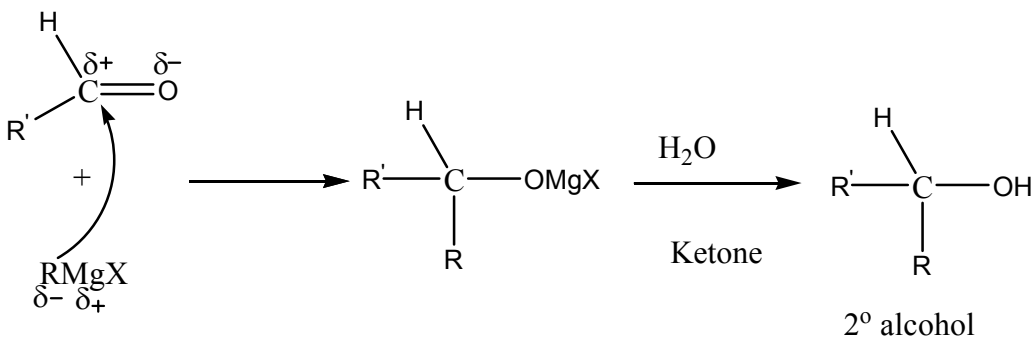
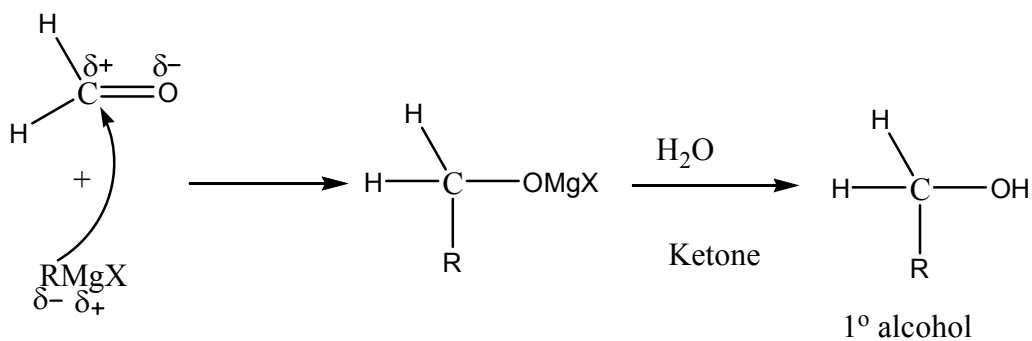

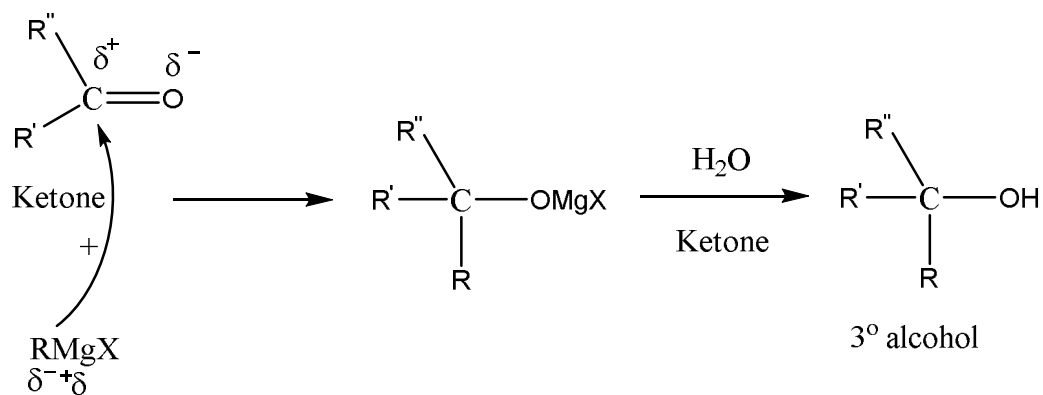

Self Assessment Questions

SAQ8. Define methods of formation of alcohols by oxidation and reductions?

SAQ9. How RMgX react with alcohols?

Formation of alcohols by reaction of carboxylic esters

The reaction of carboxylic esters with Grignard reagents is an excellent method for preparing tertiary alcohols. As in the reaction with aldehydes and ketones the nucleophilic (basic) alkyl or aryl group of the Grignard reagent attaches itself to the electron-deficient carbonyl carbon.

In the present case the products obtained correspond to the addition of the Grignard reagent to such a ketone. Two of the three groups attached to the carbon bearing the hydroxyl group in the alcohol come from the Grignard reagent and hence must be identical; places limits upon the alcohols that can be prepared by this method. Where, applicable reaction of a Grignard reagent with an ester is preferred to reaction with a ketone because esters are generally more accessible.

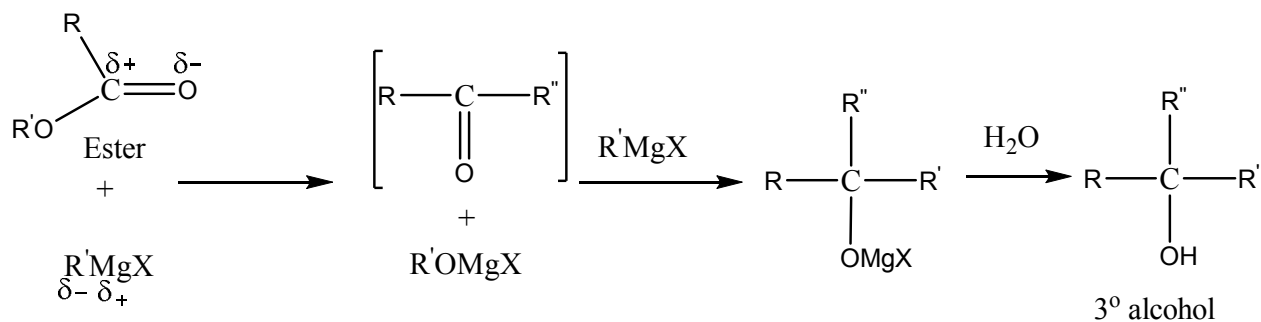

Esters can be reduced in two ways:

(a) By catalytic hydrogenation using molecular hydrogen or (b) By chemical reduction.

a. **Hydrogenolysis** (cleavage by hydrogen) of an ester requires more severe conditions than simple hydrogenation to (addition of hydrogen) a carbon-carbon double bond. High pressures and elevated temperatures are required, the catalyst used most often is a mixture of oxides known as copper chromite, of approximately the composition $\text{CuO} \cdot \text{CuCr}_2\text{O}_4$.

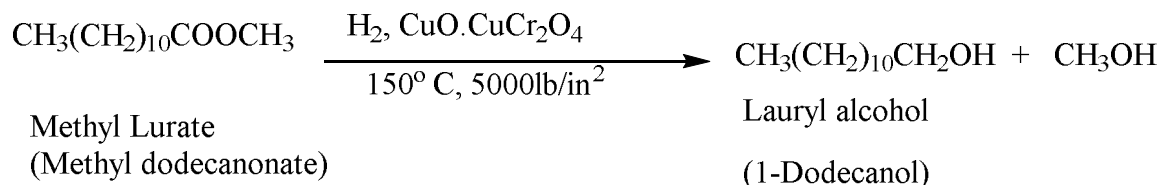

b. **Chemical reduction** is carried out by use of sodium metal and alcohol, or more usually by use of lithium aluminium hydride.

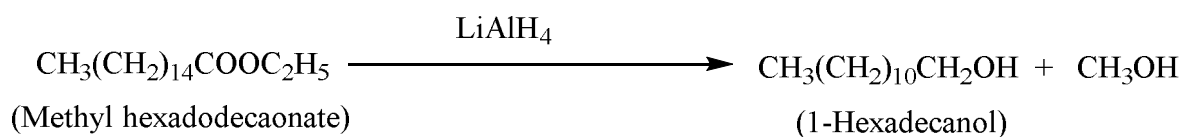

2.1.3 Dihydric alcohols – nomenclature, methods of formation, chemical reactions of vicinal

glycols

Alcohols containing two hydroxyl groups are called glycols. They have both common names and IUPAC names. Certain oxidizing agents convert alkenes into compounds known as glycols. Glycols are simply dihydroxy alcohols, their formation amounts to the addition of two hydroxyl groups to the double bond. The oxidizing agents that cause hydroxylation, two of the most commonly used are (a) cold alkaline KMnO_4 and (b) Peroxyformic acid, HCO_2OH .

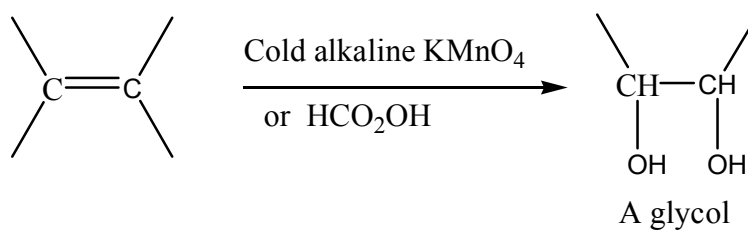

A glycol is frequently named by adding the word glycol to the name of the alkene from which it is formed. For example:

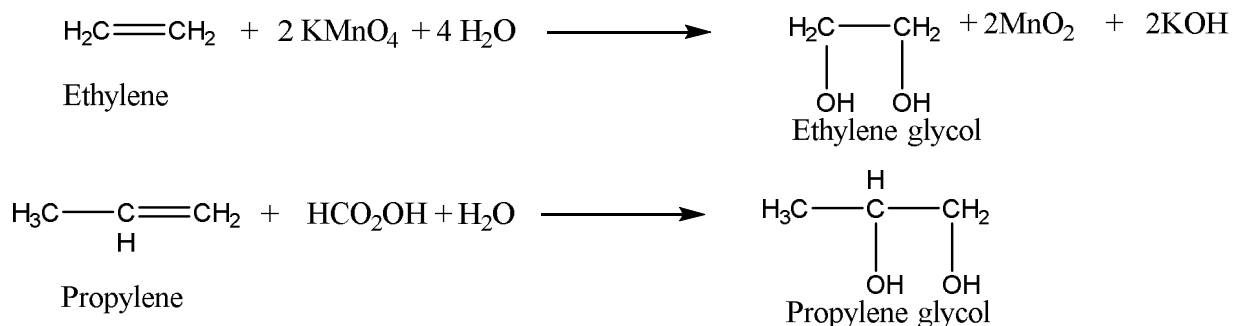

2.1.4 Oxidative cleavage [Pb(OAc)₄ and HIO₄] and pinacolo-pinacolone rearrangement.

Oxidative cleavage of glycol by [Pb(OAc)₄ and HIO₄]:

The vicinal glycols prepared by alkene hydroxylation are cleaved to aldehydes and ketone in high yield by the action of lead acetate [Pb(OAc)₄] or periodic acid [HIO₄] this oxidative cleavage of a carbon-carbon single bond provides a two step alternative to ozonolysis. A general equation for these is shown below. As rule cis-glycol react more readily than trans-glycols evidence shown by heterocyclic intermediates.

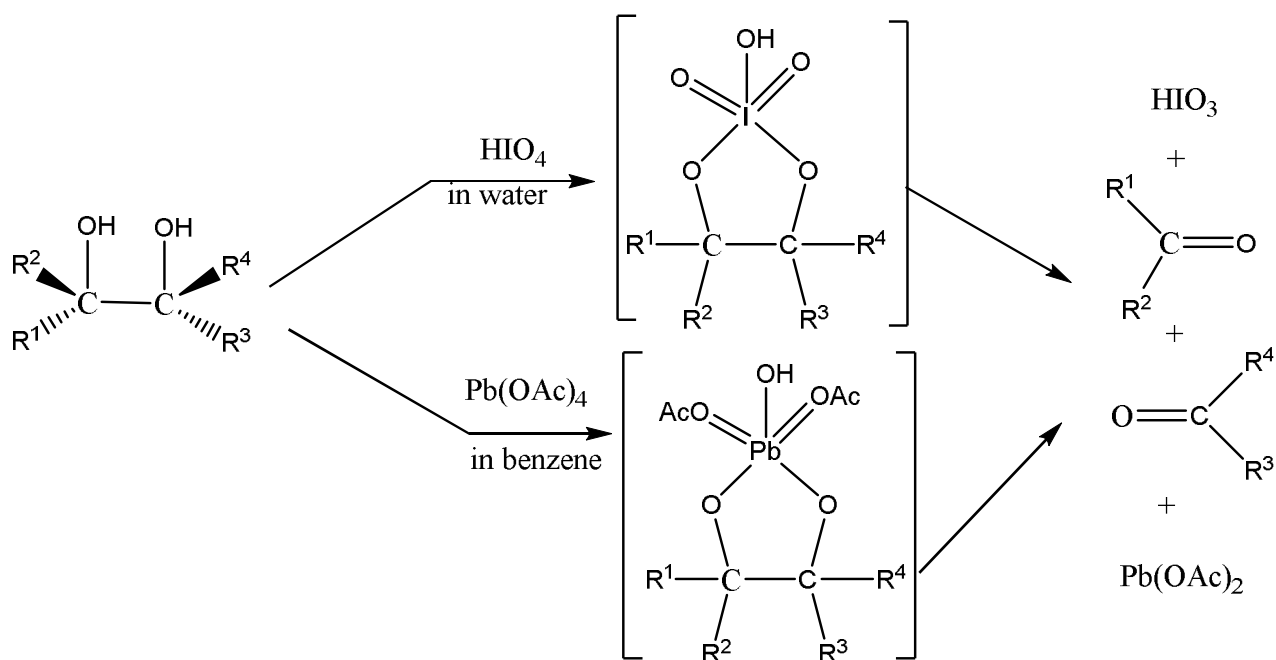

Analysis of glycols:

Upon treatment with periodic acid, HIO₄, compounds containing two or more OH or O groups attached to adjacent carbon atoms undergo oxidation with cleavage of carbon-carbon bonds.

The oxidation is particularly useful in determination of structure. Qualitatively, oxidation by HIO₄ is indicated by formation of a white precipitate (AgIO₃) upon addition of silver nitrate. Since the reaction is usually quantitative, valuable information is given by the nature and amounts of the products and by the quantity of periodic acid consumed.

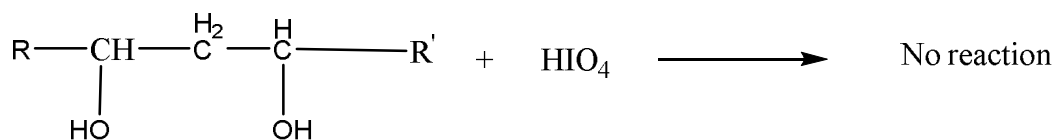
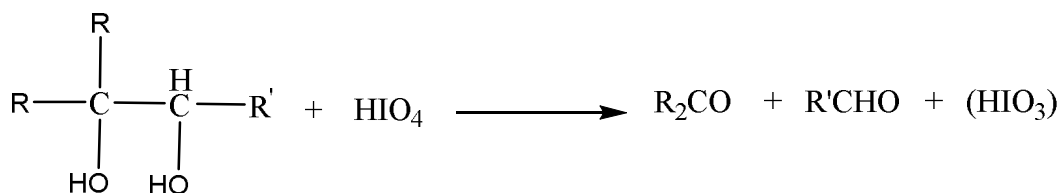
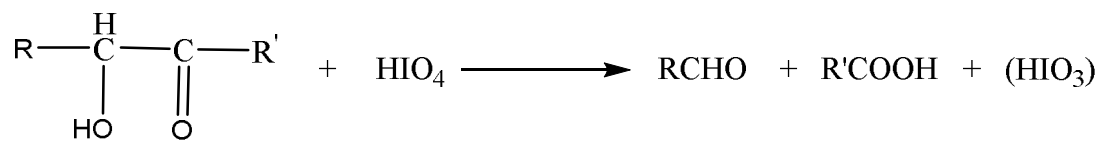
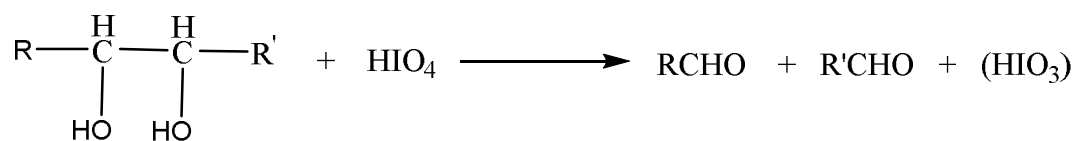

Pinacolo-pinacolone rearrangement

Migration to electron-deficient carbon, Upon treatment with mineral acids, 2,3-dimethyl-2,3-butanediol is often called pinacol and is converted into methyl tert-butyl ketone is often called pinacolone. The glycol undergoes dehydration in such a way that rearrangement of the carbon skeleton occurs. Other glycols undergo analogous reactions, which are known collectively as pinacol rearrangements.

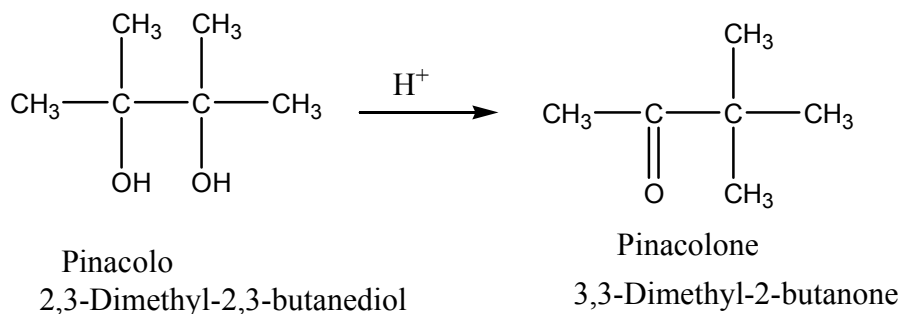

Self Assessment Questions

SAQ10. What are glycol how they different form alcohols?

SAQ11. Give Properties of Glycol and Pinacol-pinacolone rearrangements in glycol?

2.1.5 Trihydric alcohols – nomenclature and methods of formation, chemical reactions of glycerol.

Synthesis of glycerol or trihydric alcohols from Fat:

Fats are carboxylic esters derived from the single alcohol, glycerol, $\text{HOCH}_2\text{CHOHCH}_2\text{OH}$, and are known as glycerides. More specifically, they are triacylglycerols.

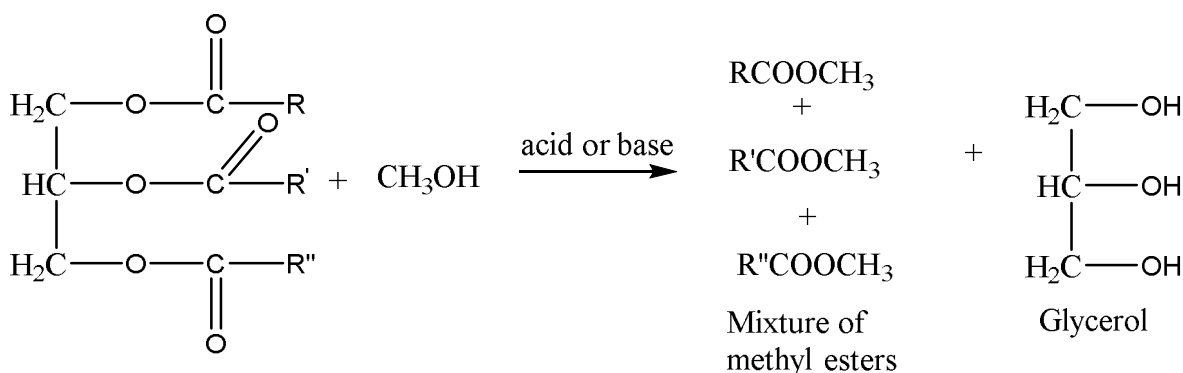

A fat (A glyceride)

Modern soap manufacturers use hydrolysis of glycerides. Hydrolysis yields salts of the carboxylic acids and glycerol, $\text{CH}_2\text{OHCHOHCH}_2\text{OH}$. Ordinary soap today is simply a mixture of sodium salts of long-chain fatty acids. It is a mixture because the fat from which it is made is a mixture, and for washing our hands or our clothes a mixture is just as good as a single pure salt. Soap may vary in composition and method of processing: if made from olive oil, it is Castile soap, alcohol can be added to make it transparent, air can be beaten in to make it float, perfumes, dyes and germicides can be added if a potassium salt (instead of a sodium salt, it is soft soap).

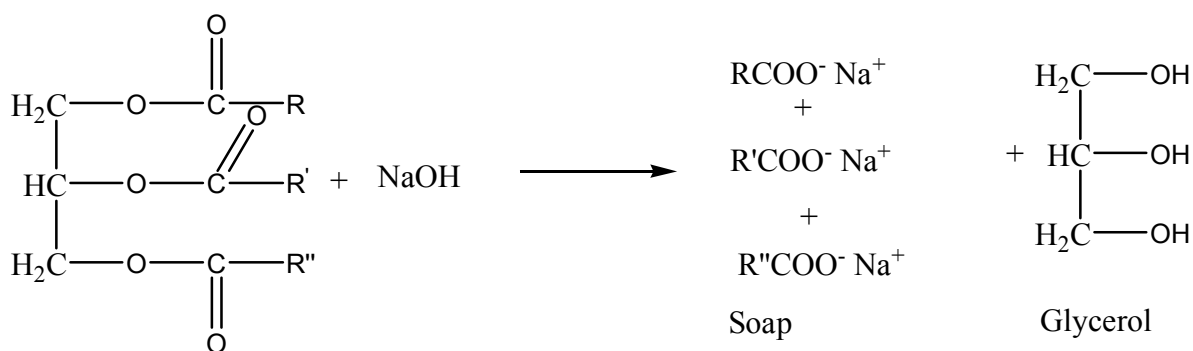

A fat (A glyceride)

Dehydration of glycerol by hot sulfuric acid to yield the unsaturated aldehyde acrolein

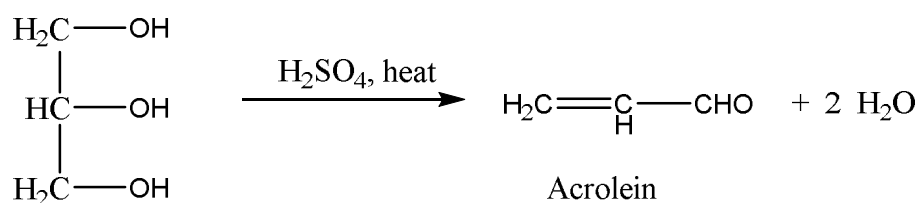

Glycerol

Quinoline itself is obtained from the reaction of aniline with glycerol, concentrated sulfuric acid, nitrobenzene and ferrous sulfate is the Skraup synthesis.

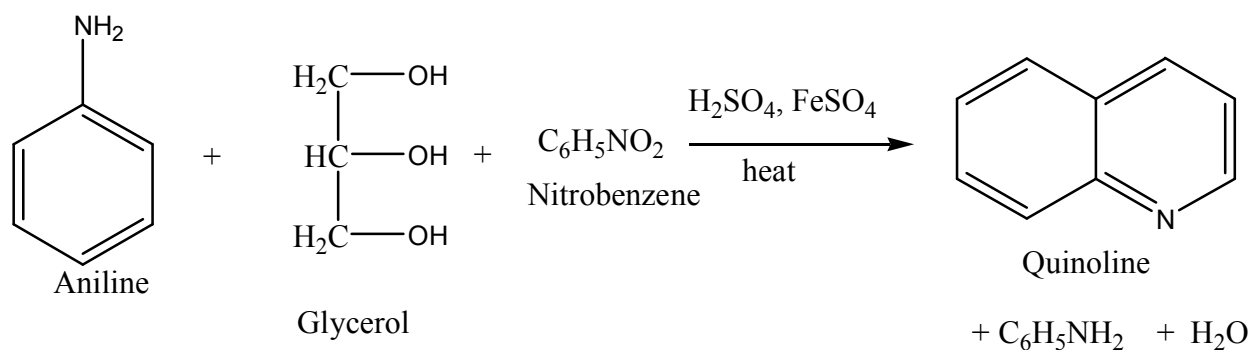

Self Assessment Questions

SAQ12. How Glycerol is different form Glycol and alcohol?

SAQ13. How Soap if prepared from Glycerol?

SAQ14. How Quinoline is prepared from Glycerol?

2.2 Nomenclature, structure and bonding of Phenols

Phenol is a constituent of coal tar and was probably first isolated from coal tar in 1834 by Runge, who called it 'carbolic acid' or 'coal oil acid'. Pure phenol was first prepared by Laurent in 1841. In 1843, Charles Frederic Gerhardt also prepared phenol by heating salicylic acid with lime and gave it the name 'phenol'. The Raschig–Dow process of manufacturing phenol by cumene was discovered by Wurtz and Kekule in 1867, although the earlier synthesis was recorded by Hunt in 1849.

Phenol was first used as a disinfectant in 1865 by the British surgeon Joseph Lister at Glasgow University, Scotland, for sterilizing wounds, surgical dressings and instruments. He showed that if phenol was used in operating theatres to sterilize equipment and dressings, there was less infection of wounds and, moreover, the patients stood a much better chance of survival. Phenol only has limited use in pharmaceuticals today because of its toxicity. Phenol occurs in normal metabolism and is harmless in small quantities according to present knowledge, but it is definitely toxic in high concentrations. It can be absorbed through the skin, by inhalation and by swallowing. Phenol is a violent systemic poison. Less irritating and more efficient germicides.

2.2.1 Physical properties and acidic character

Acidity of Phenol

Compounds like alcohols and phenol which contain an -OH group attached to a hydrocarbon are very weak acids. Alcohols are so weakly acidic for normal lab purposes, their acidity can be virtually ignored. However, phenol is sufficiently acidic for it to have noticeably acidic properties even if it is still a very weak acid. A hydrogen ion can break away from the -OH group and transfer to a base.

For example:

Solution in water

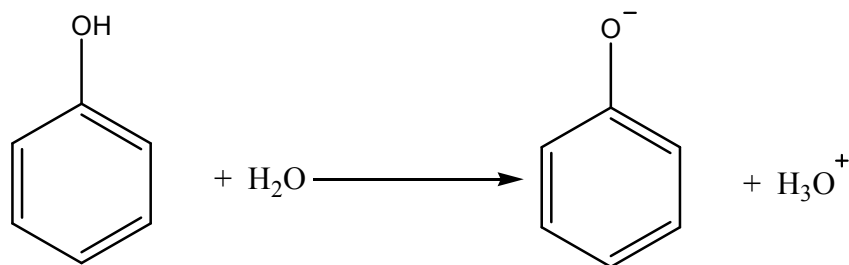

Phenol is a very weak acid and the position of equilibrium lies well to the left. Phenol can lose a hydrogen ion because the phenoxide ion formed is stabilised to some extent. The negative charge on the oxygen atom is delocalised around the ring. The more stable the ion is likely to form. One of the lone pairs on the oxygen atom overlaps with the delocalised electrons on the benzene ring. This overlap leads to a delocalization which extends from the ring out over the oxygen atom. As a result, the negative charge is no longer entirely localized on the oxygen but is spread out around the whole ion.

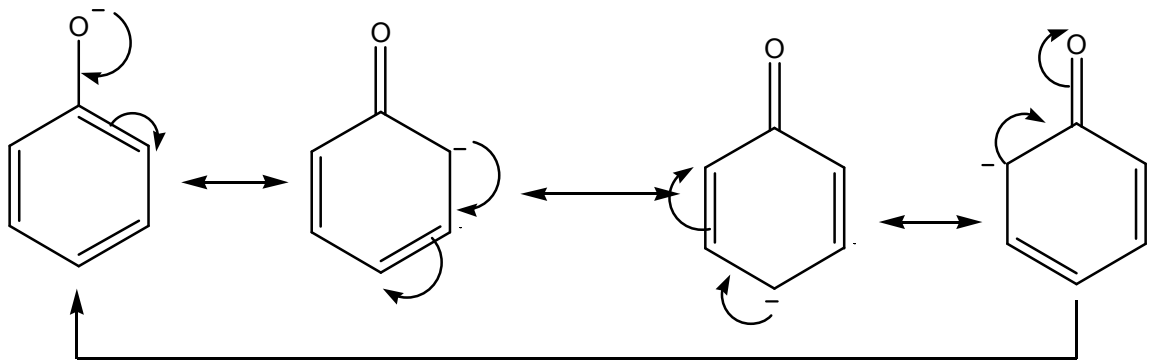

Spreading the charge around makes the ion more stable than it would be if all the charge remained on the oxygen. However, oxygen is the most electronegative element and the delocalized electrons will be drawn towards it. That means that there will still be a lot of charge around the oxygen which will tend to attract the hydrogen ion back again. That is why phenol is only a very weak acid.

Self Assessment Questions

SAQ15. Define acidity of phenols and alcohols?

SAQ16. Why Phenol is very weak acid with explanation?

2.2.2 Preparation of phenols

In the laboratory, phenols are generally prepared by one of the two methods

1. Hydrolysis of diazonium salts.
2. Oxidation of arylthallium compounds

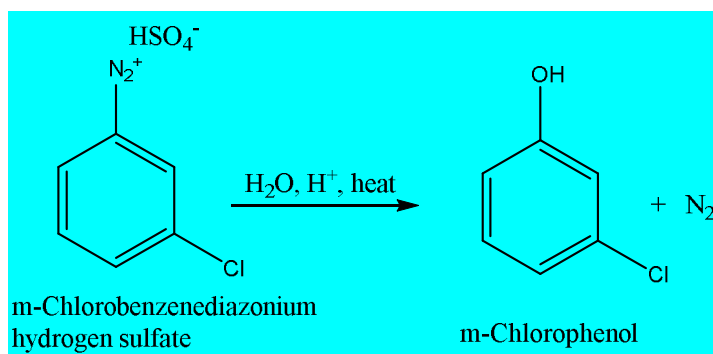
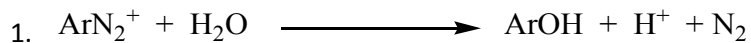

2.

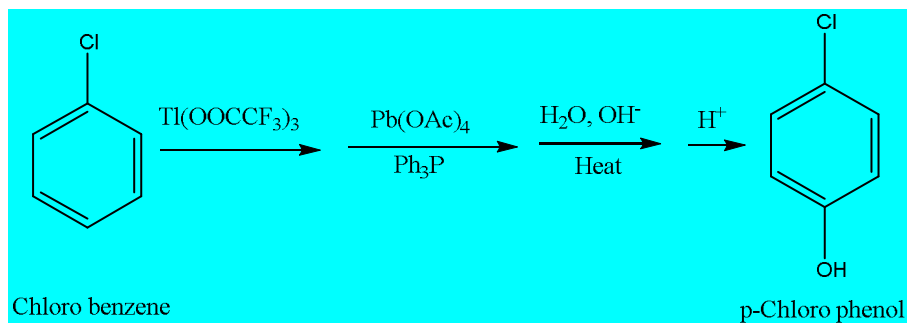
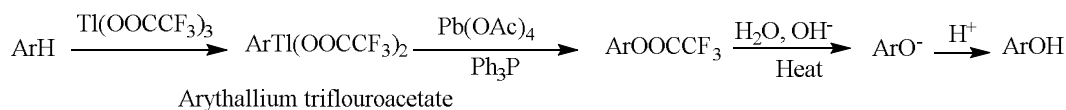

2.2.3 Reactions of phenols

Phenols undergo not only those electrophilic substitution reactions that are typical of most aromatic compounds but also many others that are possible only because of the unusual reactivity of the ring.

1. Acidity. Salt formation

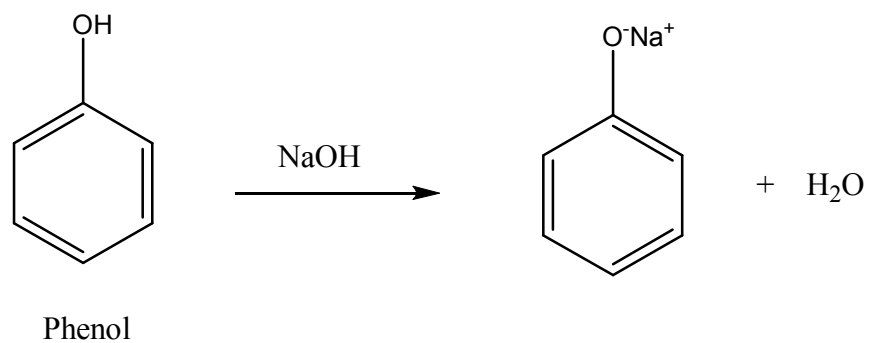

2. Ether formation. Williamson synthesis

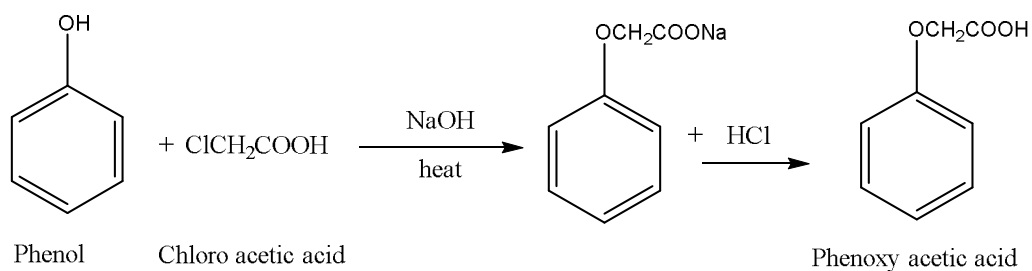

3. Ester formation

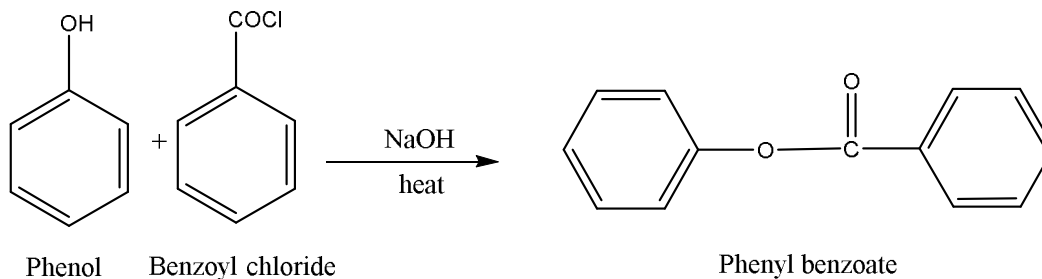
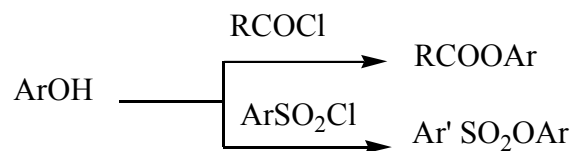

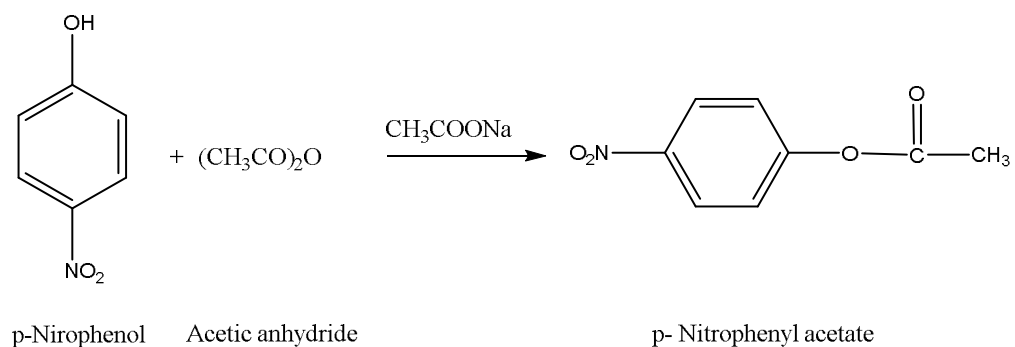

Ring substitution:

-OH and -O⁻ are activate powerfully and direct ortho. and para. in electrophilic aromatic substitution.

-OR is Less powerful activator than -OH.

(a) Nitration

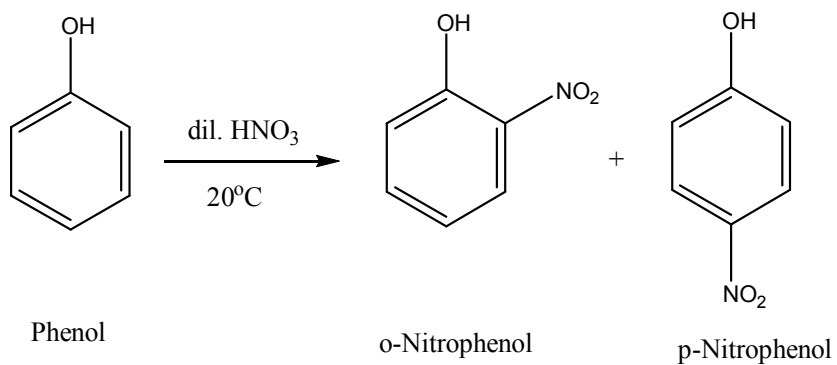

(b) Sulfonation

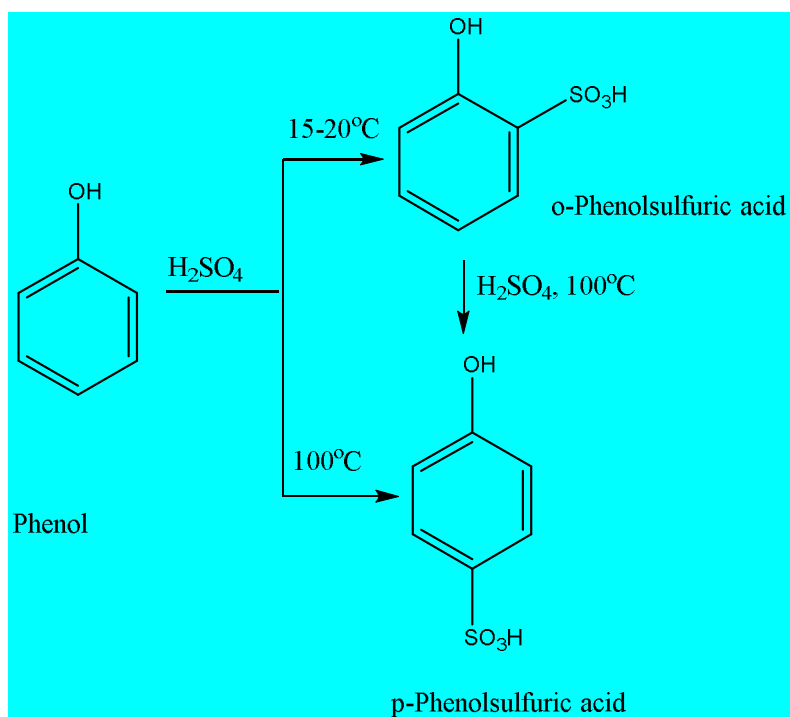

(c) Halogenation

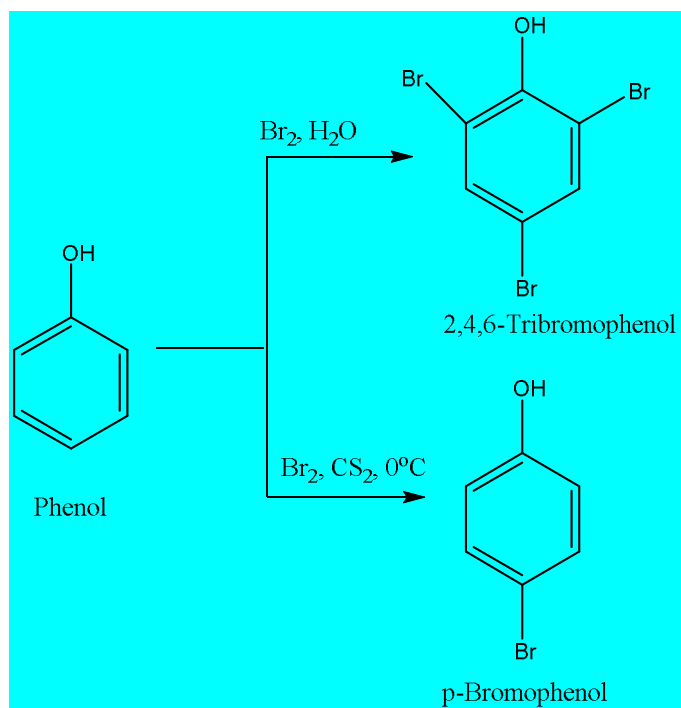

(d) Friedel-Crafts alkylation

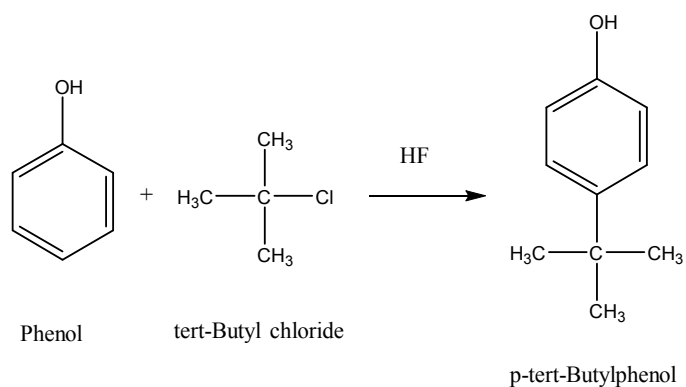

(e) Nitrosation:

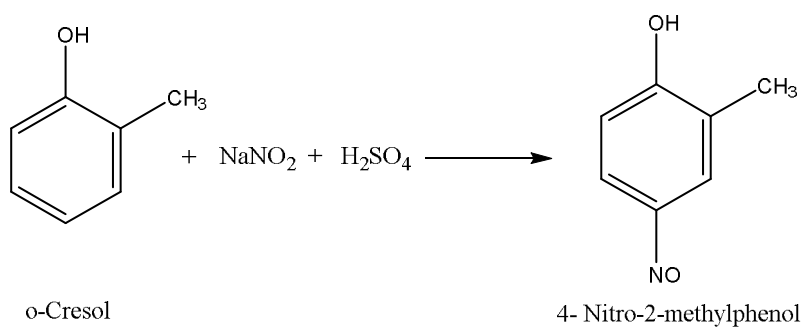

(f) Carbonation: Kolbe reaction

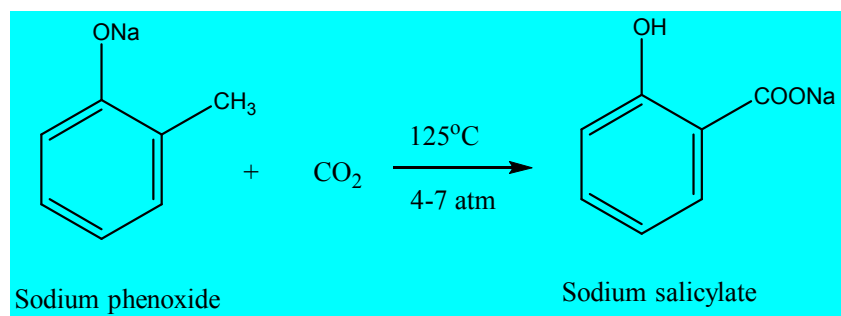

(g) Aldehyde formation: Reimer-Tiemann reaction

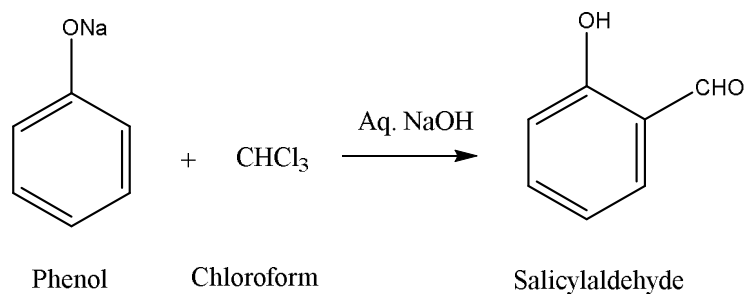

Self Assessment Questions

SAQ18. Give 4 types of name reactions of Phenol.

SAQ19. Define Friedel-Crafts alkylation of Phenol.

2.2.4 Mechanisms of Fries rearrangement, Claisen rearrangement, Gatterman synthesis, Hauben-Hoesch reaction, Lederer-Manasse reaction and Reimer-Tiemann reaction.

Fries rearrangement

Phenols are usually converted into their esters by the action of acids, acid chlorides, or anhydrides. When esters of phenols are heated with aluminum chloride, the acyl group migrates from the phenolic oxygen to an ortho or para position of the ring, thus yielding a ketone. This reaction, called the Fries rearrangement, is often used instead of direct acylation for the synthesis of phenolic ketones.

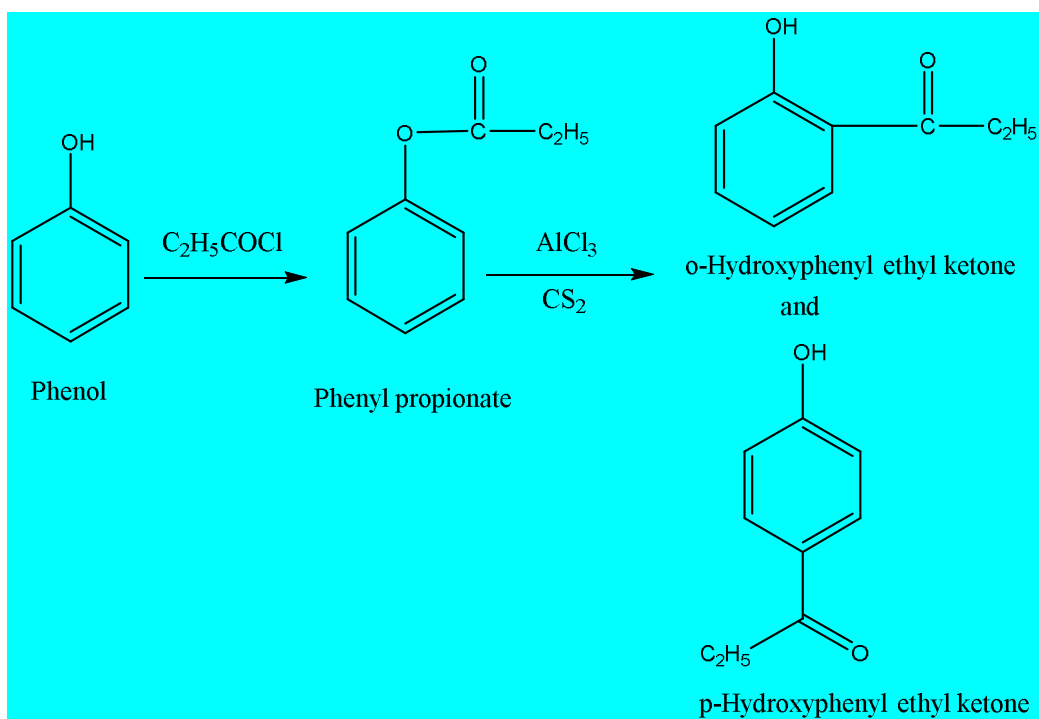

The Claisen rearrangement

The Claisen rearrangement is the first recorded example of a [3,3]-sigmatropic rearrangement. The Claisen rearrangement is an exothermic, concerted pericyclic reaction. Woodward-Hoffmann rules show a suprafacial, stereospecific reaction pathway. The kinetics of the first

order and the whole transformation proceeds through a highly ordered cyclic transition state and is intramolecular.

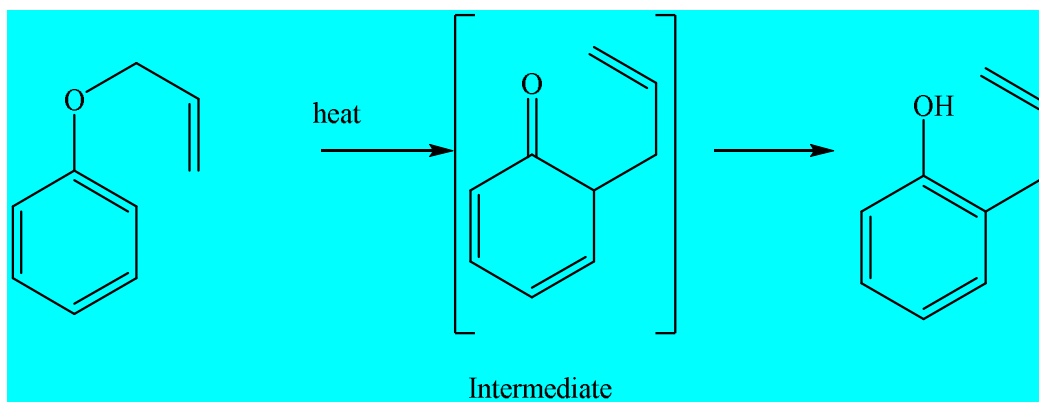

The first reported Claisen rearrangement is the [3,3]-sigmatropic rearrangement of an allylphenyl ether to intermediate, which quickly tautomerizes to an ortho-substituted phenol.

The **Gattermann** reaction, also known as the **Gattermann** aldehyde synthesis is a chemical reaction in which aromatic compounds are formylated by hydrogen cyanide in the presence of a Friedel–Crafts catalyst (e.g. AlCl₃) it is similar to Friedel-Craft reaction.

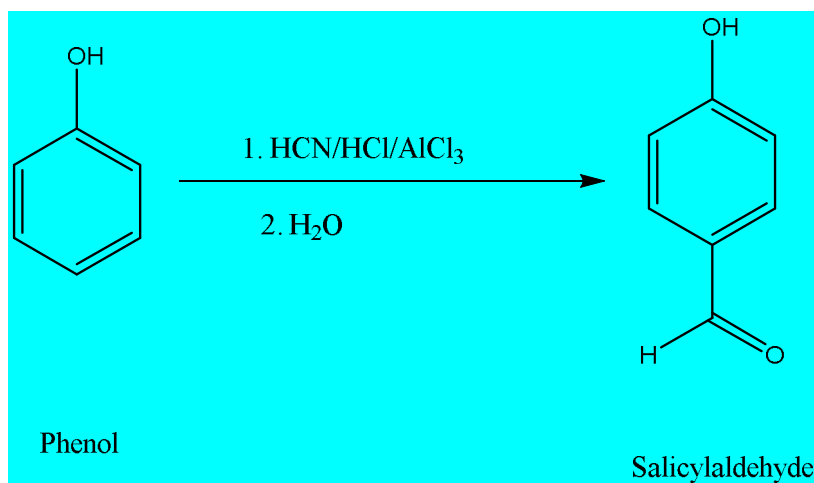

Houben–Hoesch reaction

The Hoesch reaction or Houben–Hoesch reaction is an organic reaction in which a nitrile reacts with an arene compound to form an aryl ketone. The reaction is a type of Friedel-Crafts acylation with hydrogen chloride and a Lewis acid catalyst. The synthesis of 2,4,6-Trihydroxyacetophenone (THAP) from phloroglucinol is representative, If two-equivalents are added, 2,4-Diacetylphloroglucinol is the product.

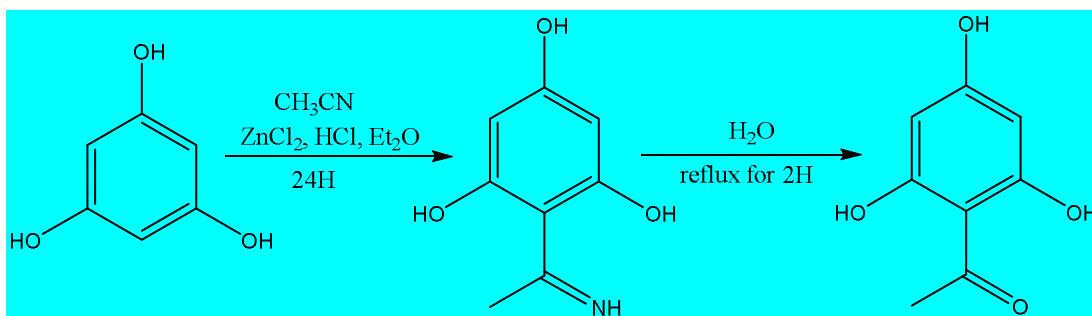

Manasse–Lederer reaction:

The reaction of phenol and formaldehyde under basic condition is referred to as the Manasse–Lederer reaction which form ortho-hydroxy benzyl alcohol and para-hydroxy benzyl alcohol. The resulting products from this reaction is known as shellac substitutes, which are soluble in alcohol, acetone, and alkaline hydroxide and melt on heating and resolidify after cooling.

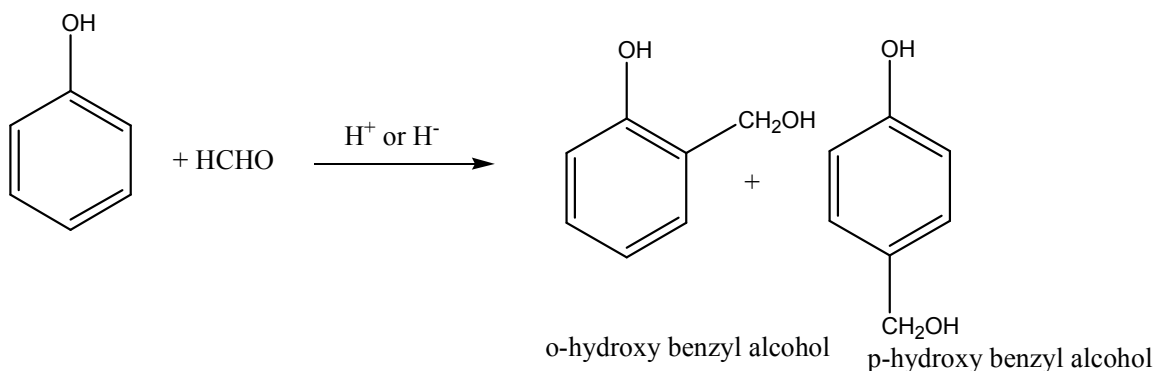

Reimer-Tiemann reaction:

Synthesis of phenolic aldehydes by Dichlorocarbene, were treatment of a phenol with chloroform and aqueous hydroxide introduces an aldehyde group, CHO into the aromatic ring, generally ortho to the OH. This reaction is known as the Reimer-Tiemann reaction.

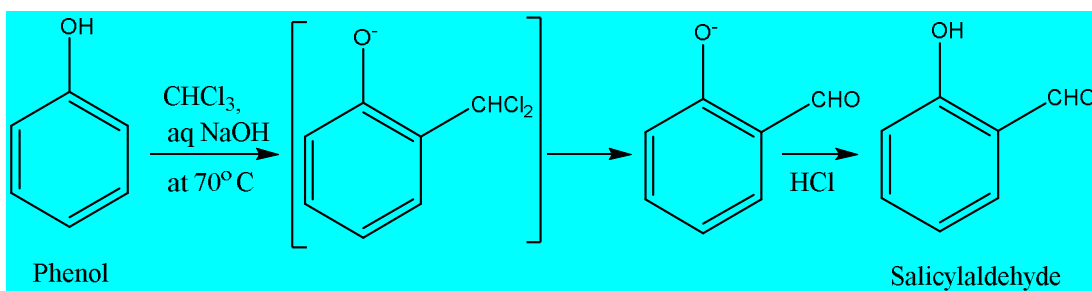

The Reimer-Tiemann reaction involves electrophilic substitution on the highly reactive phenoxide ring. The electrophilic reagent is dichlorocarbene, $:CCl_2$, generated from chloroform

by the action of base. Although electrically neutral, dichlorocarbene contains a carbon atom with only a sextet of electrons and hence is strongly electrophilic.

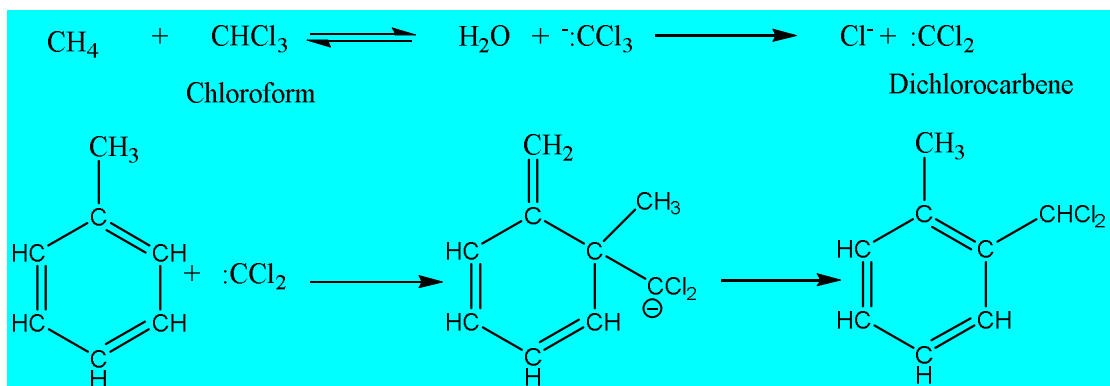

Self Assessment Questions

SAQ -Name reactions where carbene (:CCl₂) is involved in the reaction with Phenol?

SAQ - Name reactions where [3,3]-sigmatropic rearrangement takes place?

2.3 Summary

After studying this unit learner is able to gain enough knowledge to elucidation of alcohols and phenols, how to nomenclature done for them, structure and bonding of alcohols and Phenols. How to syntheses alcohols and phenols by chemical and physical methods. To explain physical properties of alcohol and Phenols and acidic character of alcohols and phenols. Able to explain mechanisms and rearrangement of various reactions. Give about importance and application as well as their use in daily life.

2.4 Terminal Questions

Q1. Which will be most reactive alcohol for dehydration reaction?

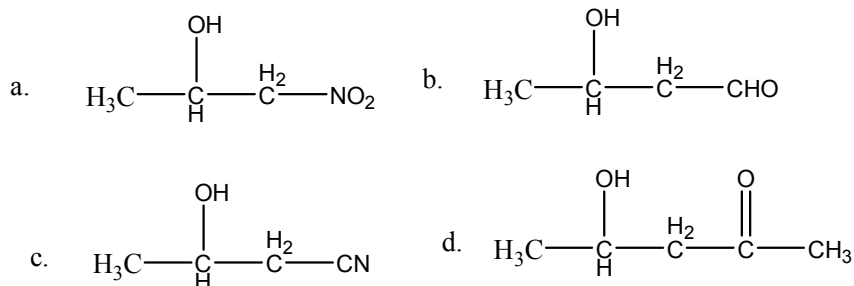

Q2. Give reactivity order of given four alcohols in decreasing order for dehydration reaction.

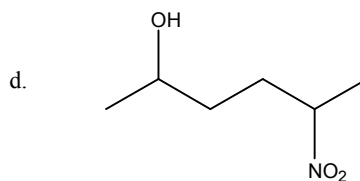
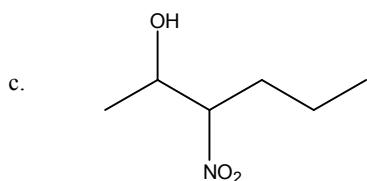
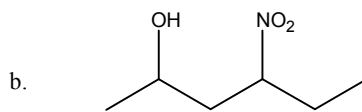
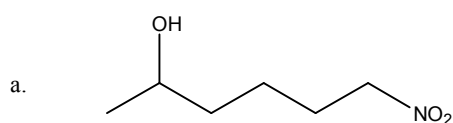

Q3. Describe Synthetic application of Grignard Reagent with example?

Q4. Write CH_3MgCl reaction with $\text{C}_2\text{H}_5\text{OH}$ and $\text{CH}_3\text{COOC}_2\text{H}_5$.

Q5. Name the following alcohols by Carbinol and by IUPAC methods:

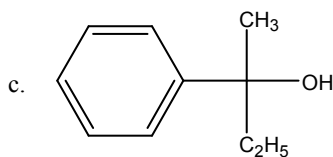
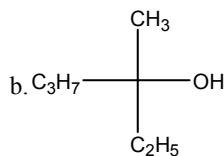
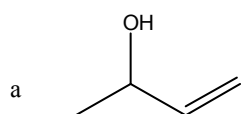

Q. 6. Why? Alcohol has higher boiling point than alkyl halide or alkane of comparable mol. wt.?

Q7. Why alcohols have higher boiling points than ethers of comparable molecular weights.

Q8. Unlike propane or butane, propanol is soluble in water, why?

Q9. Why is n-hexanol insoluble in water?

Q10. Why are lower members of alcohols soluble in water while higher members are not?

Q 11. The boiling point of 1-propanol (molecular mass 60) is 370 K while the boiling point of 1, 2-ethanediol (molecular mass 62) is 470 K. Explain the reason for high boiling point of 1, 2-ethanediol.

Q12. How will you distinguish between primary, secondary and tertiary alcohols?

Q13. Identify A, B, C and D in the following reaction given below:

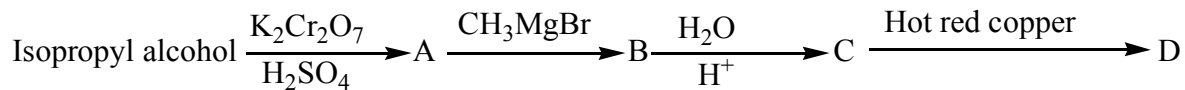

Q1. Ans. A

Q2. Ans. C > B > D > A

Q5. Ans. Carbinol System

IUPAC System

(a) Methyl vinyl carbinol

But-3-en-2-ol

(b) Methyl-ethyl-n-propyl carbinol

3-Methylhexan-3-ol.

(c) Ethyl methyl phenyl carbinol

2-Phenylbutan-2-ol

Q6. Ans. Since in alcohol, ROH strongly electronegative oxygen atom is directly linked to hydrogen atom, its molecules get associated through intermolecular hydrogen bonding as shown below. This increases the molecular mass and hence the boiling point of alcohol rises.

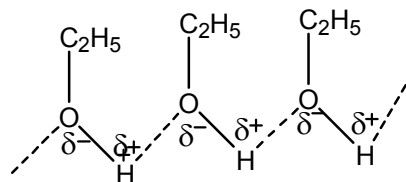

Q7. Ans. Alcohols form intermolecular hydrogen bonding whereas ethers do not. That is why alcohols have higher b.p.

Q8. Ans. Propane molecules cannot join with water molecules through hydrogen bonding as propane has no oxygen-hydrogen bond in its molecule. Consequently, propane is not soluble in water. On the other hand, propanol is soluble in water as its molecule contains -OH bond, which causes propanol molecules to form hydrogen bonds with water molecules as shown below:

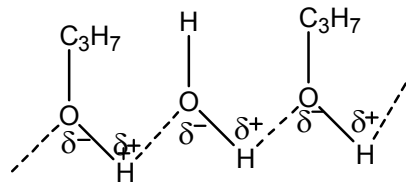

Q9. Ans. Alcohols have the general formula ROH. As the R group becomes larger, ROH resembles more closely with the hydrocarbon. In n-hexanol molecule, the carbon content is quite

high which causes it to resemble closely with hexane (which is not soluble in water). Moreover, the large hexyl ($C_6H_{13}-$) group obstructs the formation of hydrogen bonds between water and n-hexanol molecules. As a result, n-hexanol is not soluble in water.

Q10. Ans. Lower members of alcohols are soluble in water because they form hydrogen bonds with water. Higher members behave more like hydrocarbons which are insoluble in water. Formation of hydrogen bonds in the case of higher members is hindered because of steric reasons as the alkyl groups in such cases are quite bulky. As the hydrogen bond is not formed, they are insoluble in water.

Q11. Ans, Since 1, 2-ethanediol molecule contains two $-OH$ groups, it is capable of forming more intermolecular hydrogen bonds and hence is very highly associated substance. Therefore, its boiling point is very high.

Q12. Ans. The following methods enable us to distinguish between primary, secondary and tertiary alcohols.

(1) Oxidation. Primary, secondary and tertiary alcohols yield different products on oxidation.

A primary alcohol gives an aldehyde and then an acid containing the same number of carbon atoms as the original alcohol. Secondary alcohols form ketones containing the same number of carbon atoms as the original alcohol but further oxidation of ketones occurs only with strong oxidizing agents to form acids containing lesser number of carbon atoms. Tertiary alcohols are very difficult to oxidise but if oxidised they yield ketones and then acids, both containing lesser number of carbon atoms than the alcohol. Thus, the identification of oxidation products can reveal the nature of alcohols.

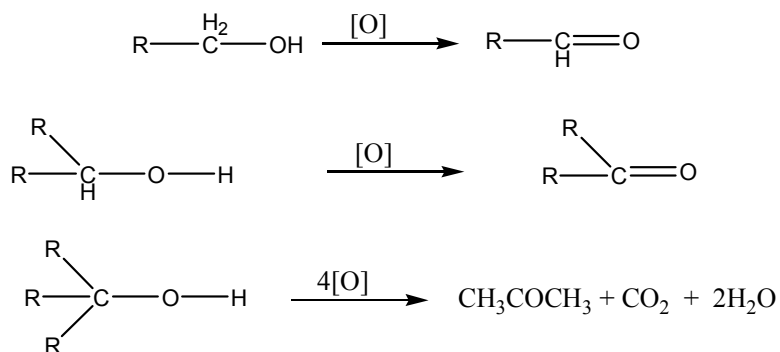

(2) **Reaction with hot reduced copper:** When the vapours of alcohols are passed over hot reduced copper at 473-573 K, primary and secondary alcohols lose hydrogen to form aldehydes and ketones respectively while tertiary alcohols get dehydrated to form alkenes as already explained.

(3) **Lucas test:** This test consists in treating the alcohol with Lucas reagent which is an equimolar mixture of concentrated hydrochloric acid and anhydrous zinc chloride. Appearance of cloudiness in the reaction mixture indicates the conversion of alcohol into alkyl chloride. It has been observed that a tertiary alcohol reacts immediately, a secondary alcohol reacts within five minutes while a primary alcohol does not react appreciably at room temperature.

(4) **Victor Meyer's method:**

The given alcohol is treated with phosphorous and iodine when an alkyl iodide is obtained. It is distilled with silver nitrite to yield the corresponding nitroalkane. The nitroalkane is finally treated with nitrous acid (i.e., sodium nitrite + dil. sulphuric acid) and the solution made alkaline.

Q13.Ans.

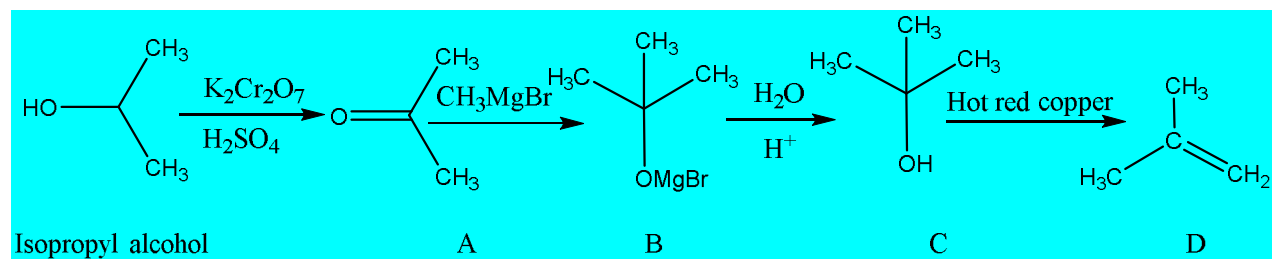

Suggested readings

1. Under Graduate Organic Chemistry, Jagdamba Singh and L.D.S Yadav, Vol. I, Phagati Prakashan, Meerut
2. Organic Chemistry, Robert Thornton Morrison and Robert Neilson Boyd, Prentice-Hall India, Pvt. Ltd., New Delhi.
3. Introduction to Organic Chemistry, John McMurry, Cengage Learning India Pvt. Ltd., New Delhi

Unit 3: Ethers and Epoxide

3.0 Introduction

Objective

3.1 Ethers

3.1.1 Structure and Nomenclature of ethers

3.1.2 Physical properties of ether

3.1.3 Synthesis of ethers

3.1.4 Williamson's synthesis

3.1.5 Preparation of ethers with mercuric trifluoroacetate

3.1.6 Chemical reactions – cleavage and autoxidation

3.1.7 Ziesel's method

3.1.8 Crown ethers

3.2 Epoxides

3.2.1 Synthesis of epoxides

3.2.2 Acid and base-catalyzed ring opening of epoxides,

3.2.3 Reactions of Grignard reagent

3.2.4 Hydroxylation with permanganate and osmium tetroxide

3.3 Summary

3.4 Terminal Questions

3.0 Introduction

Ethers are compounds of the general formula R-O-R, Ar-O-R or Ar-O-Ar. To name ethers we usually name the two groups that are attached to oxygen, and follow these names by the word ether i.e. Ethyl ether, phenyl ether, etc. Cyclic ethers unusual reactivity, these compounds are the epoxides. Epoxides are compounds containing the three-membered ring.

Objective

- Structure and Nomenclature of ethers
- Physical properties of ether
- Syntheses of ethers
- Chemical reactions – cleavage and autoxidation
- Ziesel's method for calculation
- Introduction of Crown ethers
- Types of Epoxides
- Synthesis of epoxides
- Acid and base-catalyzed ring opening of epoxides
- Reactions of Grignards reagent with epoxides

3.1.1 Structure and Nomenclature of ethers

Ethers are compounds of the general formula R-O-R, Ar-O-R or Ar-O-Ar. To name ethers we usually name the two groups that are attached to oxygen, and follow these names by the word ether i.e. Ethyl ether, phenyl ether, Methyl tert-butyl ether, Isopropyl phenyl ether, etc. If one group has no simple name, the compound may be named as an alkoxy derivative like 2-methoxyhexane, 2-ethoxy ethanol, etc. As aromatic compounds aryl alkyl ether has simple name of Anisole. If the two groups are identical, the ether is said to be symmetrical and if different, unsymmetrical.

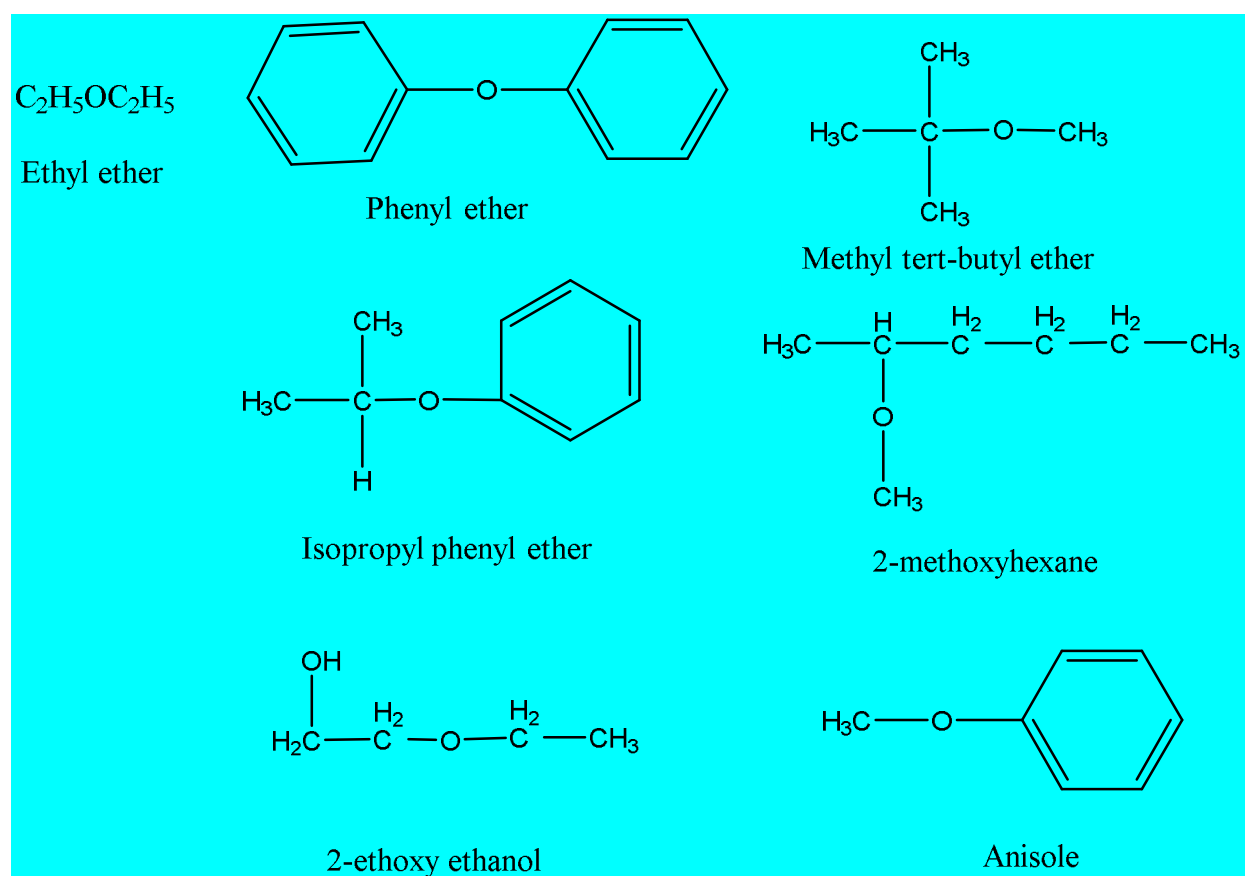

3.1.2 Physical properties of ethers

Since the C-O-C bond angle is not 180° , the dipole moments of the two C-O bonds do not cancel each other; consequently, ethers possess a small net dipole moment e.g. for ethyl ether is , 1.18 D.

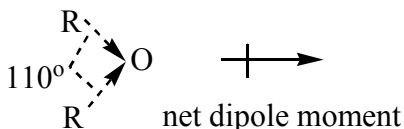

This polarity does not affect the boiling points of ethers, which are about the same as those of alkanes having comparable molecular weights and much lower than those of isomeric alcohols. Boiling points of n-heptane is 98°C , methyl n-pentyl ether 100°C , and n-hexyl alcohol is 157°C . The hydrogen bonding that holds alcohol molecules strongly together is not possible for ethers, since they contain hydrogen bonded only to carbon. Other hand, ethers show a solubility in water comparable to that of the alcohols, both ethyl ether and n-butyl alcohol, being soluble to the extent of about 8 g per 100 g of water.

3.1.3 Synthesis of ethers

Ethers are prepared by reactions of the corresponding alcohols with sulfuric acid. Since a molecule of water is lost for every pair of alcohol molecules, the reaction is a kind of dehydration. Dehydration is generally limited to the preparation of symmetrical ethers, because, as we might expect a combination of two alcohols usually yields a mixture of three ethers.

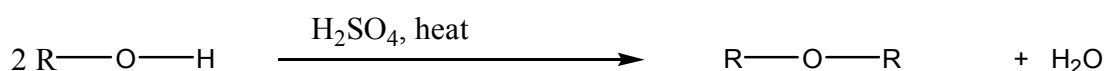

Ether formation by dehydration is an example of nucleophilic substitution with the protonated alcohol as substrate and a second molecule of alcohol as nucleophile.

Ethanol and dimethyl ether are isomers because they have the same molecular formula, $\text{C}_2\text{H}_6\text{O}$. More specifically, they are constitutional isomers because the atoms in each compound are connected differently. The oxygen in ethanol is bonded to a carbon and to a hydrogen, while the oxygen in dimethyl ether is bonded to two carbon.



3.1.4 Williamson synthesis

In the Williamson synthesis of ethers is important because of its versatility. it can be used to make unsymmetrical ethers as well as symmetrical ethers and aryl alkyl ethers as well as dialkyl ethers. In the Williamson synthesis an alkyl halide or substituted alkyl halide is allowed to react with a sodium alkoxide or a sodium phenoxide.

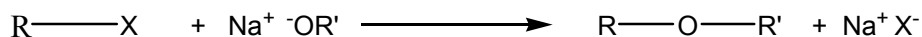

In the Williamson synthesis involves of nucleophilic substitution of alkoxide ion or phenoxide ion for halide ion, it is strictly analogous to the preparation of alcohols by treatment of alkyl halides with aqueous hydroxide.

In planning a Williamson synthesis of a dialkyl ether, we must always keep in mind that the tendency for alkyl halides to undergo dehydrohalogenation is $3^\circ > 2^\circ > 1^\circ$.

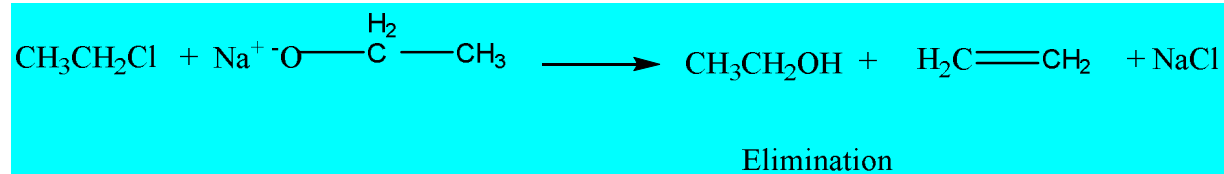
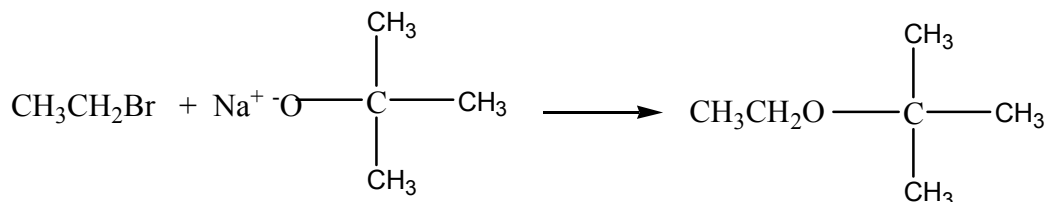

For the preparation of an aryl alkyl ether there are again two combinations to be considered, here, one combination can usually be rejected out of hand. n-Propyl phenyl ether, can be prepared only from the alkyl halide and the phenoxide, since the aryl halide is quite unreactive toward alkoxides.

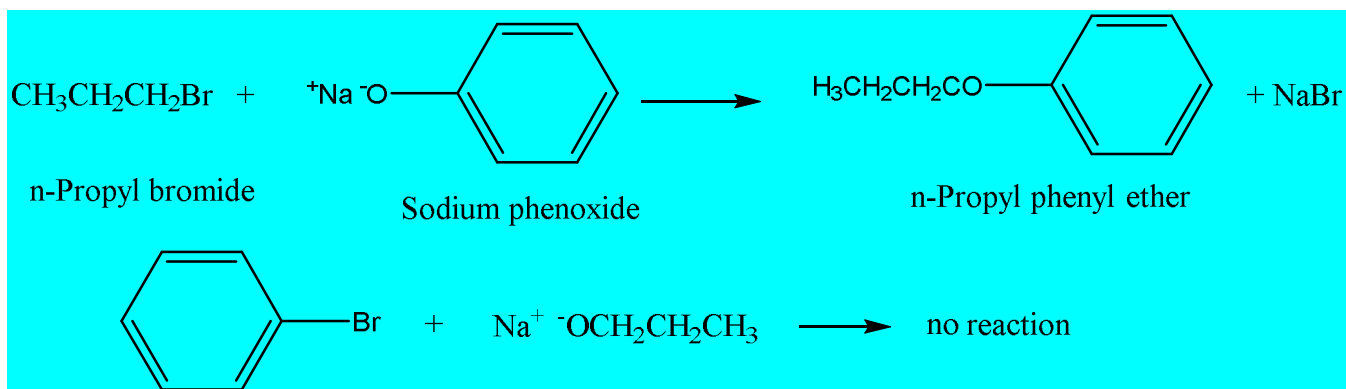

3.1.5 Preparation of ethers with mercuric trifluoroacetate

Alkenes react with mercuric trifluoroacetate in the presence of an alcohol to give alkoxymercurial compounds which on reduction yield ethers.

We recognize this two-stage process as the exact analog of the oxymercuration- demercuration synthesis of alcohols. In place of water use of an alcohol which, not surprisingly, can play exactly the same role. Instead of introducing the hydroxy group to make an alcohol, an alkoxy group to make an ether. This example of solvomercuration-demercuration amounts to Markovnikov addition of an alcohol to a carbon-carbon double bond.

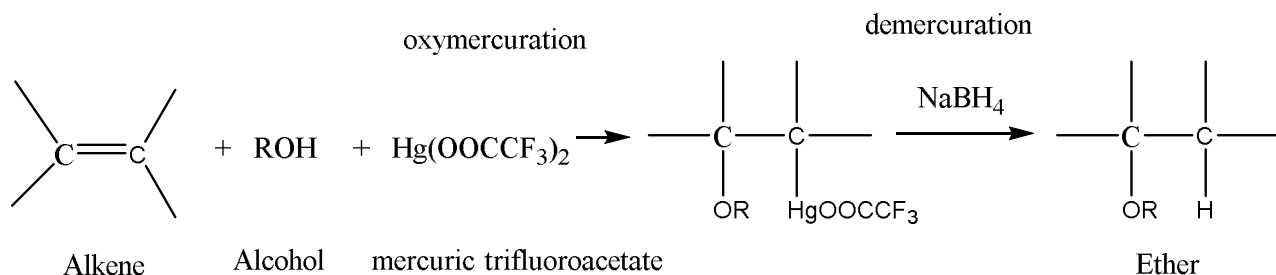

Compared with the Williamson synthesis, it has one tremendous advantage, there is no competing elimination reaction. As a result, it can be used for the synthesis of nearly every kind of alkyl ether.

3.1.6 Chemical reactions cleavage and autoxidation

Reactions of ethers, Cleavage by acids:

Cleavage by acids Ethers are comparatively unreactive compounds. The ether linkage is quite stable toward bases, oxidizing agents and reducing agents, so far as the ether linkage itself is

concerned, ethers undergo just one kind of reaction, cleavage by acids. Cleavage takes place only under quite vigorous conditions, concentrated acids usually HI or HBr and at high temperatures.

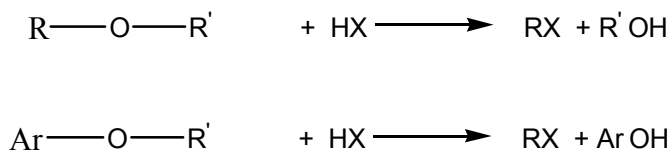

Reactivity of HX: **HI > HBr > HCl**

3.1.7 Ziesel's method

A method for determining the number of methoxy ($-\text{OCH}_3$) groups in an organic compound. The compound is heated with excess hydriodic acid, forming an alcohol and iodomethane,

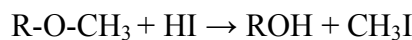

The iodomethane is distilled off and led into an alcoholic solution of silver nitrate, where it precipitates silver iodide. This is filtered and weighed, and the number of iodine atoms and hence methoxy groups can be calculated. The method was developed by S. Ziesel in 1886.

Cleavage of Oxonium salts:

Like water, many organic compounds that contain oxygen can act as bases and accept protons, ethyl alcohol and diethyl ether, form *oxonium ions*, *protonated alcohol* and *protonated ether respectively*.

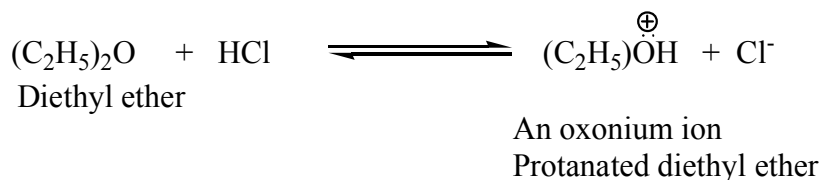
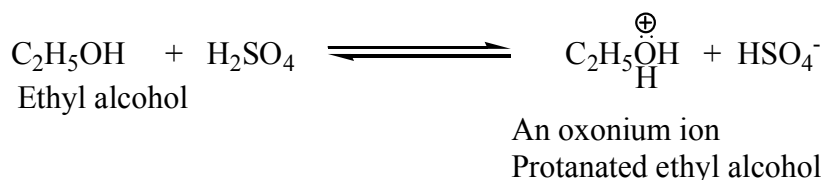

3.1.8 Crown ethers

Crown ethers are cyclic chemical compounds consist of a ring containing several ether groups. The most common crown ethers are cyclic oligomers of ethylene oxide is the repeating unit being ethyleneoxy, i.e., $-\text{CH}_2\text{CH}_2\text{O}-$. Important members of this series are the tetramer ($n = 4$), the pentamer ($n = 5$) and the hexamer ($n = 6$). The term "crown" refers to the resemblance between the structure of a crown ether bound to a cation, and a crown sitting on a person's head. Structures of common crown ethers: 12-crown-4, 15-crown-5 and 18-crown-6. The first number in a crown ether's name refers to the number of atoms in the cycle and the second number refers to the number of those atoms that are oxygen.

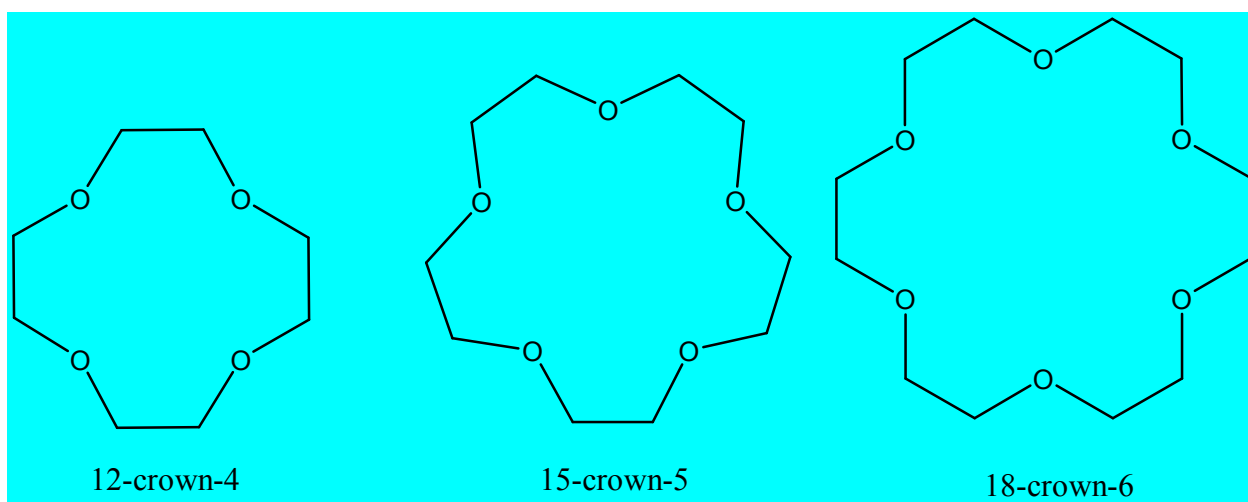

Crown ethers strongly bind certain cations forming complexes. The oxygen atoms are well situated to coordinate with a cation located at the interior of the ring, whereas the exterior of the ring is hydrophobic. The resulting cations often form salts that are soluble in nonpolar solvents and for this reason crown ethers are useful in phase transfer catalysis.

The denticity of the polyether influences the affinity of the crown ether for various cations. For example, 12-crown-4 for lithium cation (Li^+), 15-crown-5 for sodium cation (Na^+) and 18-crown-6 has high affinity for potassium cation (K^+).

The high affinity of 18-crown-6 for potassium ions contributes to its toxicity. The smallest crown ether still capable of binding cations is 8-crown-4. Crown ethers are not the only macrocyclic ligands that have affinity for the potassium cation. Ionophores such as valinomycin also display a marked preference for the potassium cation over other cations.

Comparison of Cavity Size with Effective Ion Radii of Alkali metals

Crown ether	Cavity Size (Å)	Favored Alkali ion	Effective Ion Radii (Å)
12-crown-4	0.6-0.75	Li ⁺	0.76
15-crown-5	0.86-0.92	Na ⁺	1.02
18-crown-6	1.34-1.55	K ⁺	1.38

3.2 Epoxides

Cyclic ethers of one class deserve special attention because of their unusual reactivity, these compounds are the epoxides. Epoxides are compounds containing the three-membered ring.

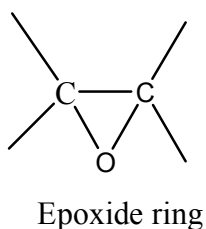

3.2.1 Synthesis of epoxides

They are ethers but the three-membered ring gives them unusual properties. By far the most important epoxide is the simplest one, ethylene oxide. It is prepared on an industrial scale by catalytic oxidation of ethylene by air.

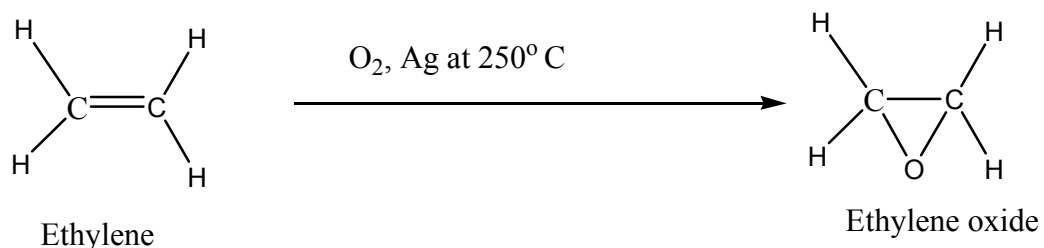

Epoxide by peroxidation of carbon-carbon double bonds:

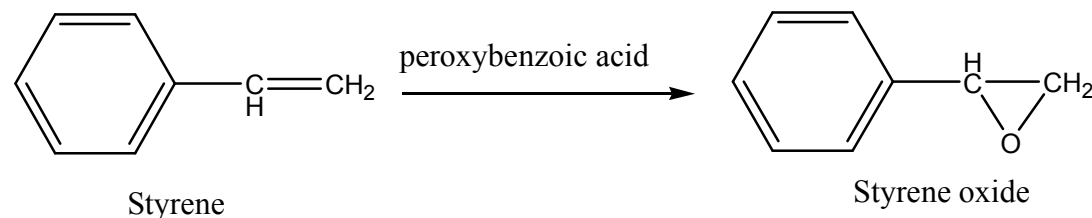

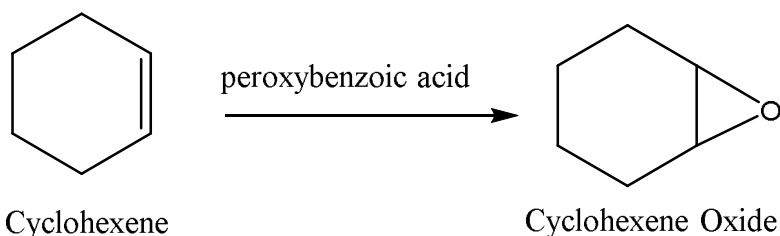

Epoxides by halohydrins:

The conversion of halohydrins into epoxides by the action of base is simply an adaptation of the Williamson synthesis, a cyclic compound is obtained because both alcohol and halide happen to be part of the same molecule. In the presence of hydroxide ion a small proportion of the alcohol exists as alkoxide; this alkoxide displaces halide ion from another portion of the same molecule to yield the cyclic ether.

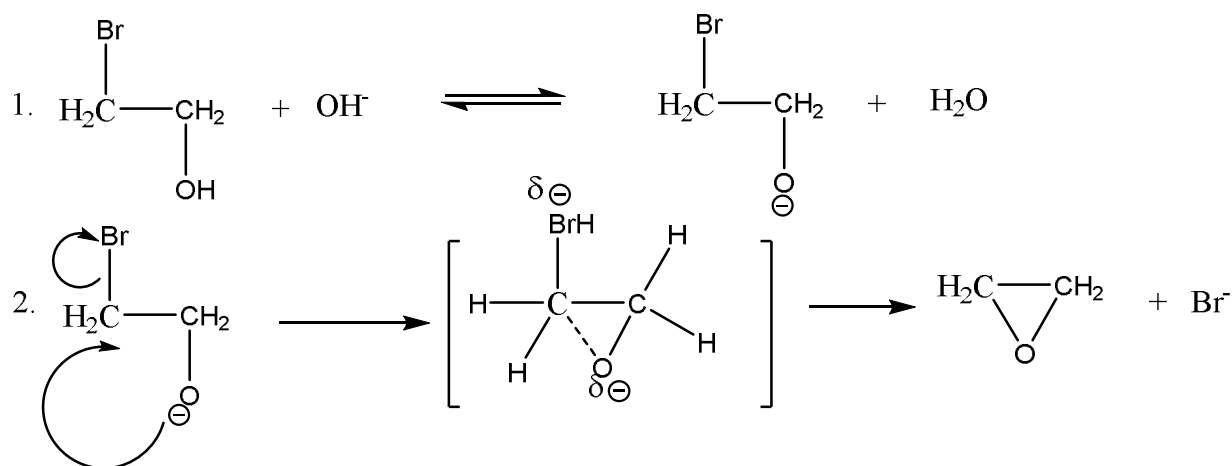

Epoxides undergo acid-catalyzed reactions with extreme ease, and unlike ordinary ethers can even be cleaved by acid and bases.

3.2.2 Acid and base-catalyzed ring opening of epoxides

Acid-catalyzed cleavage:

Like other ethers, an epoxide is converted by acid into the protonated epoxide, which can then undergo attack by any of a number of nucleophilic reagents. An important feature of the reactions of epoxides is the formation of compounds that contain two functional groups. Thus, reaction with water yields a glycol, reaction with an alcohol yields a compound that is both ether and alcohol.

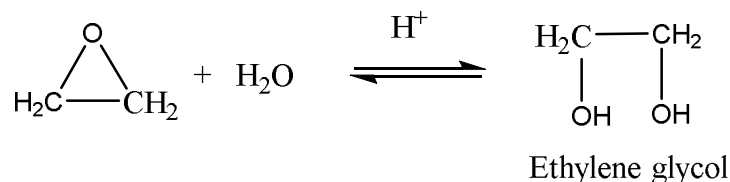

Base-catalyzed cleavage:

Epoxides can be cleaved under alkaline conditions. Here it is the epoxide itself not the protonated epoxide, that undergoes nucleophilic attack. The lower reactivity of the non-protonated epoxide is compensated for by the more basic, more nucleophilic reagent as alkoxide, phenoxide, ammonia, etc

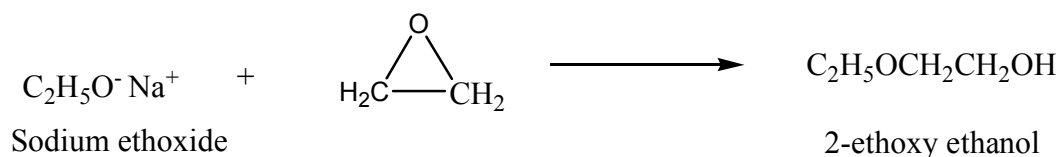

3.2.3 Reaction with Grignard reagents

Grignard reagent attach itself to the relatively positive carbon and the electrophilic magnesium attach itself to the relatively negative oxygen. Use of higher epoxides is complicated by rearrangements and formation of mixtures.

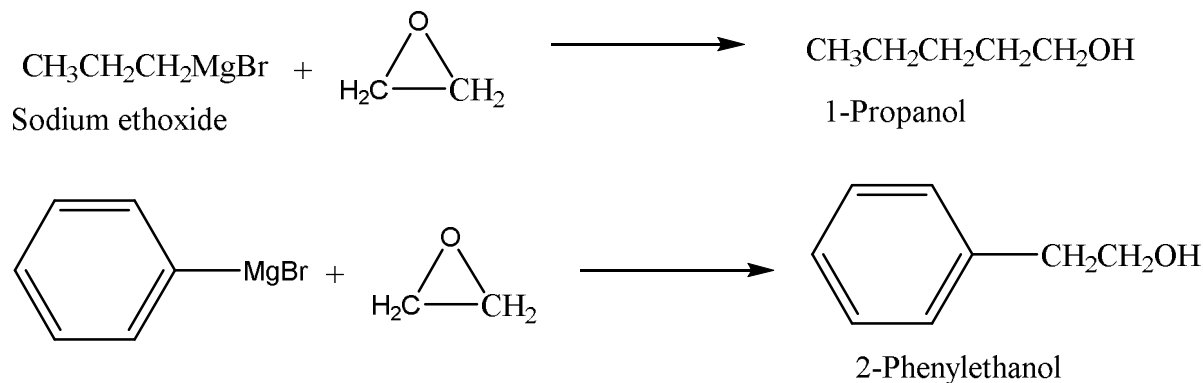

3.2.4 Hydroxylation with permanganate and osmium tetroxide

Hydroxylation with permanganate gives syn-addition. To account for this stereochemistry it has been suggested that an intermediate like is involved.

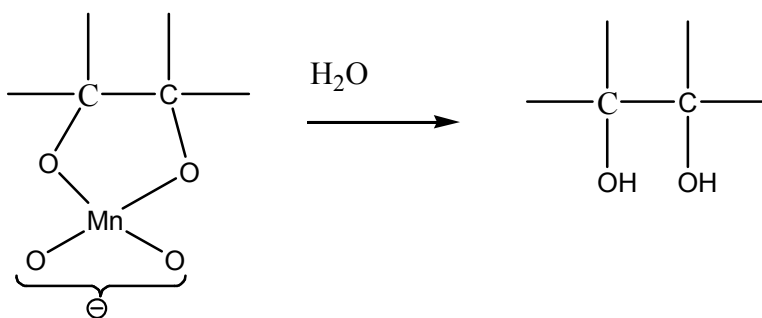

Hydrolysis of such an intermediate would yield the cis-glycol. This mechanism is supported by the fact that osmium tetroxide, OsO_4 , which also yields the cis-glycol, actually forms stable intermediates of structure.

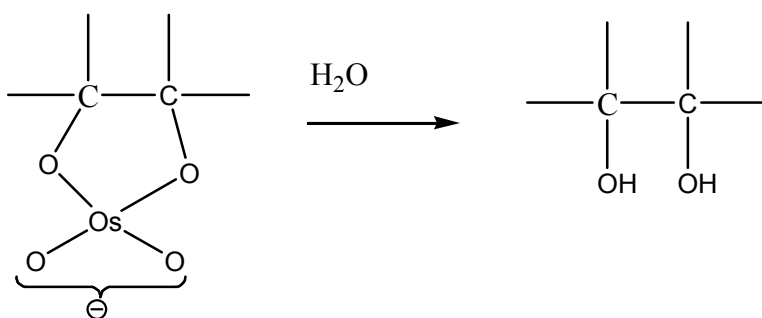

3.3 Summary

After studying this unit learner is able to explain the Structure and Nomenclature of ethers, their Physical properties, Syntheses and Chemical reactions – cleavage and autoxidation. Also came to know about Ziesel's method for calculation, about Crown ethers and their application and importance, types of Epoxides, Synthesis, Acid and base-catalyzed ring opening of epoxides and reactions of Grignards reagent, potassium permagent and osmium tetra oxides with epoxides.

3.4 Terminal Questions

- Q1. Describe briefly nomenclature of ethers?
- Q2. Describe with mechanism the preparation of ethers by dehydration of alcohols?
- Q3. Describe preparation of methyl ethers using diazomethane.
- Q4. Why cannot diphenyl ether be prepared by dehydration of phenol with conc. H_2SO_4 ?
- Q5. Describe preparation of ethers by epoxidation of alkenes.

Q6. How would you convert ethanol into ethoxy ethane and vice-versa?

Q.7. How do you say that ethers have weak basic character?

Terminal Question Answers

Q1. Ans. There are two systems of naming ethers.

(i) Common system

(ii) IUPAC system

These are described separately as under :

(i) Common system. According to this system, the alkyl or aryl groups on either side of oxygen are identified. The compound is named by writing these groups in alphabetical order followed by the word 'ether'.

(ii) IUPAC system. According to this system, ethers are considered as alkoxy derivatives of hydrocarbons. In the case of unsymmetrical ethers, the group having greater no. of carbon atoms is taken as the parent alkane and the other group along with the oxygen is taken as the alkoxy group. Common and IUPAC names of some common compounds are tabulated below.

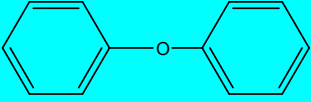
Compound	Common name	IUPAC name
CH_3OCH_3	Dimethyl ether	Methoxymethane
$\text{C}_2\text{H}_5\text{OC}_2\text{H}_5$	Diethyl ether	Ethoxyethane
$\text{CH}_3\text{O C}_2\text{H}_5$	Ethyl methyl ether	Methoxyethane
	Diphenyl ether	Phenoxybenzene

Q2. Ans. Dehydration of alcohols, When an excess of alcohol is heated with concentrated sulphuric acid at suitable temperature, two moles of the alcohol lose one mole of water to form a symmetrical ether. Thus,

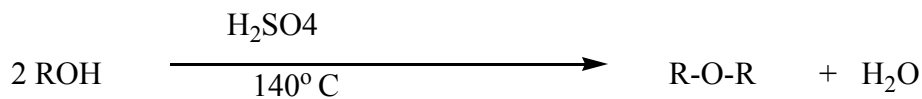

Example,

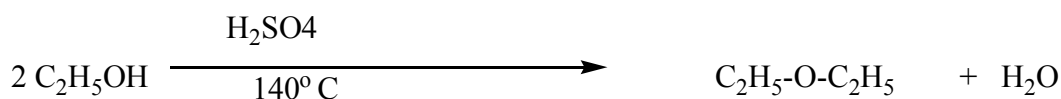

Ethyl alcohol

Diethyl ether

The formation of alkenes, which is a competing reaction, is suppressed by the use of excess of alcohol and regulation of temperature.

Q3. Ans. Preparation of methyl ethers by the use of diazomethane. In the presence of fluoroboric acid, diazomethane reacts with alcohols or phenols to produce ethers in excellent yields. For example, n-hexyl alcohol, C₆H₁₃OH, is easily converted into hexyl methyl ether by this method.

Mechanism

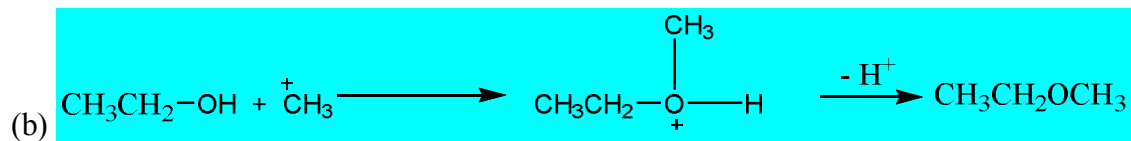
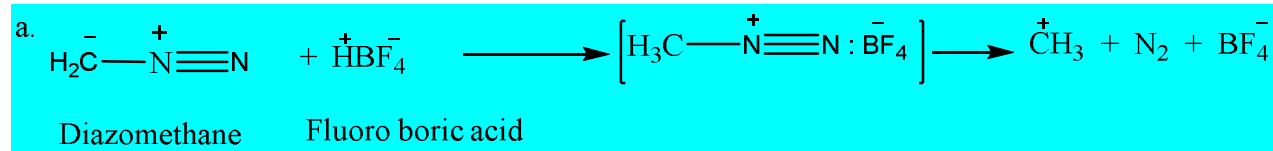

Q4. Ans. Diphenyl ether cannot be prepared by dehydration of phenol with conc. H₂SO₄, due to the following reasons :

- (i) Phenol is attacked by sulphuric acid to form hydroxy benzene sulphonic acids.
- (ii) In case of phenols, initial protonation leading to oxonium ion does not take place readily because the oxygen atom in phenol has some positive charge (i.e., less electron density) as the

electrons of the oxygen atom tend to enter the benzene ring.

Q5. Ans. Preparation of epoxides : Epoxidation of alenes, Epoxides are prepared by reaction between an alkene and an organic peroxy acid (also known as peracids). The reaction is known as epoxidation.

When a solution of peroxy acid and alkene in ether or chloroform is allowed to react, epoxide is formed.

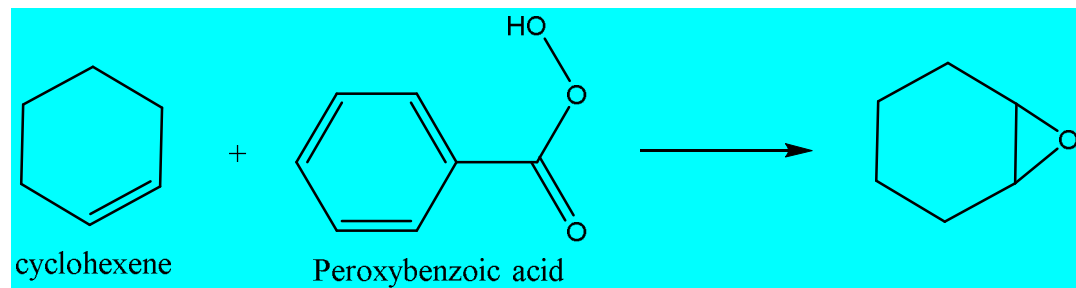
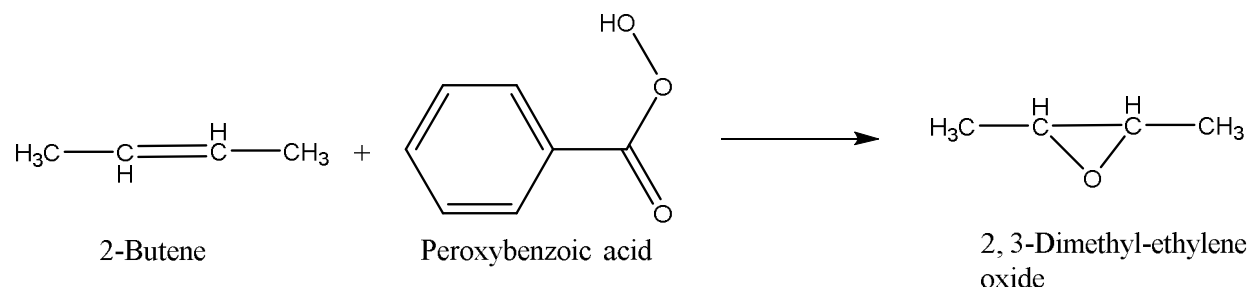

Q6. Ans, (i) Ethanol into ethoxyethane.

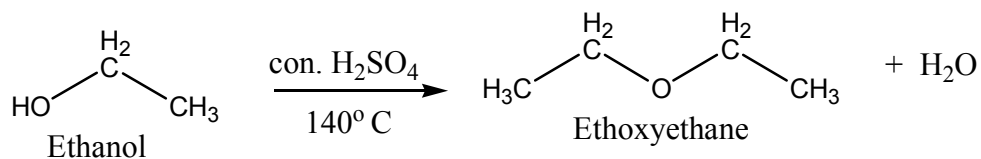

(ii) Ethoxyethane into ethanol

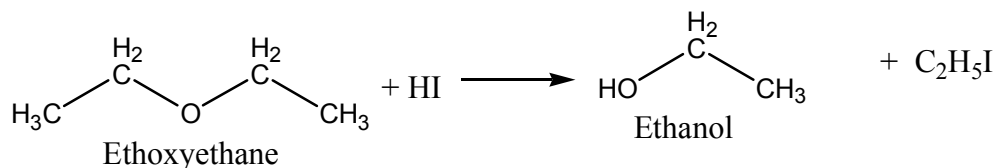

sQ7. Ans. Ethers have the structure R-O-R' There are two lone pairs of electrons on oxygen in the molecule. Ethers can donate these electrons and thus they have basic character. However, they have weak basic nature as they can dissolve only in strong mineral acids like HCl or H₂SO₄ forming salts.

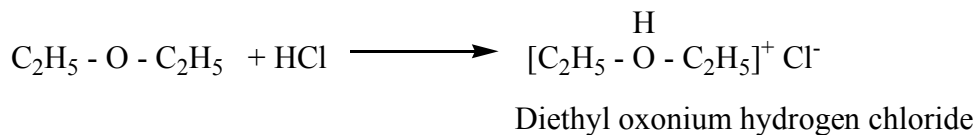

Suggested readings

4. Under Graduate Organic Chemistry, Jagdamba Singh and L.D.S Yadav, Vol. I, Phagati Prakasan, Meerut
5. Organic Chemistry, Robert Thornton Morrison and Robert Neilson Boyd, Prentice-Hall India, Pvt. Ltd., New Delhi.
6. Introduction to Organic Chemistry, John McMurry, Cengage Learning India Pvt. Ltd., New Delhi

Unit 4: Aldehydes and Ketones

Introduction

Objective

4.1 Structure of the carbonyl groups

4.2 Nomenclature of Aldehydes

4.3 Nomenclature of Ketones

4.4 Methods of Preparation

1. Oxidation of alcohols
2. Oxidation of alkanes (Ozonolysis)
3. Hydration of alkynes
4. Hydrolysis of gem-dihalides
5. Pyrolysis of calcium salts of acid
6. Catalytic decomposition of acids
7. Reduction of acid chlorides
8. Oxo process
9. Wacker process

4.5 Physical properties

4.6 Chemical Properties

1. Nucleophilic addition reactions
2. Base-Catalysed Addition
3. Acid catalysed addition
4. Acidity of Hydrogens

4.7 Chemical Reactions

A. Addition Reactions

1. Addition of sodium bisulphite
2. Addition of hydrogen cyanide
3. Addition of Grignard reagents
4. Addition of ammonia

B. Addition reactions followed by loss of water

1. Addition of alcohol

C. Reaction with Ammonia derivatives

1. Reaction with hydroxylamine
2. Reaction with hydrazine
3. Reaction with phenylhydrazine
4. Reaction with 2,4- dinitrophenylhydrazine
5. Reaction with Semicarbazide

D. Reactions Involving Alkyl Groups

1. Aldol condensation
2. Mixed Aldol condensation
3. Chlorination

E. Reduction reactions

1. Reduction to alcohols
2. Reduction to Alkane
3. Clemmenson reduction
4. Reduction to pinacols

F. Oxidation reaction

1. Oxidation of aldehyde
2. Tollens reagent
3. Fehling solution
4. Oxidation of ketones

F. Some other important reactions

1. Haloform reactions
2. Cannizzaro reaction
3. Reformatsky Reaction
4. Wittig's Reaction
5. Reaction with Phosphorus Pentachloride
6. Schiff's Test
7. Polymerization

Formaldehyde Preparation

1. Reaction with ammonia
2. Reaction with sodium hydroxide (Cannizzaro reaction)
3. Reaction with alcohols
4. Polymerization
5. Condensation with phenol

Acetaldehyde Preparation

1. Laboratory Preparation
2. Manufacture
3. By air oxidation of ethanol
4. By dehydrogenation of ethanol
5. By hydration of acetylene
6. By Wacker process
7. Properties (Physical)

4.7 Terminal Questions

Introduction

Both aldehydes and ketones contain carbon - oxygen double bond ($>C=O$). This unit is referred to as carbonyl group.

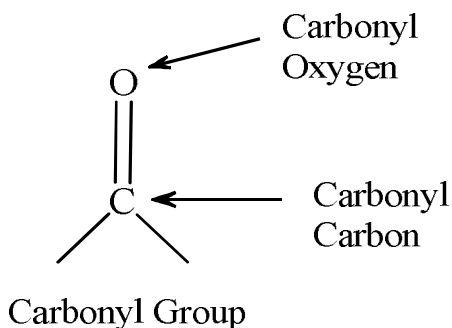

Aldehydes and ketones are collectively called carbonyl compounds. In aldehydes, the carbonyl carbon is bond to 1 hydrogen and alkyl group. Formal-dehyde $H.CHO$, in which the carbonyl

carbon is bonded to two hydrogen atoms in an exception. In ketones, the carbonyl carbon is always bonded to two alkyl groups. These alkyl groups maybe same or different.

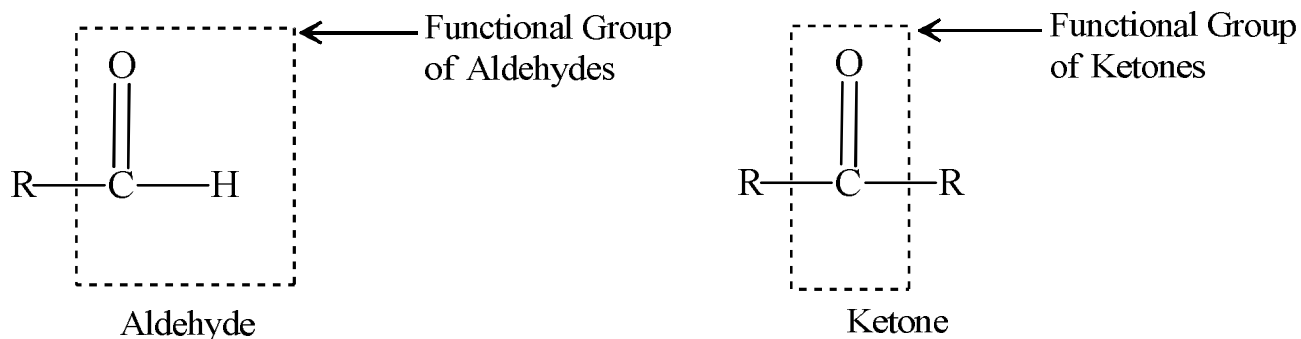

Most of the properties of aldehydes and ketones are a result of the presence of the carbonyl group.

Objective

Learner will be able to define:

- Nomenclature and Structure of the carbonyl groups
- Methods of Preparation of aldehyde and ketones
- Physical properties and Chemical Properties of aldehyde and ketones
- Chemical Reactions of aldehyde and ketones
- Some other important reactions of the carbonyl groups

4.1 Structure of the carbonyl group

The carbonyl group, like the carbon-oxygen double bond of alkenes, is composed of one π bond and one σ bond.

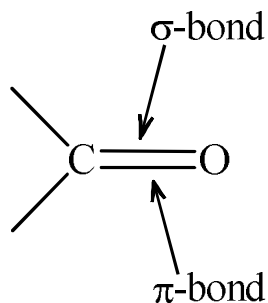

Both the carbon and oxygen are sp^2 hybridised. The sigma bond is formed by the overlap of an sp^2 orbital of carbon and sp^2 orbital of oxygen. The Pi bond is formed by the overlap of unhybridized p orbitals of the two atoms. The two unshared electron pairs of oxygen occupy the sp^2 hybrid orbitals of oxygen. Because the carbon-oxygen is between sp^2 hybridised, the three atoms attached to it lie in the same plane. The bond angles between the attached atoms are approximately 120 degree (Fig. 19.1).

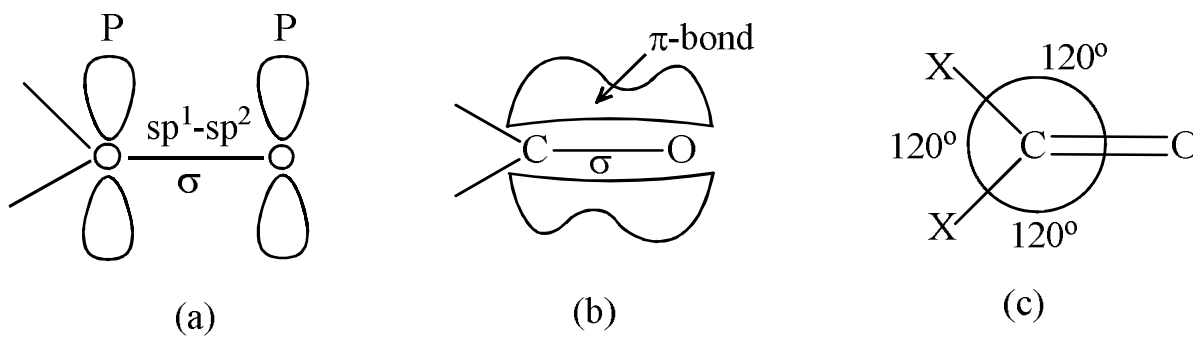

(Fig. 19.1) The carbon oxygen double bond in aldehydes and ketones is composed of a sigma bond and a Pi bond. (a) The sigma bond is formed by the overlap of an sp^2 orbital of carbon and sp^2 orbital of oxygen; (b) The Pi bond is formed by the overlap of the unhybridized p orbitals (c) Geometry of the carbonyl group.

The electrons of the Pi bond of the carbonyl group are not equally shared. In fact, they are pulled more towards the more electronegative oxygen atom. As a result, the bond is polarized, with the oxygen atom being slightly negative (δ^-) and the carbon atom being slightly positive (δ^+). This is often indicated as:

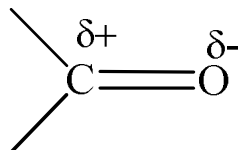

Alternatively, the polar nature of the carbonyl group can also be indicated by the following resonance structures.

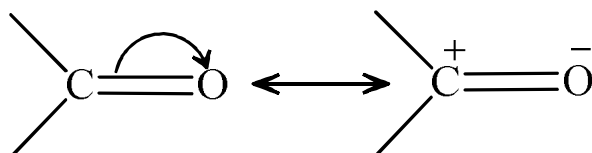

4.2 Nomenclature of aldehydes

There are two systems of naming aldehydes

- (1) **Common system:** common names for aldehydes are obtained from the names of corresponding carboxylic acids. Aldehyde name is obtained by replacing the ending -ic acid name with aldehyde.

Carboxylic Acid

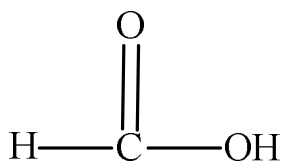

Formic Acid

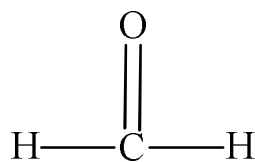

Formaldehyde

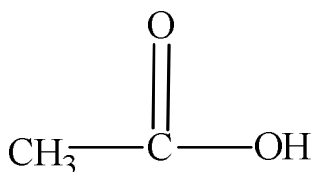

Acetic Acid

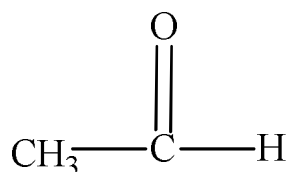

Acetaldehyde

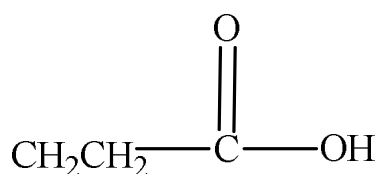

Propionic Acid

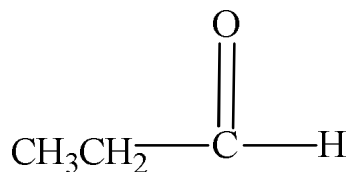

Propionaldehyde

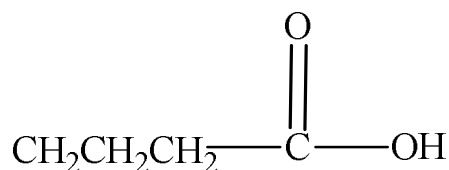

Butyric Acid

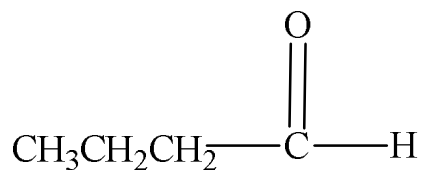

Butyraldehyde

While naming substituted aldehydes, the position of substituents on the parent chain is indicated by Greek letters α , β and γ etc. The carbon atom adjacent to the carbonyl group in an aldehyde is called the α -carbon the next one along the chain is the β -carbon and so forth.

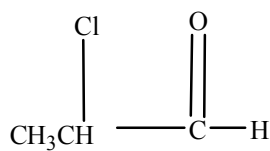
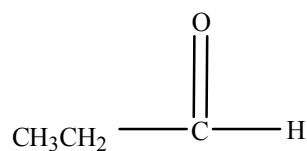

α -Chloropropionaldehyde

(2). IUPAC system: IUPAC names for aldehydes are obtained by replacing the ending -e of the corresponding alkane with -al. Since the aldehyde functional group is always at the end of the chain, there is no need to specify its position. However, names of some aldehydes are given below:

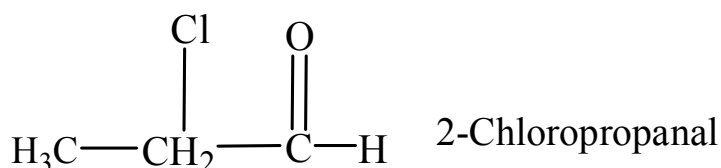
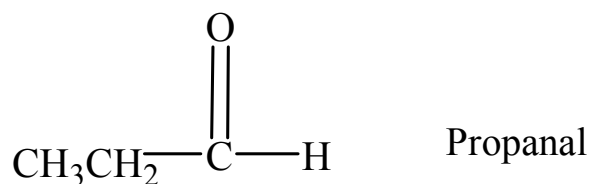
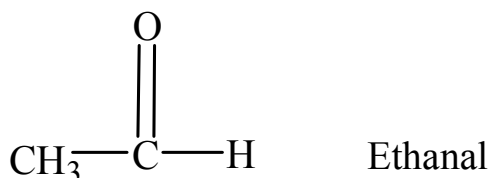

4.3 Nomenclature of Ketones

There are two systems of naming ketones.

(1) Common system: Common names of ketones are obtained by simply naming the two alkyl groups attached to the carbonyl group and adding the word ketone. The simplest ketone on dimethyl ketone is usually referred to as acetone

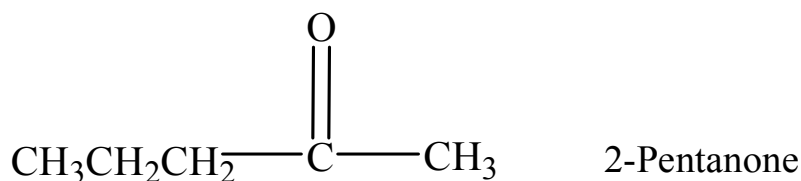
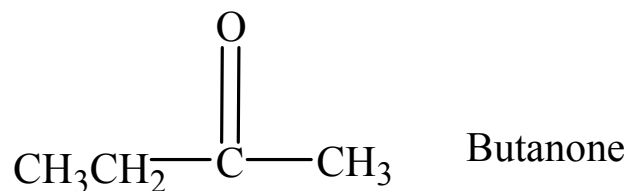
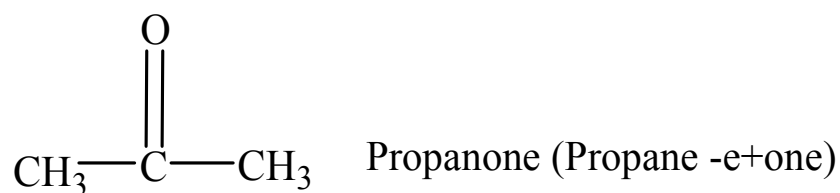

4.4 Methods of Preparation

Aldehydes and ketones may be prepared by the following methods

(1) **Oxidation of alcohols:** Aldehydes and ketones can be prepared by the control oxidation of primary and secondary alcohol using an acidified solution of potassium dichromate or permanganate. Primary alcohols produce aldehydes.

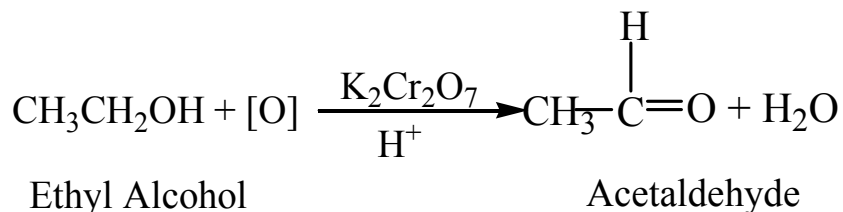
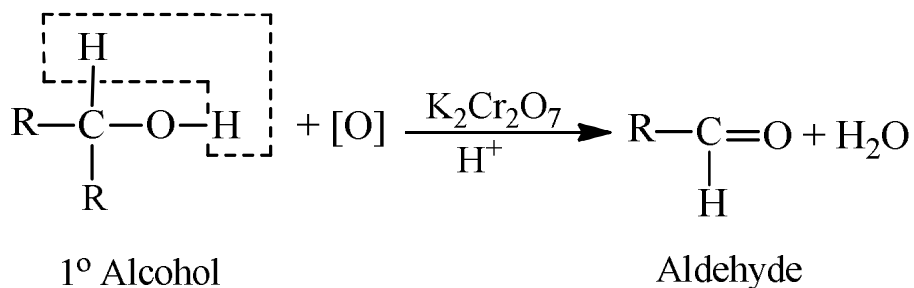

The aldehydes formed in the above reaction are very easily oxidised to carboxylic acid if allowed to remain in the reaction mixture.

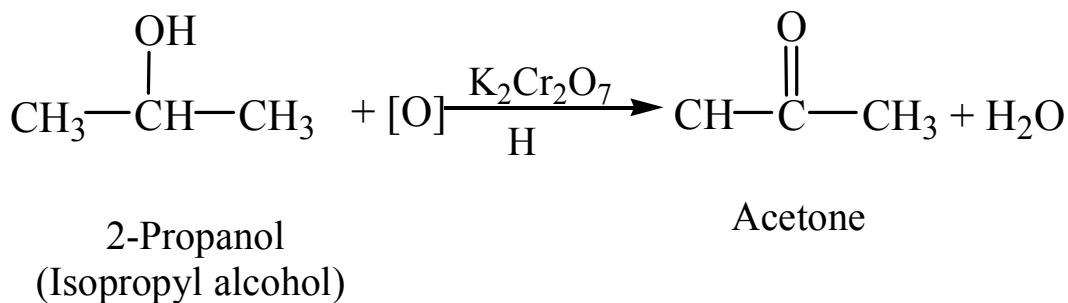
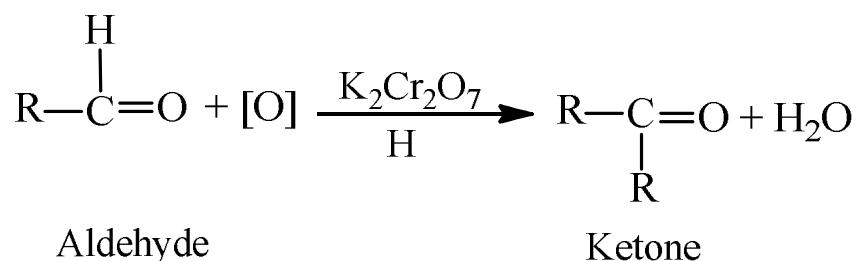

Ketones are not easily oxidised further and can be obtained in high yield by this method. Alternatively, ketones can be obtained from secondary alcohols through oxidation. In this process, the appropriate secondary alcohol is refluxed with an excess of acetone in the presence of aluminium tertiary-butoxide $\text{AlOC}(\text{CH}_3)_3$, catalyst

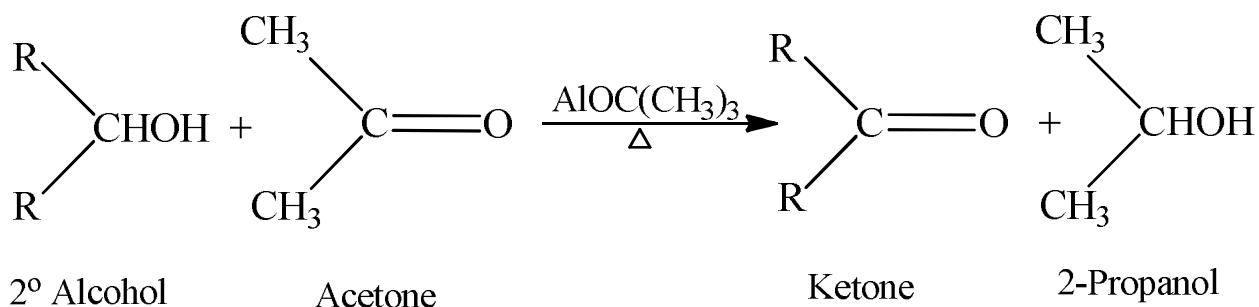

Catalytic dehydrogenation of alcohols: Aldehydes may be prepared by passing the vapours of primary alcohols over a copper catalyst heated to about 300 degree Celsius.

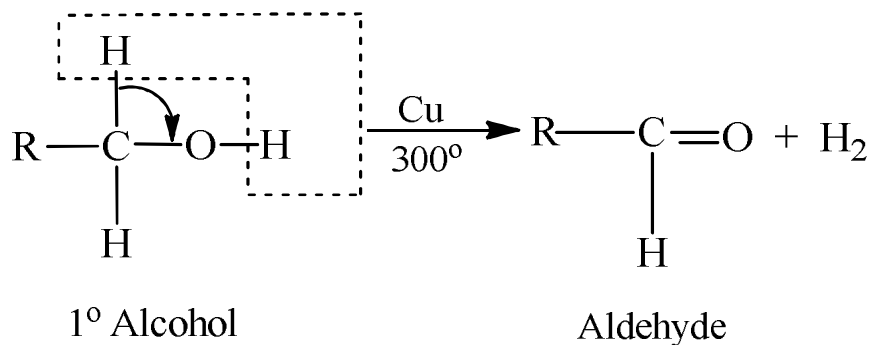

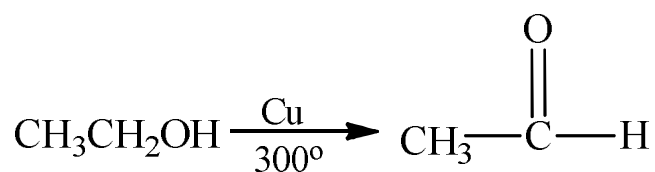

Ethyl Alcohol

Similarly ketones are produced from secondary alcohols.

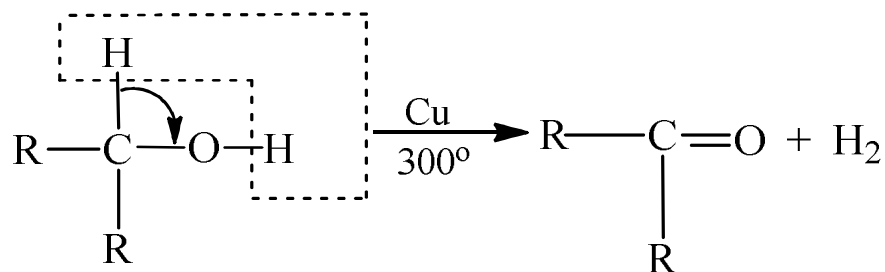

2° Alcohol

Ketone

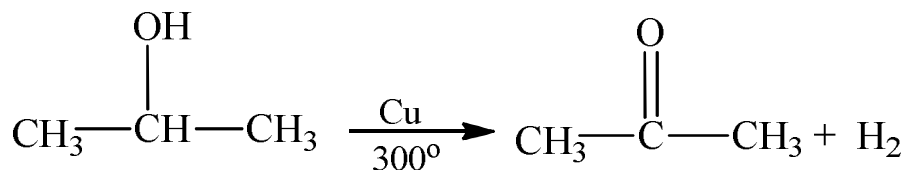

2-Propanol
(Isopropyl alcohol)

Acetone

(2) Oxidation of alkanes (Ozonolysis): Aldehydes and ketones can be obtained by ozonolysis of alkenes. This involves the treatment of the alkenes with Ozone to give ozonides, the ozonides are not isolated because they are often explosive in dry state. They are decomposed with Zn + H₂O to form aldehydes and ketones.

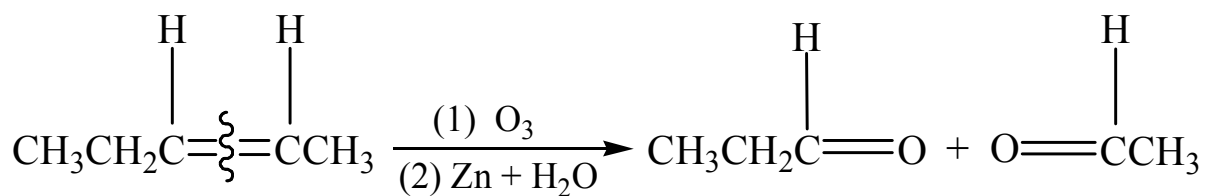

2-Pentene

Propionaldehyde

Acetaldehyde

Ozonolysis of alkenes is not a good preparative method for aldehydes and ketones. This is because a mixture of carbon and compounds is often produced. However if the starting alkene asymmetrical only one carbonyl compound will be obtained for example:

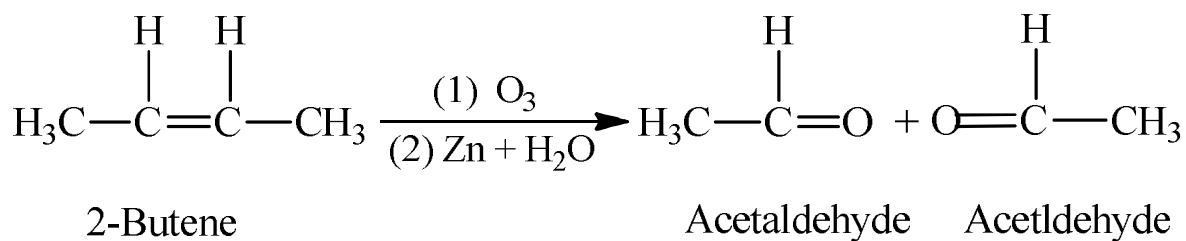

- (3) **Hydration of alkynes:** hydration of acetylene yields acetaldehyde. Water adds to acetylene in the presence of mercuric sulphate and sulfuric acid to form an unstable enol-intermediate. This intermediate rearranges to give acetaldehyde.

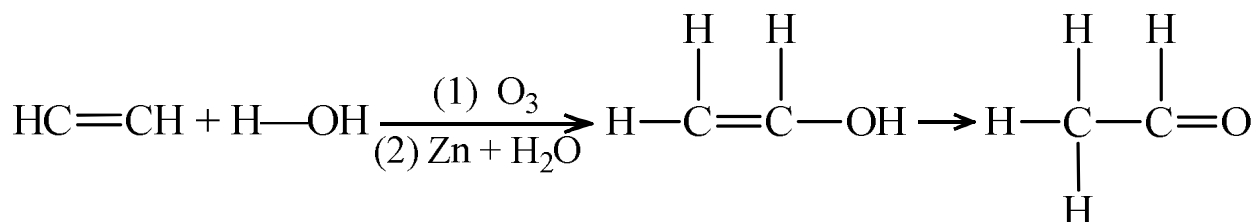

Hydration of alkynes, other than acetylene gives ketones. Water adds according to the Markovnikov rule to give an unstable enol-intermediate. This intermediate rearranges to form ketones.

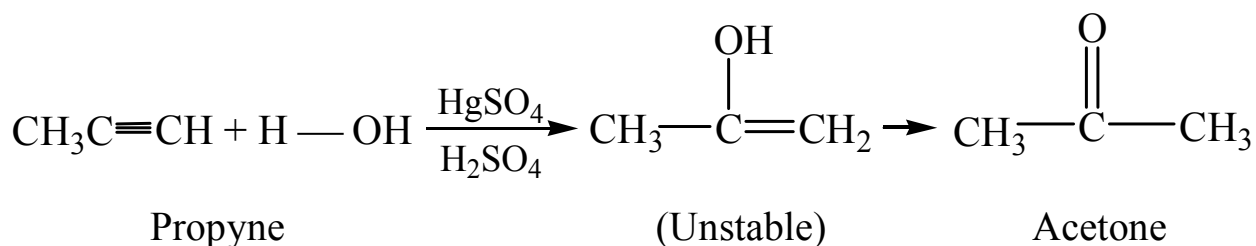

- (4) **Hydrolysis of gem-dihalides:** Gem-dihalide is a compound that has two halogen atoms attached to the same carbon.

Aldehydes are prepared by alkaline hydrolysis of those gem-dihalides in which the two halogen atoms are attached to the terminal carbon atom. For example,

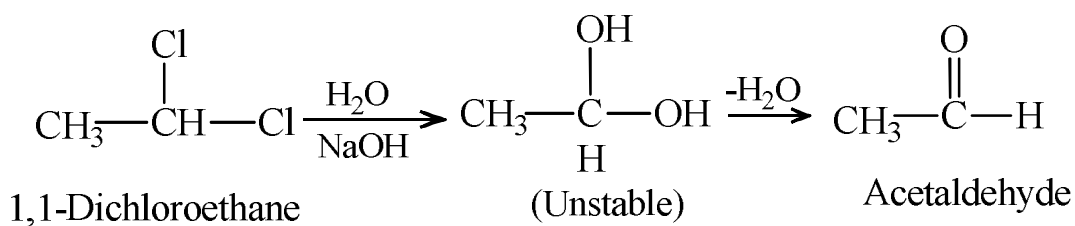

Ketones are produced by alkaline hydrolysis of these gem-dihalides in which the two halogen atoms are attached to a non terminal carbon atom. For example:

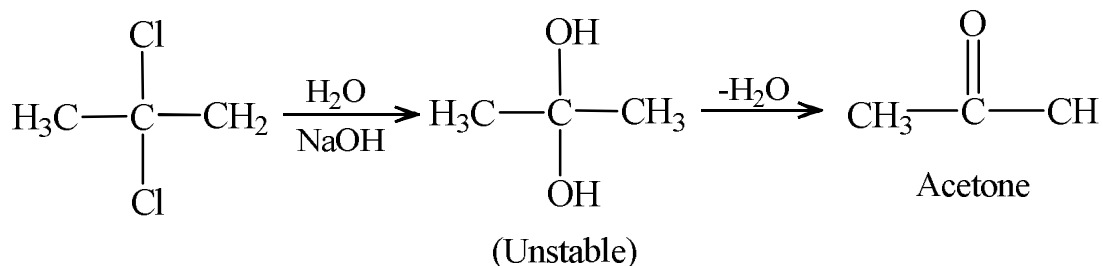

(5) Pyrolysis of calcium salts of acid: Symmetrical ketones may be prepared by heating calcium salt of acid at 400 degree Celsius. for example

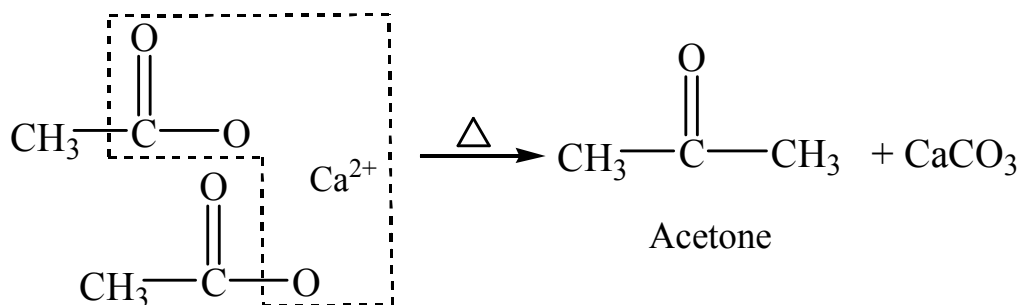

The calcium salt of acid is obtained by heating carboxylic acid with calcium oxide.

Aldehydes cannot be prepared by this method.

(6) Catalytic decomposition of acids: Symmetrical ketones can also be prepared by passing the vapours of a suitable carboxylic acid over heated MnO. For example

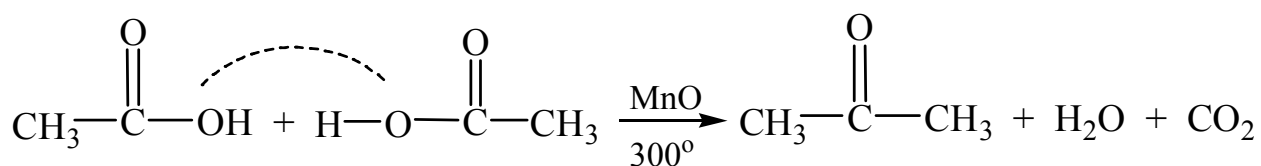

Two molecules of Acetic Acid

Aldehydes cannot be prepared by this method

- (7) **Reduction of acid chlorides:** Aldehydes can be prepared by the hydrogenation of acid chlorides in the presence of palladium supported over barium sulphate.

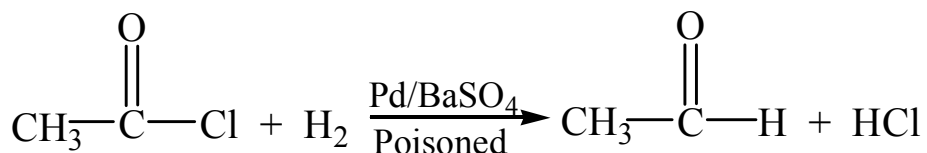
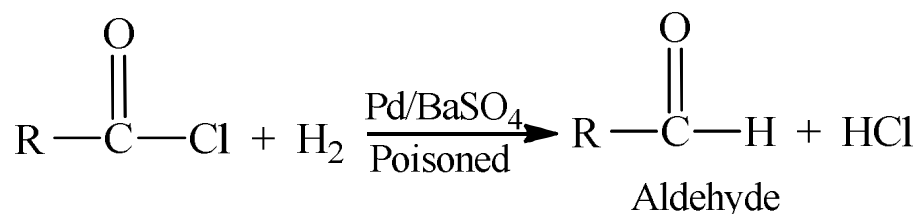

Acetylchloride

Acetaldehyde

Normally the aldehyde would be further reduced to a primary alcohol in this case the catalyst Pd/BaSO₄ is 'poisoned' with sulphur to deactivate it partially and prevent the reduction of the aldehyde to an alcohol. This reaction is called Rosenmund reduction.

Ketones cannot be prepared by this method

- (8) **Oxo process:** The oxo process is industrially important method for producing aldehydes. It involves that treatment of an alkene with carbon monoxide and hydrogen in the presence of cobalt carbonyl catalyst. High temperatures and pressures are used

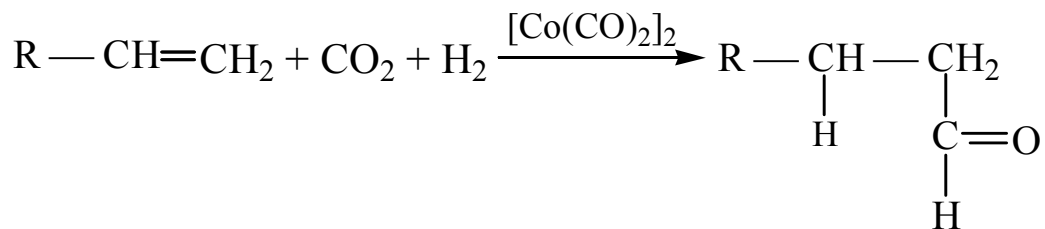

(9) **Wacker process:** Both aldehydes and ketones can be prepared by this method. This process involves the treatment of an alkene and acidified aqueous solution of Barium Chloride and cupric chloride for example.

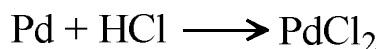
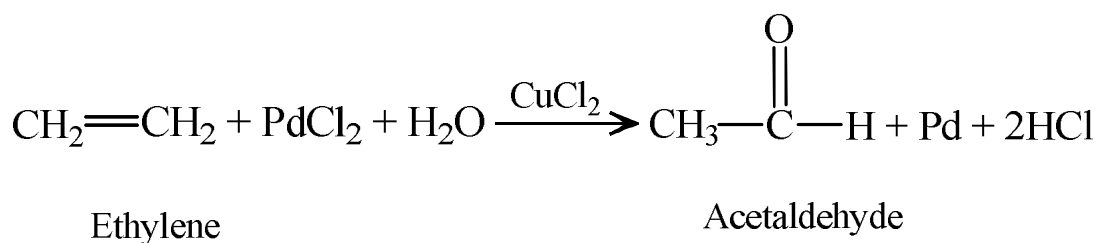

The cupric chloride promotes the second reaction enhancing the reconversion of the Palladium back into Palladium chloride

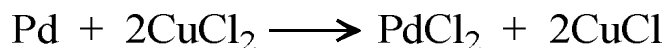

Acetone is prepared similarly from propene

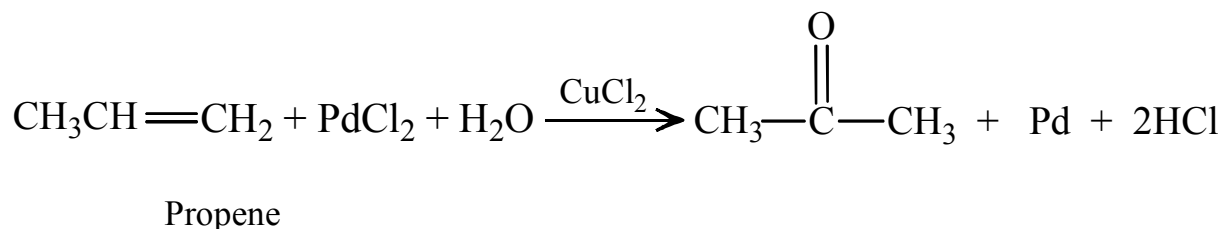

This method has been recently developed in Germany

4.5 Physical properties

- (1) Formaldehyde is a gas at room temperature. Acetaldehyde boils at 20°C other lower aldehydes and ketones are colourless liquids.
- (2) Lower aldehydes possess rather unpleasant, pungent smell whereas the ketones have pleasant sweet odors.
- (3) Density of aldehydes and ketones is less than of water.
- (4) Aldehydes and ketones are polar compounds. They have higher boiling points than alkanes and other nonpolar compounds of the same molecular weights. However since aldehydes

and ketones cannot form hydrogen bond with each other they have lower boiling points than the corresponding alcohols. The boiling points of some of the important aldehydes and ketones are given in Table 19.1

Table 19.4

Boiling Points of some Aldehydes and Ketones

Name	Formula	B.P° C
Aldehydes		
Formaldehyde	HCHO	-21
Acetaldehyde	CH ₃ CHO	20
Propinaldehyde	CH ₃ CH ₂ CHO	49
n-Butyraldehyde	CH ₃ CH ₂ CH ₂ CHO	76
Ketones		
Acetone	CH ₃ COCH ₃	56
Butanone	CH ₃ COCH ₂ CH ₃	80
2-Pentanone	CH ₃ COCH ₂ CH ₂ CH ₃	102
3-Pentanone	CH ₃ CH ₂ COCH ₂ CH ₃	101

- (5) Lower aldehydes and ketones are soluble in water. This is because of their ability to form hydrogen bonds with water molecules. Higher member containing more than five carbons are virtually insoluble in water.
- (6) **IR spectrum:** carbonyl groups of aldehydes and ketones give rise to a very strong so stretching bonds in the the 1665-1780 cm⁻¹ region of the infrared spectrum. The -CHO group of aldehydes also gives to weak bonds in the 2700-2775 and 2820- 2900 cm⁻¹ region of the infrared spectrum.

4.6 Chemical Properties

Nucleophilic addition reactions: Two carbonyl group of aldehydes and ketones is a highly polar group. It may be represented

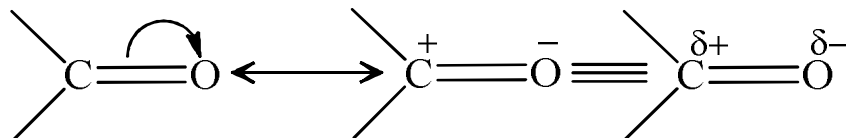

The positively charged is readily attacked by electron by electron rich electrophiles. The negatively charged oxygen is attacked by electron deficient electrophiles.

Aldehydes and ketones undergo nucleophilic addition reaction by the following general mechanism.

Step 1: The nucleophile (Nu) attacks the positively charged carbonyl carbon to form a new bond. As the new bond is formed pi bond between the carbon and oxygen is broken. The electron pair goes to oxygen which requires a negative charge.

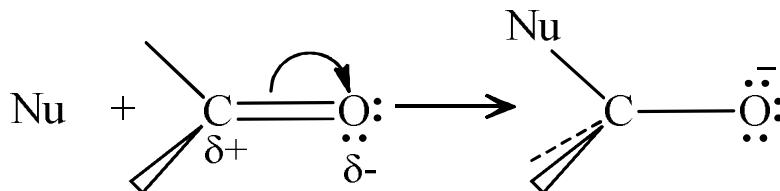

Step 2: The electrophile (e.g., H⁺) Attacks the negatively charged oxygen to form the addition product.

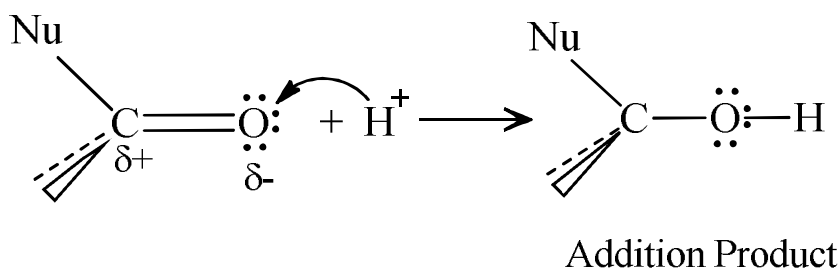

The nucleophilic addition reaction of carbonyl compounds maybe catalysed by acids or bases.

Base-Catalysed Addition: Bases convert a weak natural nucleophile to a strong one by removing a Proton. The strong nucleophile then adds to the carbonyl group as shown above.

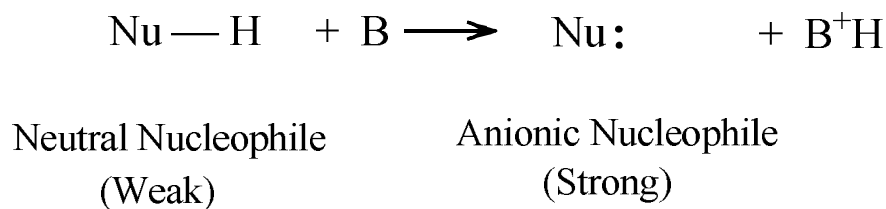

Acid catalysed addition: The acid catalysed nucleophilic addition occurs by the following mechanism:

Step 1: The hydrogen ion formed the acid attacks the negatively charged carbon and oxygen to give protonated carbonyl group. This protonated carbonyl group is resonance stabilized.

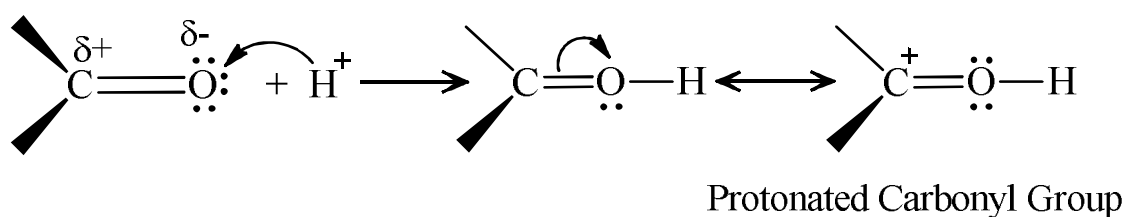

Step 2: The nucleophile attacks the protonated carbonyl group to form the addition product.

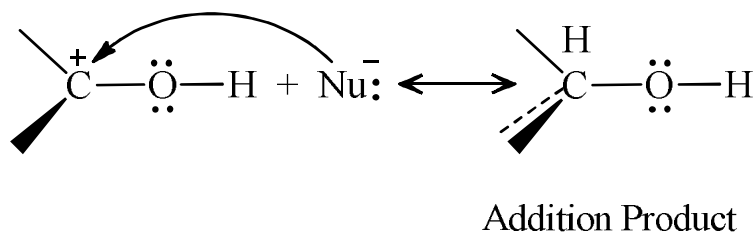

Notice that the addition product is the same whether the reaction is acid catalyzed or base catalysed. The nucleophile always adds to the carbonyl carbon and the proton (electrophile), to the oxygen. Generally ketones are less reactive than aldehydes in nucleophilic addition reaction.

Acidity of Hydrogens: A carbon atom next to the carbonyl group is called an α -carbon. Hydrogen attached to α -carbon is referred to as α -hydrogen. The α -hydrogen of aldehydes and ketones are acidic in nature. The acidity is due to the fact that the anion which results from the removal of α -hydrogen by a base, beta negative is stabilized by resonance.

The resonance stabilized ion is called enolate ion.

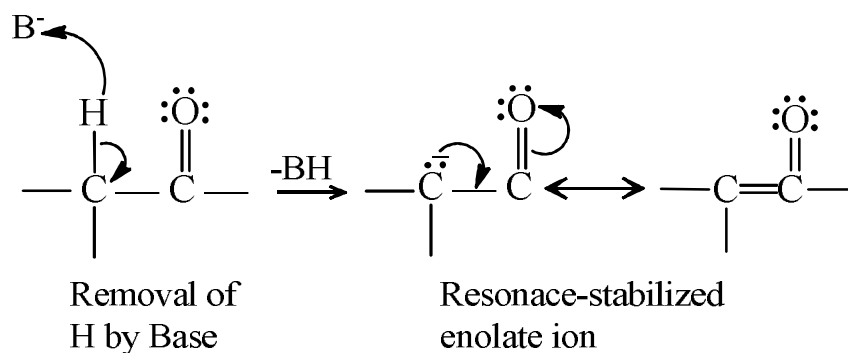

The α -carbon of the enolate ion is negatively charged. It can act as a nucleophile. The formation of the enolate ion followed by its addition to a carbonyl group is the process involved in all the condensation reactions of aldehydes and ketones.

Some of the important reactions of aldehydes are described below:

4.7 Addition Reactions

- (1) **Addition of sodium bisulfite:** Aldehydes and methyl ketones react with the saturated aqua solution of sodium disulfite (NaHSO_3) to form solid addition compounds.

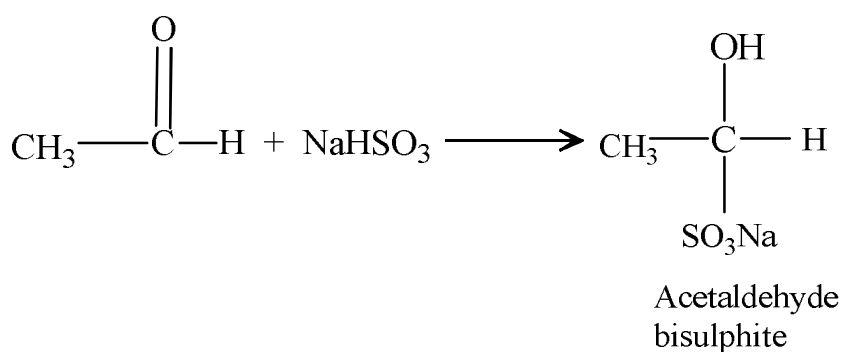
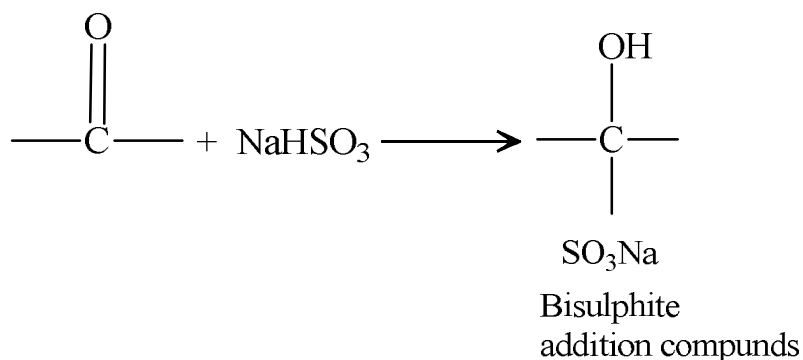

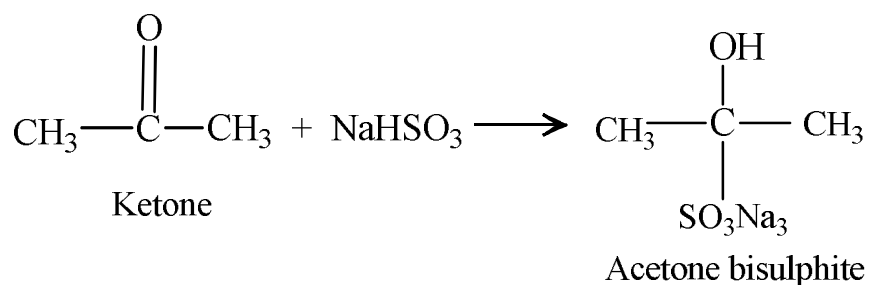

The bisulfite addition compounds can be decomposed with dilute acids or bases to regenerate the carbonyl compound. For example

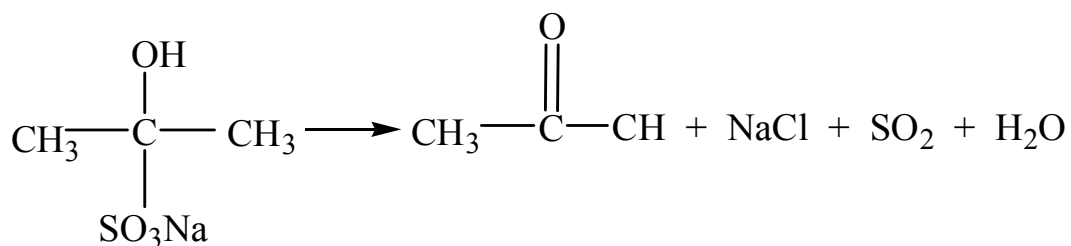

Therefore, the formation and decomposition of bisulfite addition compounds is used for the separation of carbonyl compounds from mixtures.

(2) Addition of hydrogen cyanide: aldehydes and ketones react with hydrogen cyanide to form cyanohydrin. this reaction is carried in the presence of the basic catalyst

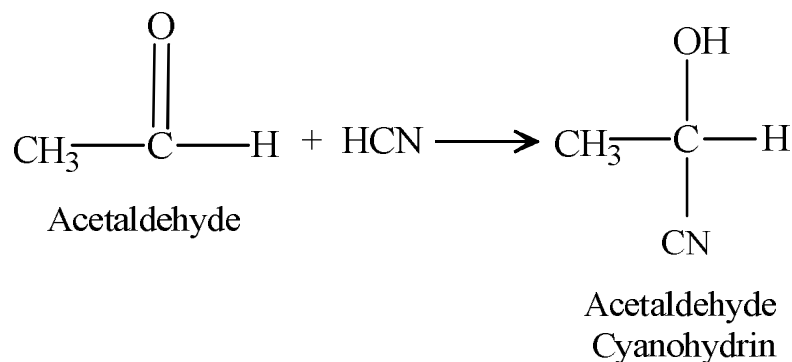
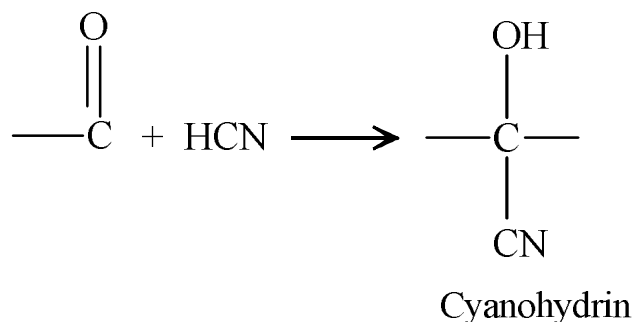

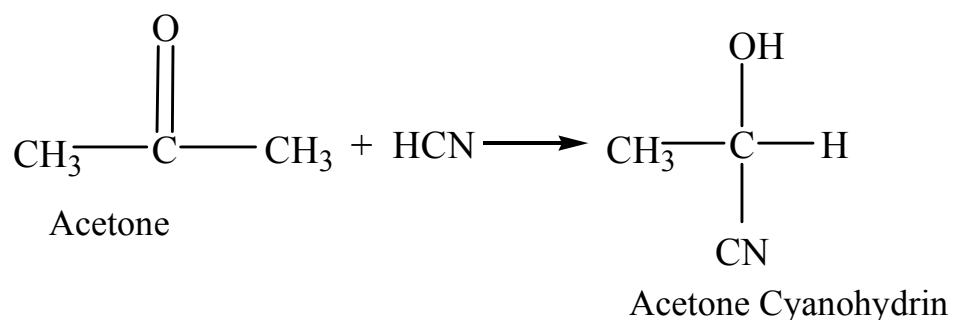

HCN is a very poisonous gas. It is produced in situ by the action of dilute sulphuric acid on potassium cyanide.

Mechanism: The mechanism involves the following steps:

Step-1:

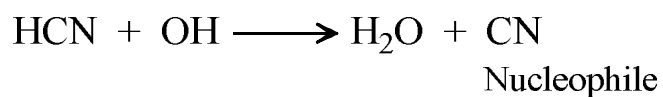

Step-2: This cyanide ion attacks the carbonyl carbon to form an anion.

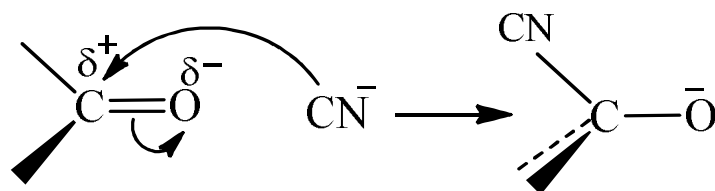

Step-3: The proton from the solvent (usually water) combines with the anion to give cyanohydrin.

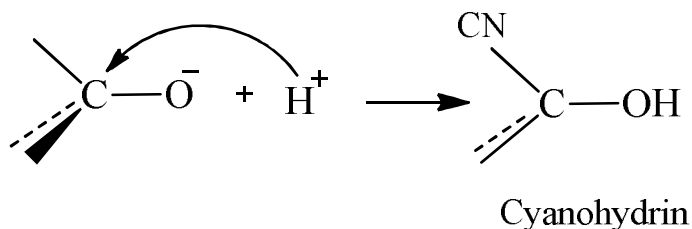

Like other nitriles, cyanohydrin can be hydrolysed to give α -hydroxy carboxylic acid.

For example.

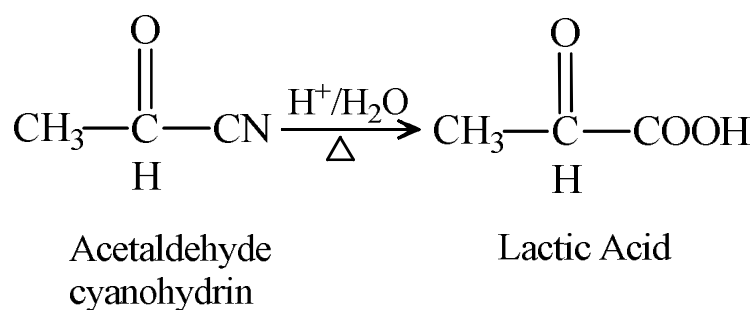

(3) **Addition of Grignard reagents:** Aldehydes and ketones react with Grignard reagents to give products which can be hydrolysed with dilute acid to give alcohol

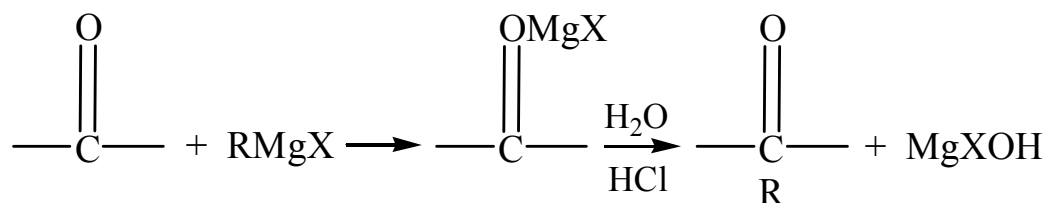

The reaction provides a convenient way of preparing alcohols that contain a large carbon chain than the starting materials is. Formaldehyde reacts with Grignard reagents to produce primary alcohols. Other aldehydes give secondary alcohols, ketones react with Grignard reagents to produce tertiary alcohols for example:

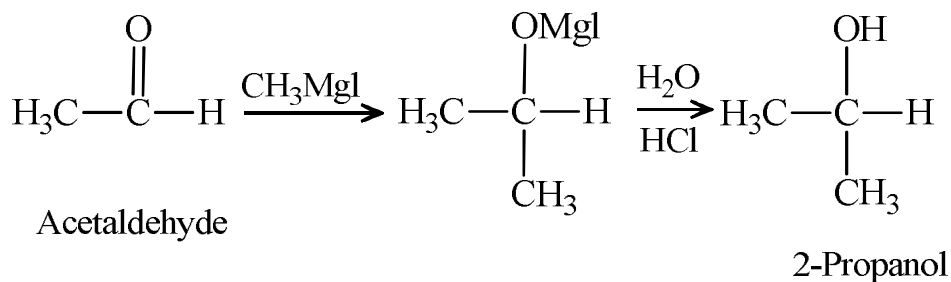
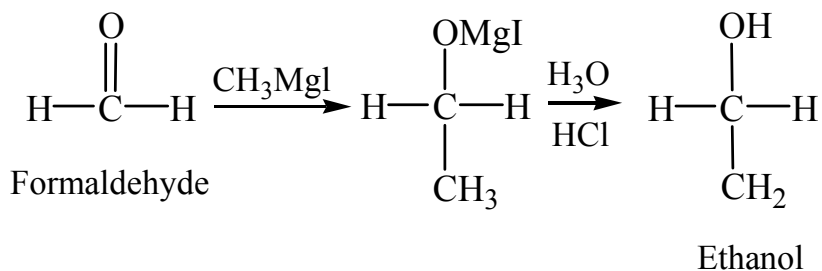

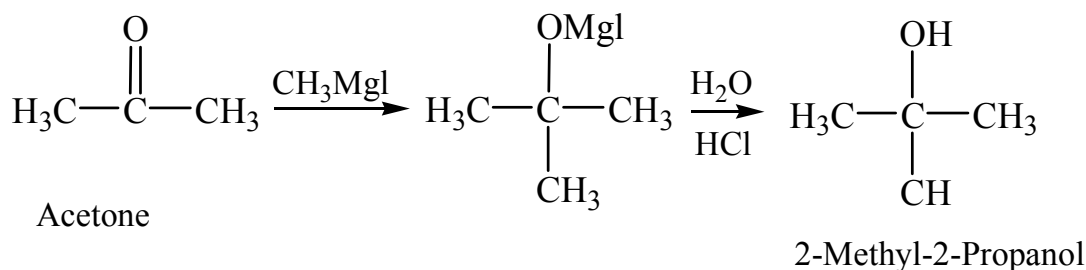

(4) Addition of ammonia: Aldehydes (except) formaldehyde reacts with ammonia to form solid aldehydes ammonia to form solid. For example

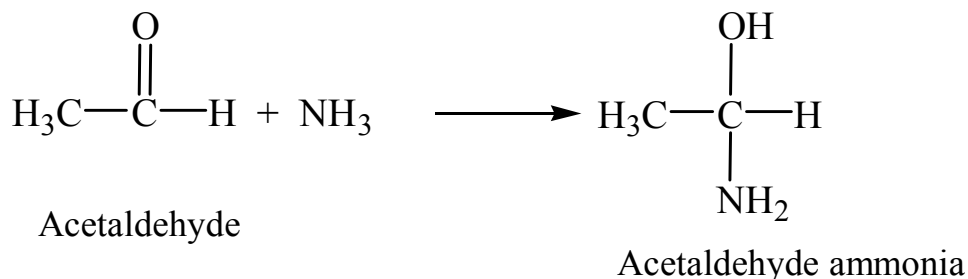

Aldehyde Ammonia as when heated with dilute acids re-generates the aldehyde. Thus the formation and decomposition of the compounds is used for purification of aldehydes. Formaldehyde and ketones do not form addition compounds with ammonia, but yield complete condensation products. For example

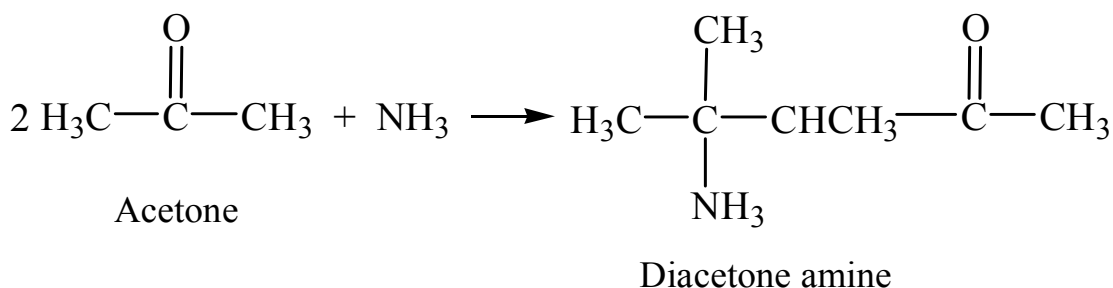

B. Addition reactions followed by loss of water

(5) Addition of alcohol: Alcohols react with aldehydes in the presence of anhydrous HCl from unstable addition products known as Hemiacetals. These hemiacetals react further with alcohols to form stable compounds known as acetals. Notice that the acids are gem diethers.

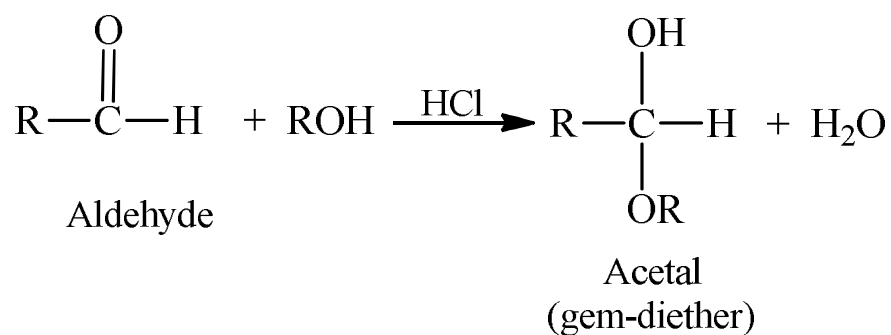

The reaction is reversible. a large excess of alcohol is used to shift the equilibrium in favour of acetal formation. The reaction of acetaldehyde with methyl alcohol result in the formation of acetaldehyde dimethyl acetal

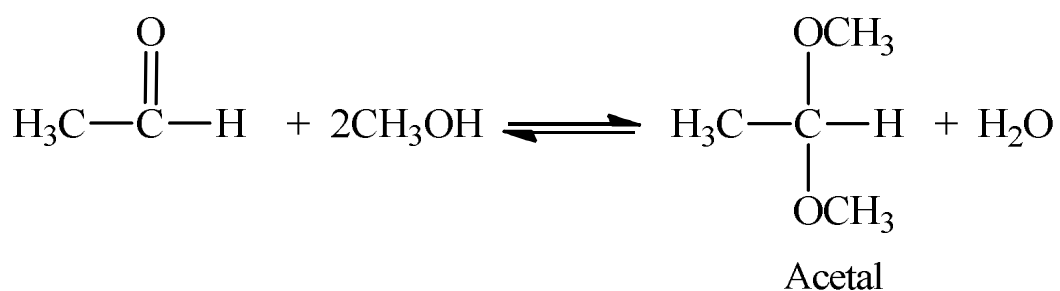

Ketones do not react with alcohols to form the corresponding Hemiketals and Ketals.

- C. **Reaction with Ammonia derivatives:** Some ammonia derivatives (NH_2Z) react with aldehydes and ketones to form compounds containing carbon nitrogen double and Alpha bonds together with the elimination of water molecules.

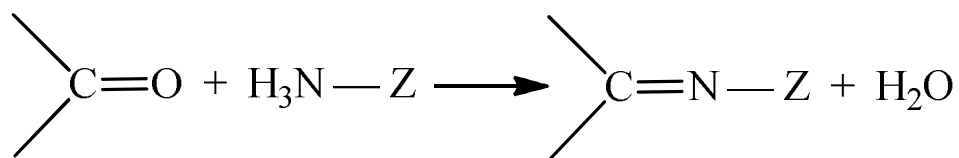

The reaction products are usually crystalline solids, their melting points can be used to identify aldehydes and ketones, most of which are liquids.

Step 1: Ammonia derivatives (NH_2Z) behave as nucleophilic points Reagents. Since they have earned unshared electron pair on nitrogen. They are added to the carbonyl group in aldehydes and ketones

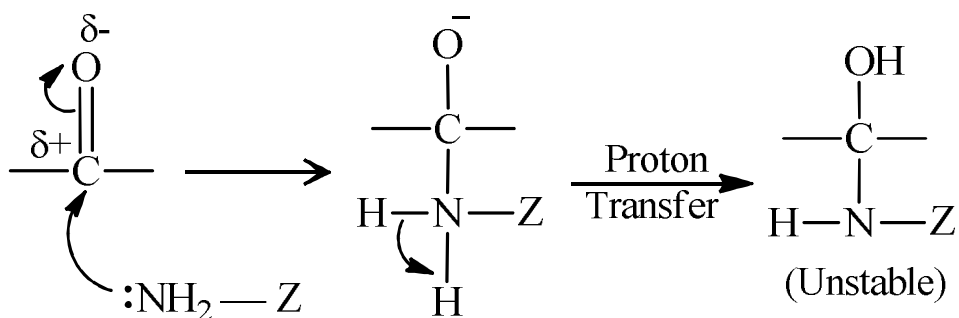

Step 2: This addition product rapidly loses a molecule of water to give final product.

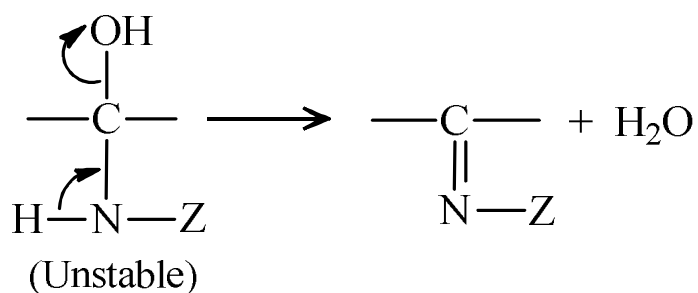

The ammonia derivatives which react in this way are: hydroxylamine, hydrazine, phenylhydrazine, 2,4- dinitrophenylhydrazine, semicarbazide

(a) Reaction with hydroxylamine: Aldehydes and ketones react with hydroxylamine (NH_3OH) to form oximes For eg:

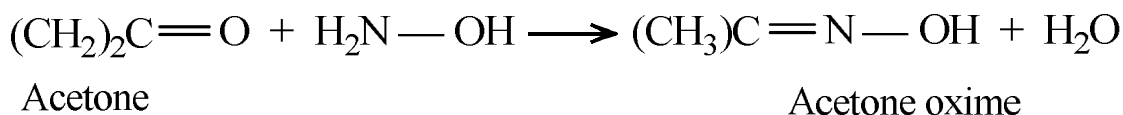
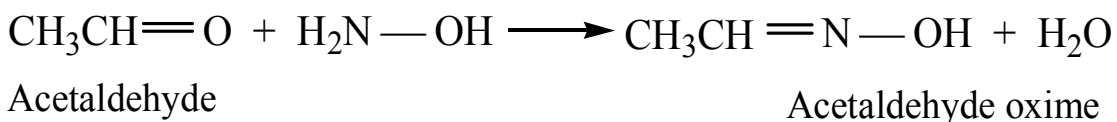

(b) Reaction with hydrazine: Aldehydes and ketones react with hydrazine (NH_2NH_2) to form hydrazones. For example:

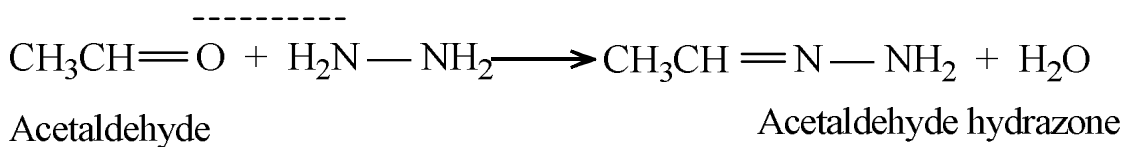

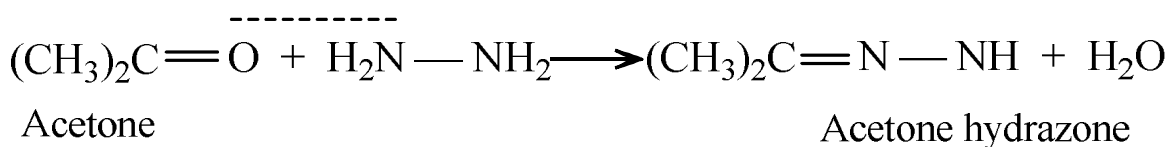

(c) **Reaction with phenylhydrazine:** Aldehydes and ketones react with phenylhydrazine ($\text{NH}_2\text{NHC}_6\text{H}_5$) to form phenylhydrazone. For example:

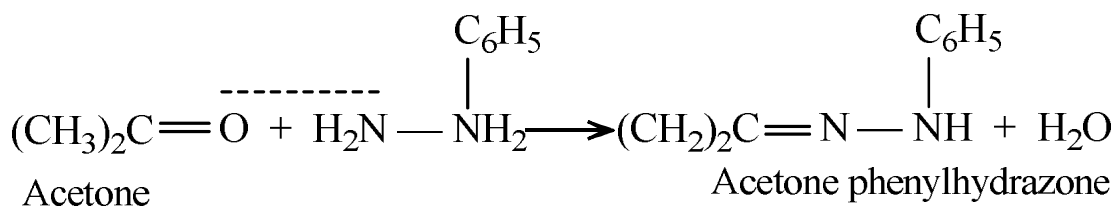
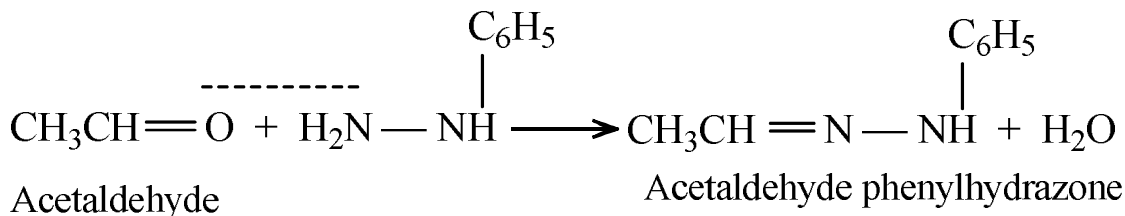

(d) **Reaction with 2,4- dinitrophenylhydrazine:** Aldehydes and ketones react with 2,4- dinitrophenylhydrazine to form dinitrophenylhydrazones. For example:

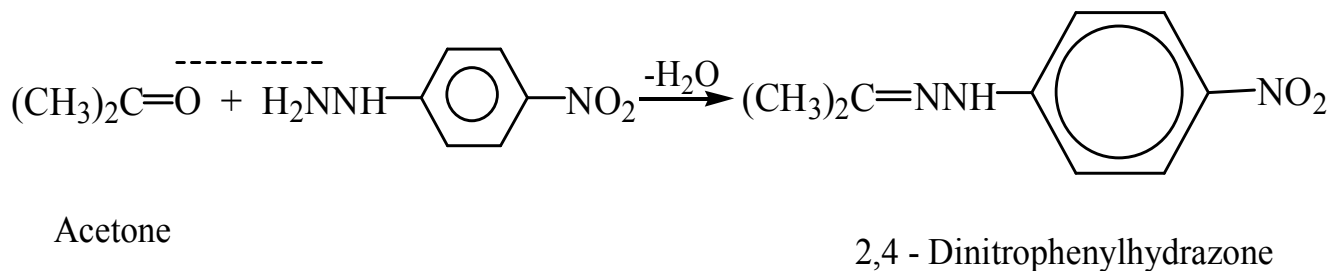

(e) **Reaction with Semicarbazide:** aldehydes and ketones react with semicarbazide to form semicarbazones. For example:

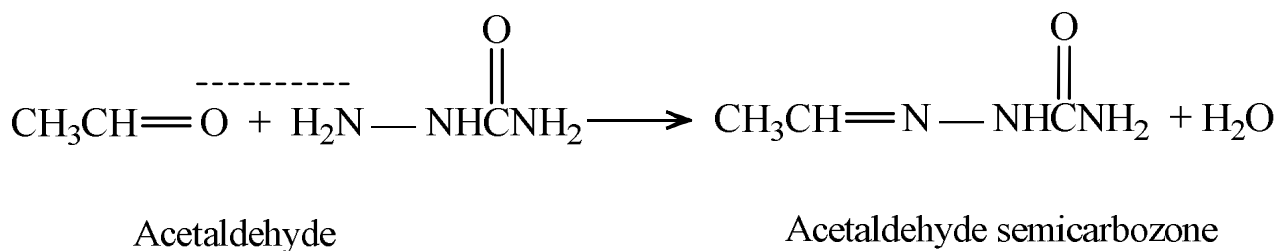

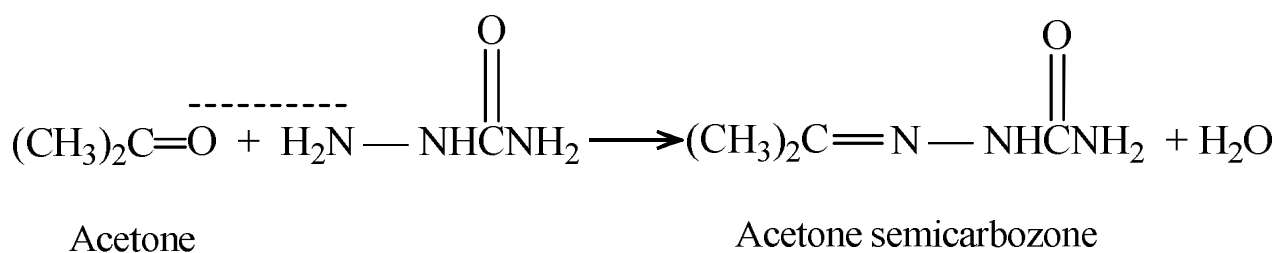

D. Reactions Involving Alkyl Groups

(6) **Aldol condensation:** aldehyde containing hydrogen undergoes self addition in the presence of a base to form products called Aldols. The reaction is called aldol condensation. The term aldol is derived from the combination of the word aldehyde and alcohol the two functional groups present in the products. For example two molecules of acetaldehyde combine with each other in the presence of dilute NaOH to form 3 hydroxybutanal.

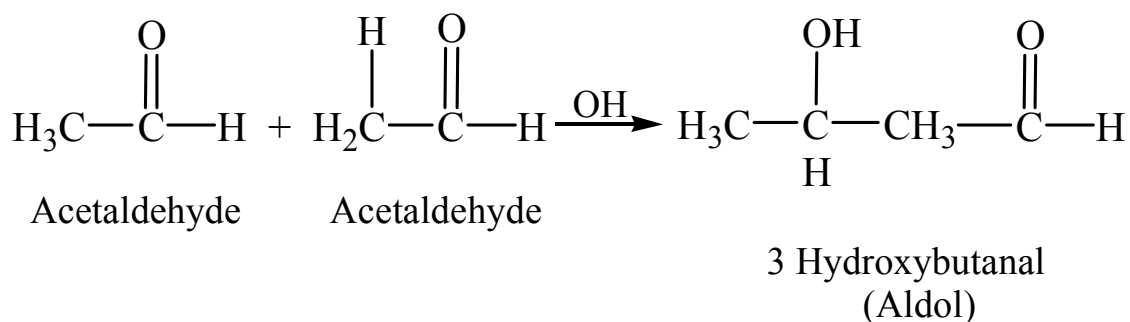

Mechanism: the reaction is reversible and involves the following steps:

Step-1: The enolate ion is formed

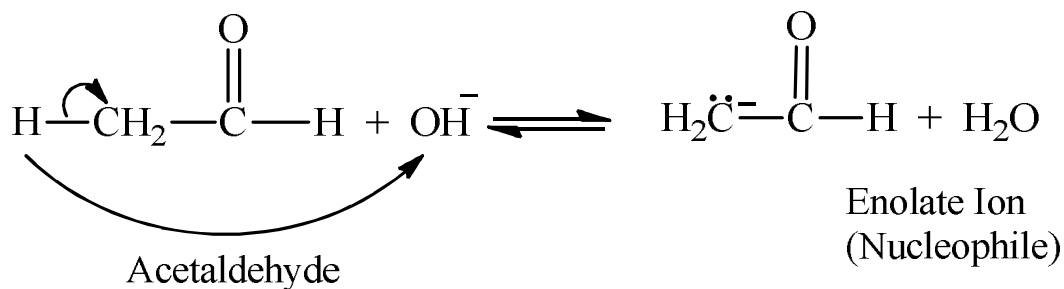

Step 2: The enolate Ion attacks the carbonyl carbon of other and ionized aldehyde molecule.

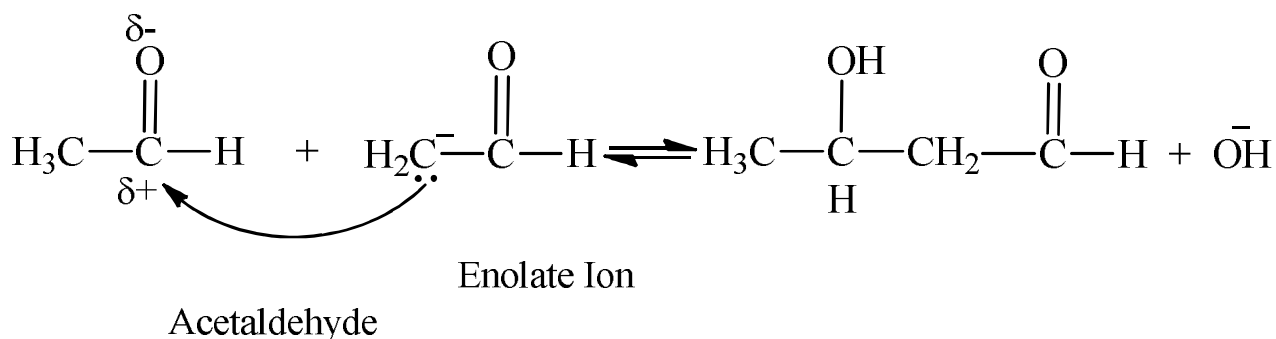

Step 3: The negative oxygen in the product accepts a proton from water to give aldol.

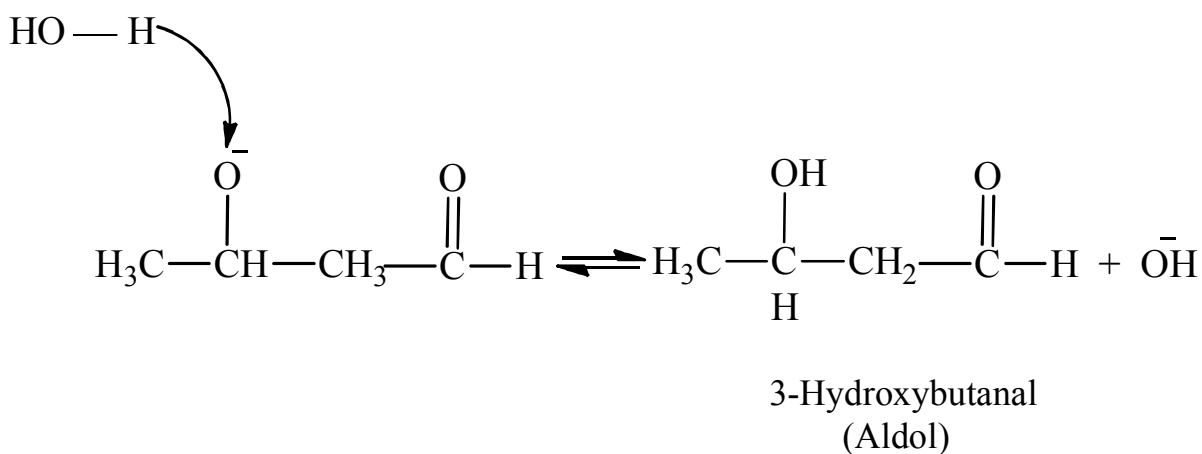

Aldols are easily dehydrated either by heating or by treatment with dilute acid to form a β -unsaturated aldehydes. For example:

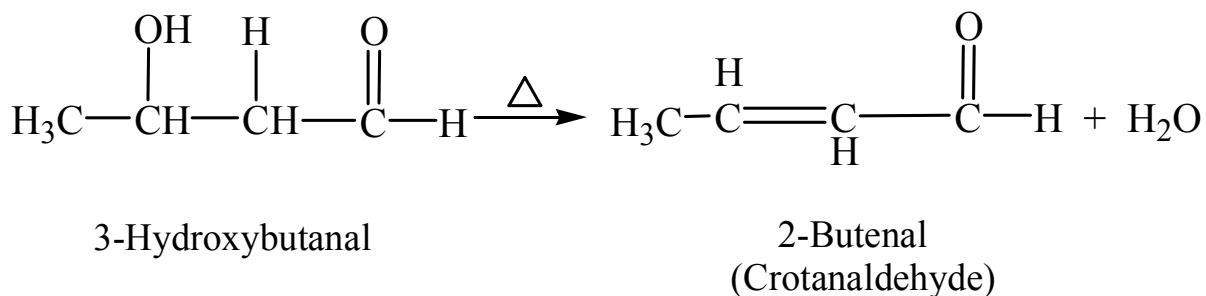

Ketones containing hydrogen also undergoes aldol condensation to form ketones for example, two molecules of acetone combine with each other in the presence of Barium Hydroxide to form 4-hydroxy-4-methyl-1,2-pentanone (diacetone alcohol)

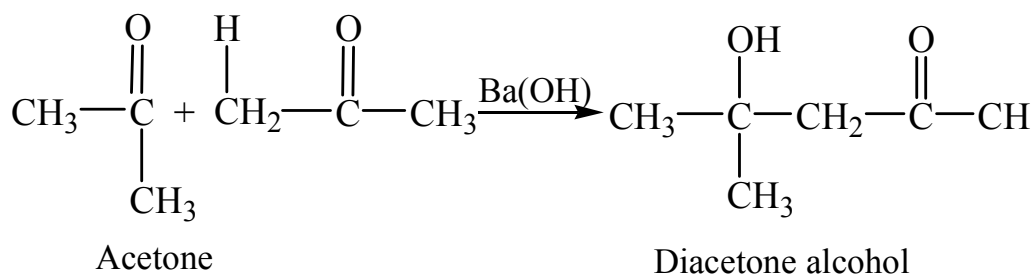

Ketones are also usually dehydrated by heating or by treatment with dilute acid to form an α,β -unsaturated ketone. For example:

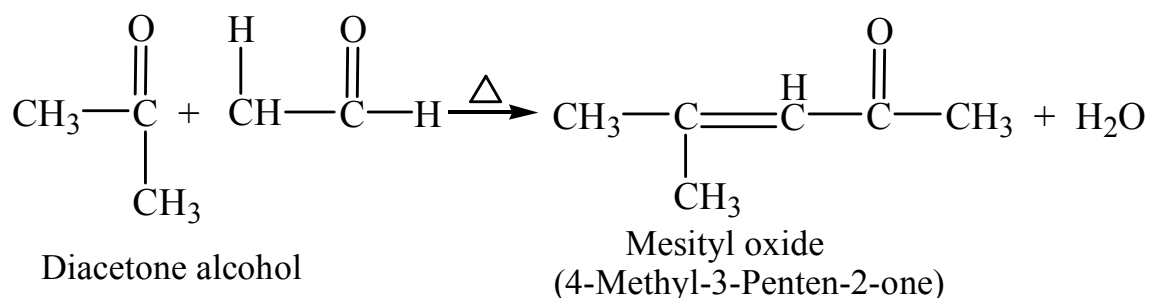

Mixed Aldol condensation: The reaction of two different carbonyl compounds (one of which has α -H) in the presence of a base is known as mixed aldol condensation. For example, acetaldehyde reacts with benzaldehyde (which has no α -H) in the presence of a base to form cinnamaldehyde.

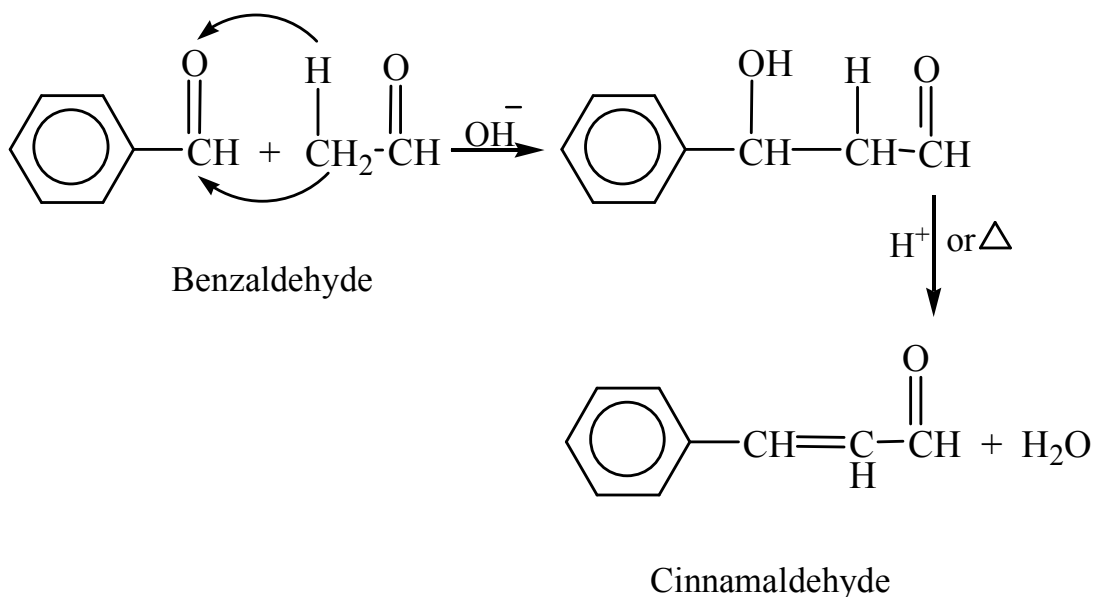

(7) **Chlorination:** Under suitable conditions, chlorine will successfully replace the α -hydrogen in aldehydes and ketones. For example, when chlorine is bubbled through acetaldehyde, chloral (Trichloroethanal) is obtained.

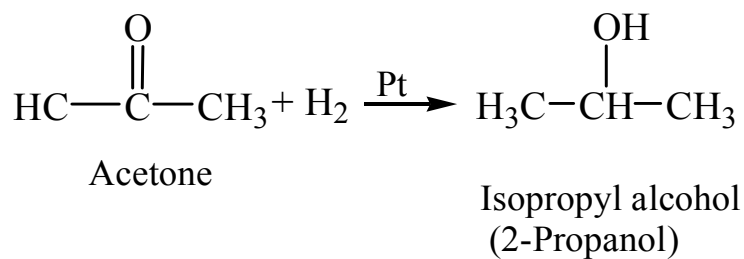

Some results can be achieved with chemical reducing agents such as Lithium aluminium hydride (LiAlH₄) or sodium Borohydride (NaBH₄). For Example

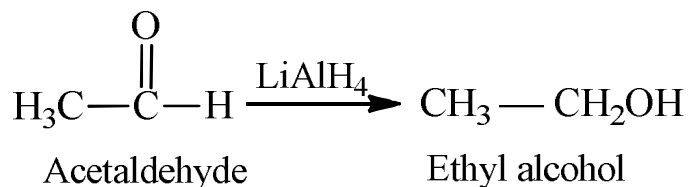

(9) Reduction to Alkane: aldehydes and ketones can be reduced to alkanes by either the Clemmensen reduction or the Wolf-kishner reduction.

Clemmenson reduction: This involves the use of zinc, mercury amalgam in hydrochloric acid as a reducing agent.

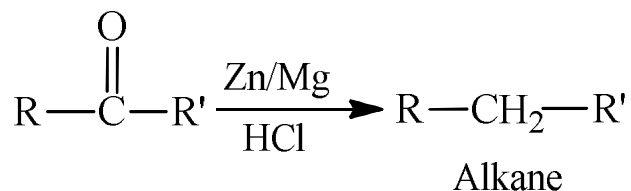

(10) Reduction to pinacols: Ketones when reduced in neutral or alkaline medium, form pinacols (symmetrical 1,2- diols). For example Acetone undergoes reduction with magnesium amalgam to form 2,3-dimethylbutane -2,3 diol.

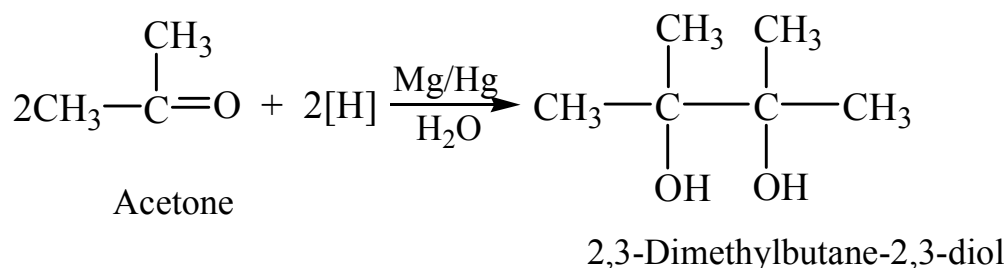

Aldehydes do not give this reaction.

F. Oxidation reaction

Although the chemical reactivity of aldehyde and ketones is very similar, their behaviour towards oxidizing agents is quite different. Aldehyde are easily oxidised, ketones are oxidised only under drastic conditions.

(11) Oxidation of aldehyde: Aldehydes can be oxidised with sodium (or potassium) dichromate in acidic medium to form carboxylic acids containing the same number of carbon atoms.

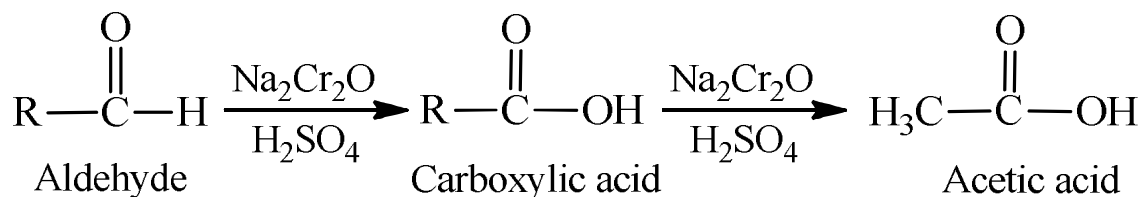

Potassium permanganate can also be used in place of sodium dichromate aldehydes can be oxidised by much milder oxidizing agents such as Tollens Fehlings solution and Benedict's solution.

Tollens reagent: Tollens reagent is ammoniacal solution of silver nitrate. It is obtained by adding Ammonia to a precipitate of silver oxide present in a solution of silver nitrate and sodium hydroxide. When Tollens reagent is used to oxidize an aldehyde the Silver ion is reduced to metallic form and if the reaction is carried out in a clean test tube deposit as a mirror. The silver mirror formed indicates the presence of an aldehyde group in a molecule.

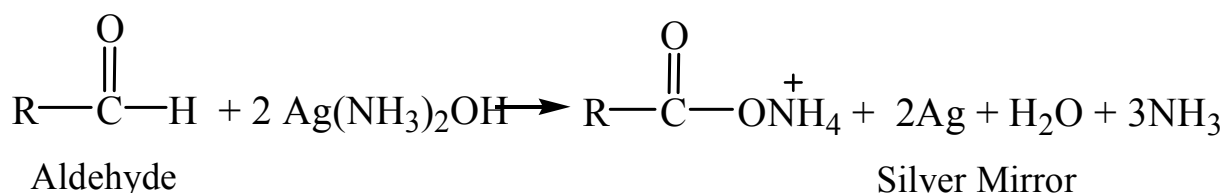

Fehling solution: Fehling's solution is an alkaline solution of cupric ion complexed with sodium potassium tartrate ions. When Fehling solution is used to oxidise an aldehyde, the complex cupric ion (deep blue) is reduced to cuprous oxide (red). The presence of the red precipitate of cuprous oxide serves as an indication of an aldehyde group in a molecule.

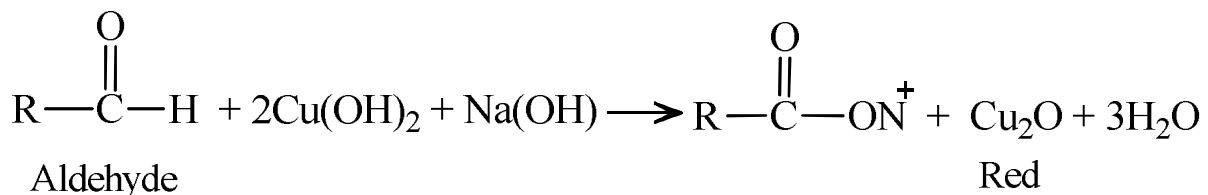

Benedict's solution: it is an alkaline solution of cupric ion complexed with citrate ions. It reacts in the KMnO₄ or hot same ways as Fehling solution.

(12) Oxidation of ketones: Ketones can be oxidised by strong oxidizing agents such as alkaline KMnO₄ and hot concentrated HNO₃ to form carboxylic acids with fewer carbon atoms than the original ketone this is because the ketone is broken into two fragments by attack on either side of the carbonyl groups.

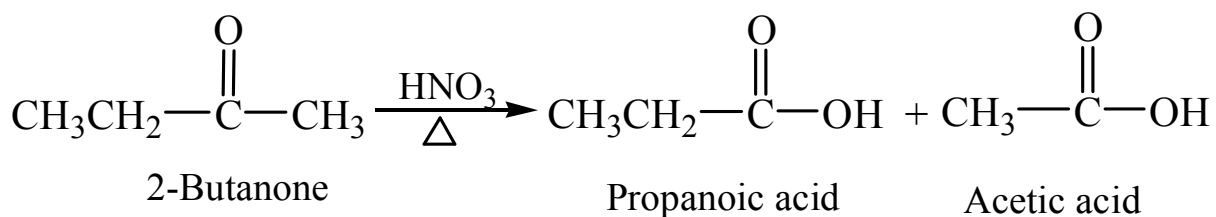
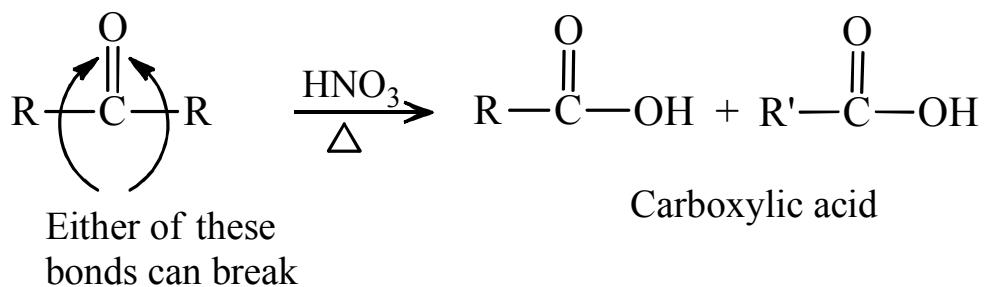

Ketones do not react with Tollens reagent, Fehling's solution or Benedict's solution.

F. Some other important reactions

(13) Haloform reactions: Acetaldehyde and methyl ketone react rapidly with halogen (Cl₂, Br₂ or I₂ in the presence of alkali to form haloform. For Example

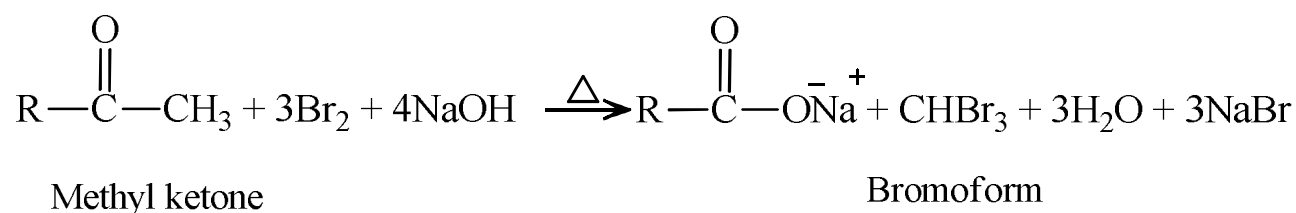

Reactions called the Haloform reaction, takes place in two steps:

Step 1: Three hydrogen atoms on the Alpha carbon are successively replaced by halogen atom.

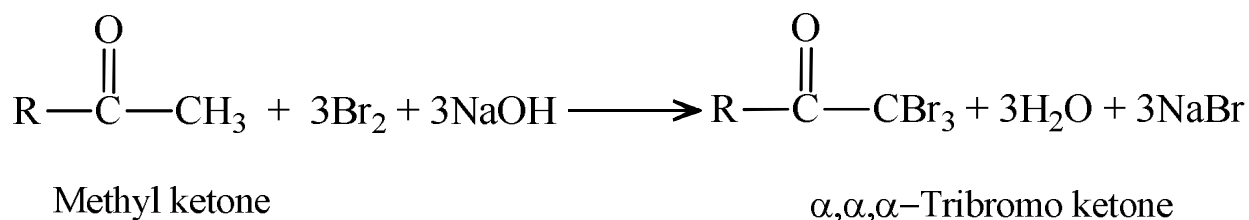

Step 2: To the α,α,α -tri haloketone molecule is cleaved to give trihalomethane.

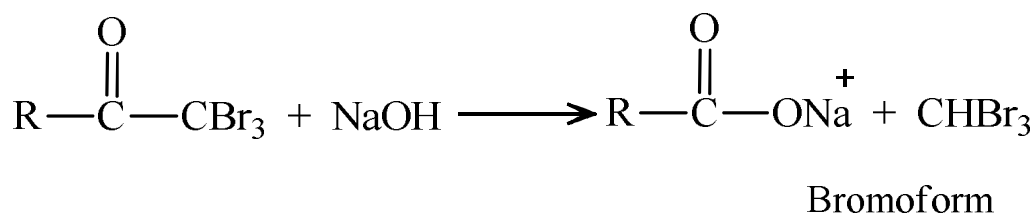

The haloform reaction is used as a Diagnostic test for the presence of $-\text{COCH}_3$ of group. For this purpose a solution of iodine is added to an unknown compound in an aqueous alkali solution. A positive test will yield a bright yellow precipitate of iodoform (chloroform and bromoform are liquids). This is known as iodoform test and is converted to acetaldehyde and secondary alcohols are converted to methyl ketones under the conditions used for the test.

The haloform reaction can also be used to distinguish methyl ketones from other ketones. For example:

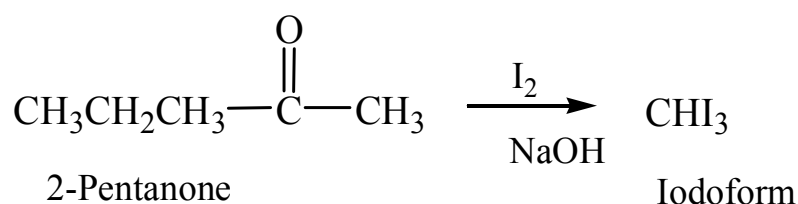

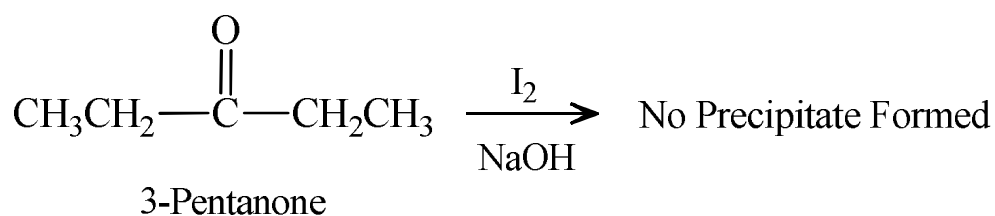

(14) Cannizzaro reaction: Aldehydes which lack a α -hydrogen, when treated with NaOH undergo a disproportionation reaction. One half of the aldehyde molecules are oxidized to a carboxylic acid and one half are reduced to an alcohol. This reaction is known as Cannizzaro Reaction (remember: aldehydes with α -hydrogen do not undergo this reaction. Under these conditions they undergo aldol condensation reaction. For example:

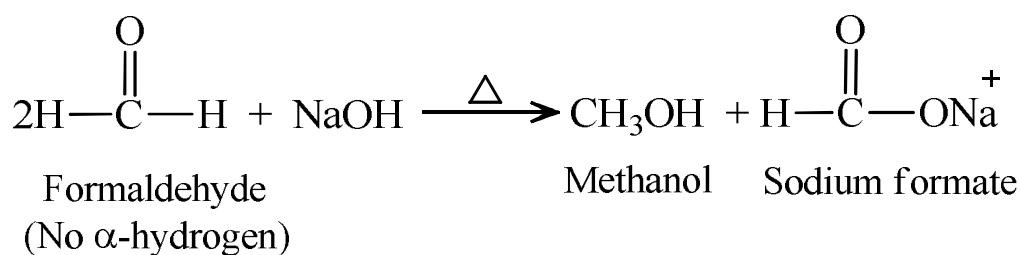

Mechanism: Two Steps are involved:

Step 1: Attack of the HO^- on the carbonyl group.

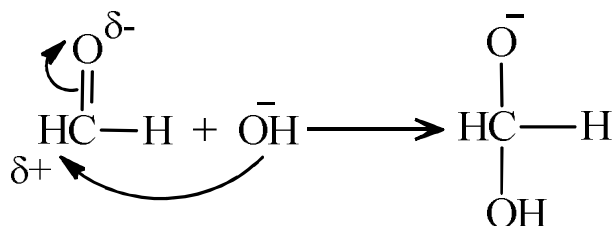

Step 2 Hydride transfer.

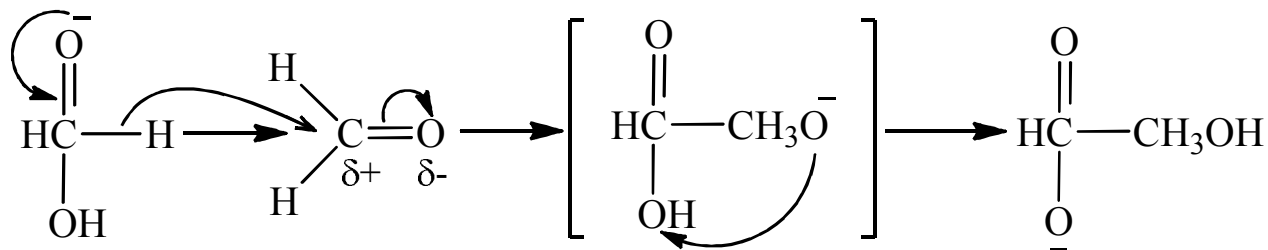

(15) Reformatsky Reaction: This involves the treatment of an aldehyde or Ketone with α -bromo ester in the presence of zinc. The product after acid (hydrolysis) is a δ -hydroxy ester for example. For Example:

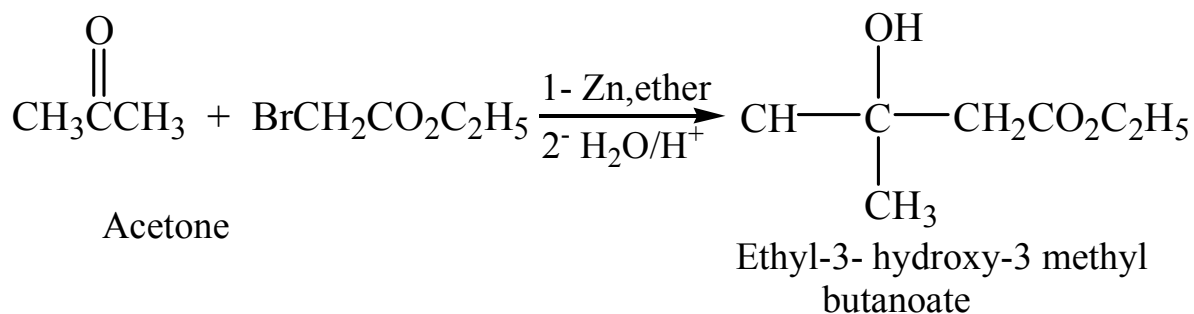

Mechanism: Three-steps are involved:

Step 1: Formation of zinc salt of end of the ester

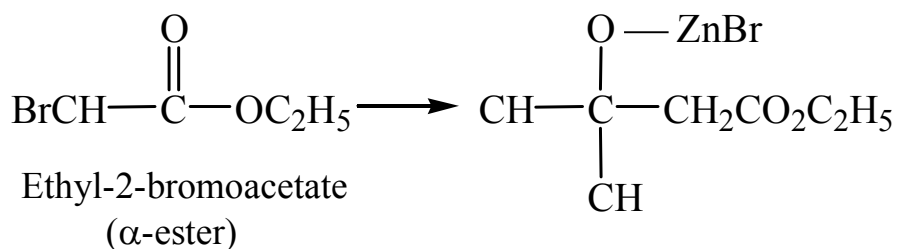

Step 2: The zinc salt reacts with carbonyl compounds.

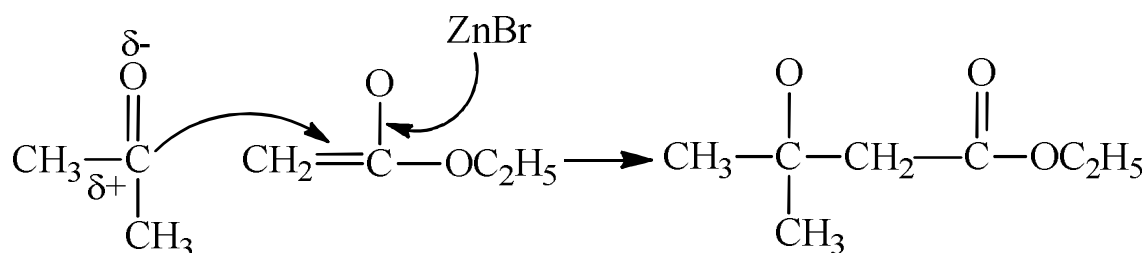

Step 3: acid hydrolysis gives the β -hydroxy Ester.

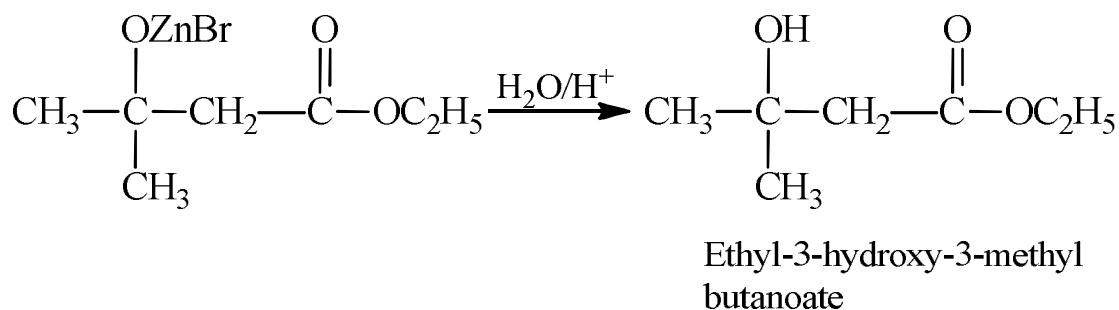

(16) **Witting's Reaction:** this involves the treatment of aldehydes and ketones which phosphorus ylides to form alkenes.

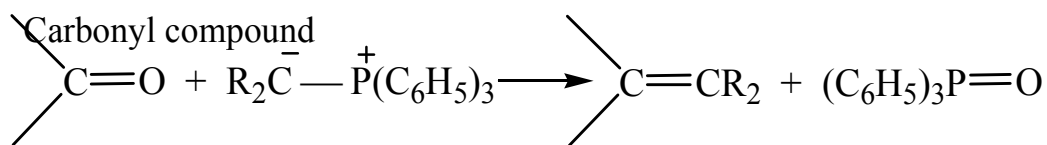

An ylide it is a molecule with adjacent opposite charges. Phosphorus ylides are prepared from primary alkyl halides and triphenylphosphine.

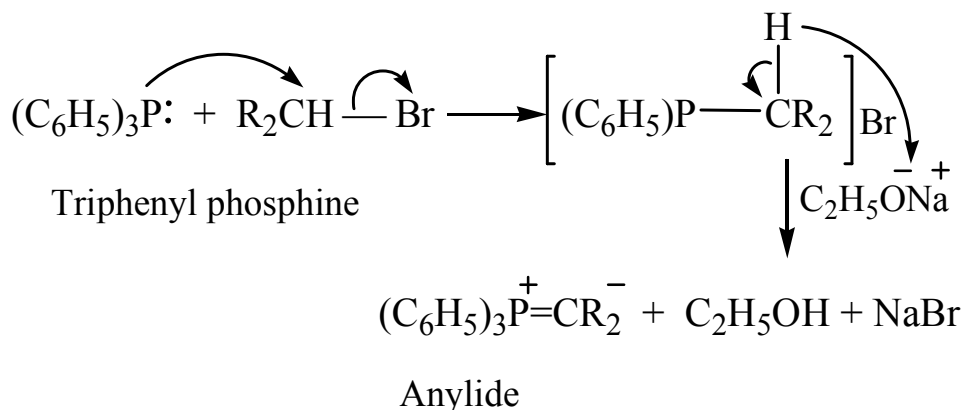

Mechanism: Two Steps are involved:

Step 1: the negative carbon of the ylide attacks the carbonyl carbon to form betaine. A betaine is a molecule having non adjacent opposite charges.

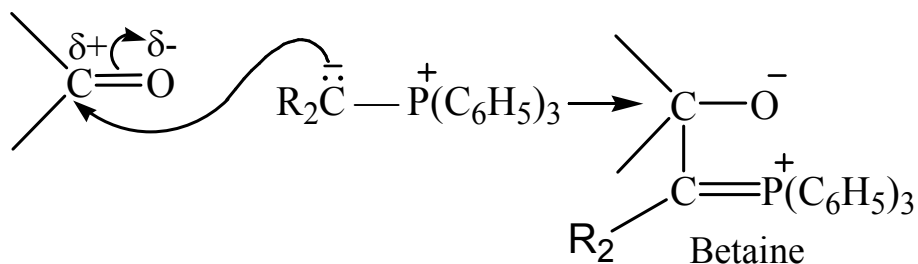

Step 2: The betaine undergoes elimination of triphenylphosphine oxide to give the alkene.

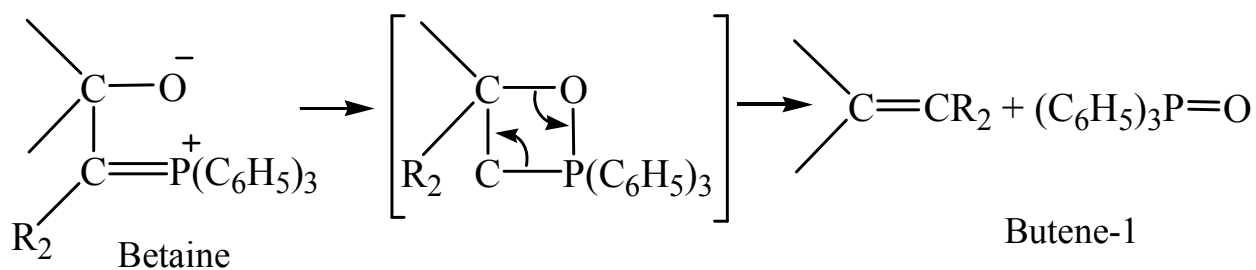

The Wittig's reaction is an excellent method of making alkenes from aldehydes and ketones. For example:

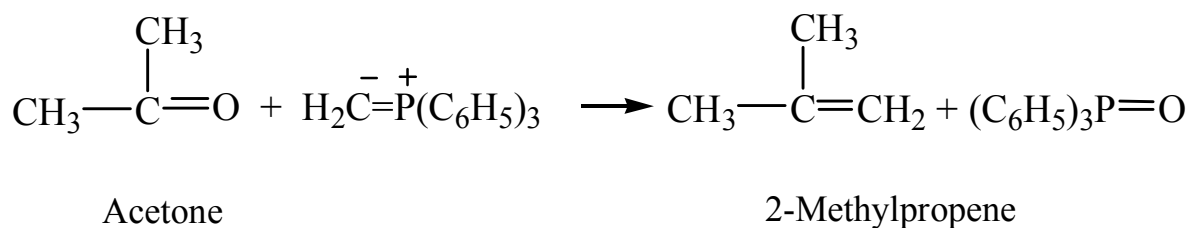

(17) Reaction with Phosphorus Pentachloride: Both aldehydes and ketones react with PCl_5 to form gem dihalide. For example acetaldehyde gives 1,1dichloroethane.

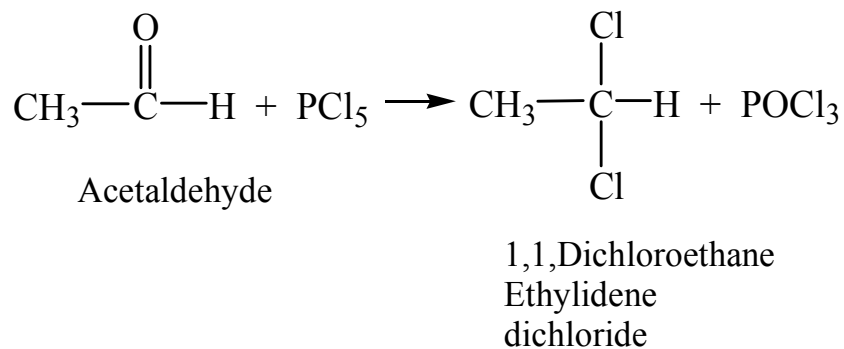

Acetone reacts with PCl_5 to form 2,2 dichloropropane.

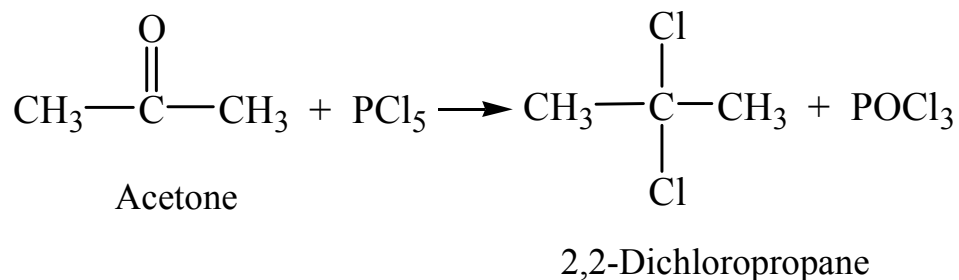

(18) **Schiff's Test:** Dilute solutions of aldehydes when added to Schiff's reagent (rosaniline hydrochloride dissolved in water and its red color decolorized by passing sulphur dioxide) restores its red color. This is known as Schiff's test for aldehydes. Ketones do not give this test.

(19) **Polymerization:** The first few members of the aldehydes series readily undergo polymerization to give a variety of products (for details see formaldehyde and acetaldehyde) ketones however are not much susceptible to polymerization.

(20) **Formaldehyde:** Method HCHO

Formaldehyde is the simplest member of the aldehyde family.

Preparation: It is manufactured

1. By the hydrogenation method methanol vapours are passed over heated silver catalyst at 300°C.

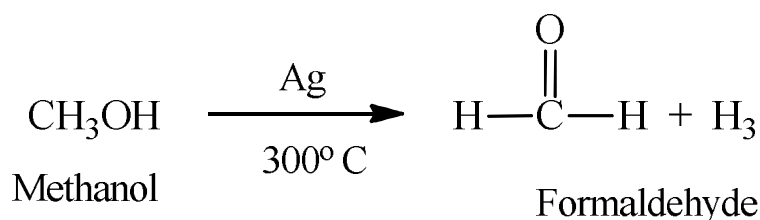

2. By air oxidation of methanol. Methanol vapours and limited amount of air are passed over heated silver catalyst at 450°C.

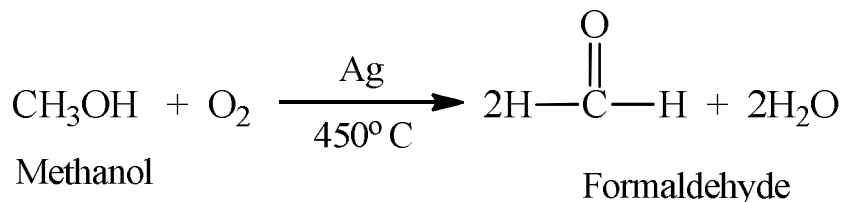

3. By air oxidation of Methane in presence of various metallic oxides.

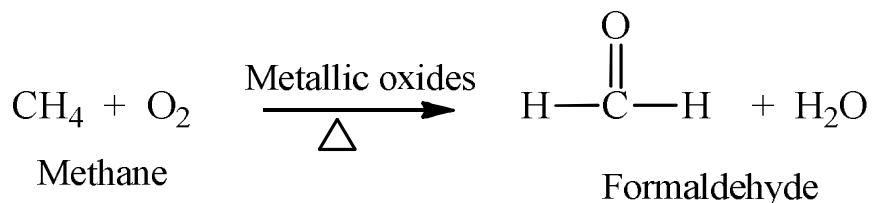

Since formaldehyde is a gas the products is marked as 40% aqueous solution under the name Formalin.

Properties: (Physical) Formaldehyde is a colorless gas by -20°C . It has an irritating odor. It is extremely soluble in water.

(Chemical) Formaldehyde is different from other aldehydes. It contains no alkyl group in its molecule. Both hydrogen atoms may be regarded as being part of an aldehyde group.

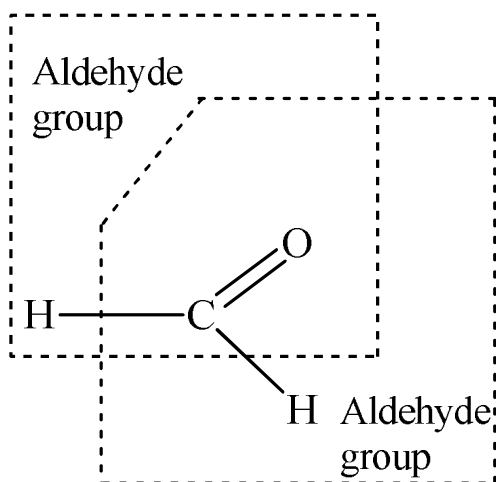

As a result several reactions of formaldehyde are different from those of other aldehydes.

(1) **Reaction with ammonia:** when treated with ammonia it does not give an aldehyde ammonia but forms hexamethylenetetramine.

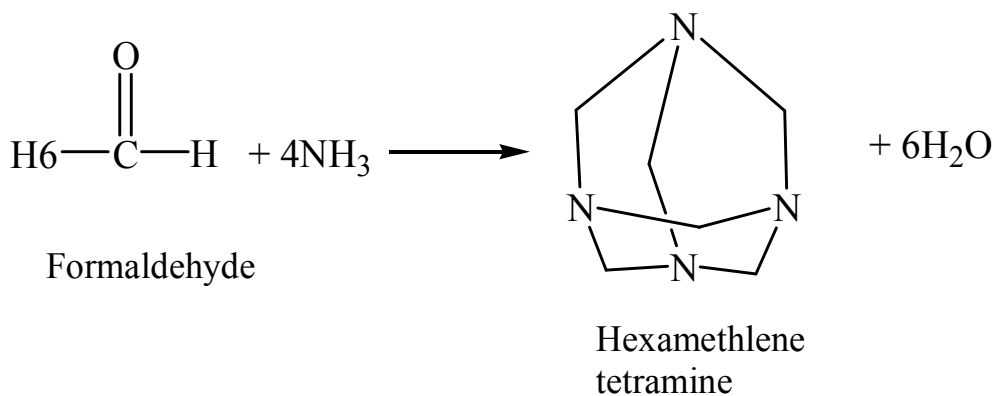

Hexamethylenetetramine is used as a urinary antiseptic and has been given the trade name of Urotropine.

(2) **Reaction with sodium hydroxide (Cannizzaro reaction):** Formaldehyde reacts with concentrated NaOH solution to form methanol and sodium formate.

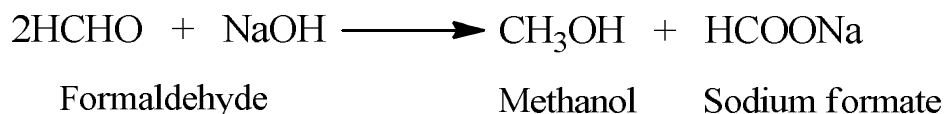

- (3) **Reaction with alcohols:** Like other aldehydes it reacts with alcohol to form acetals. for example formaldehyde reacts with methanol and in the presence of dry HCl to form Methylal.

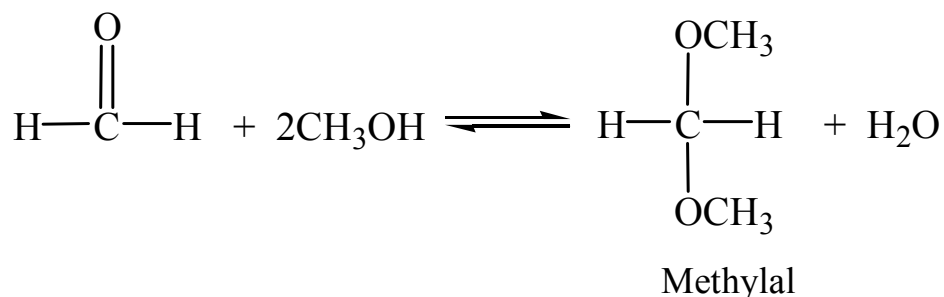

- (4) **Polymerization:** formaldehyde polymerises as follows:

- (a) When aqua solution of formaldehyde (Formalin) is evaporated to dryness Paraformaldehyde is formed.



Paraformaldehyde

(n=6-50)

Paraformaldehyde is a crystalline solid m.p 121.123°Celsius. It re-generates formaldehyde on heating because paraformaldehyde is readily re-converted into formaldehyde upon gentle heating it serves as a convenient storage form of formaldehyde

- (b) Formaldehyde on treatment with concentrated H_2SO_4 gives Polyoxymethyl-ene- $[\text{CH}_2\text{O}]_n$ - where $n > 100$. Polyoxymethylene are insoluble white solids which re-generate formaldehyde on heating.
- (c) When formaldehyde gas is allowed to stand at room temperature, it polymerizes and forms a white solid called metaformaldehyde or Trioxane.

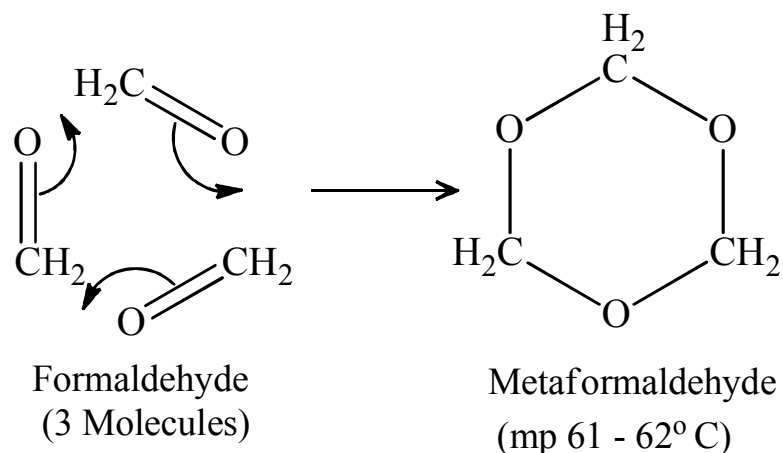

- (5) **Condensation with phenol:** Formaldehyde condenses with phenol to give a synthetic plastic bakelite. Phenol is refluxed with Formalin and 0.88 ammonia (catalyst) when an oil separates, the oily liquid is transferred to an open vessel and heated until a test sample on cooling in water is found to be hard and brittle. It is then left to cool to give bakelite.

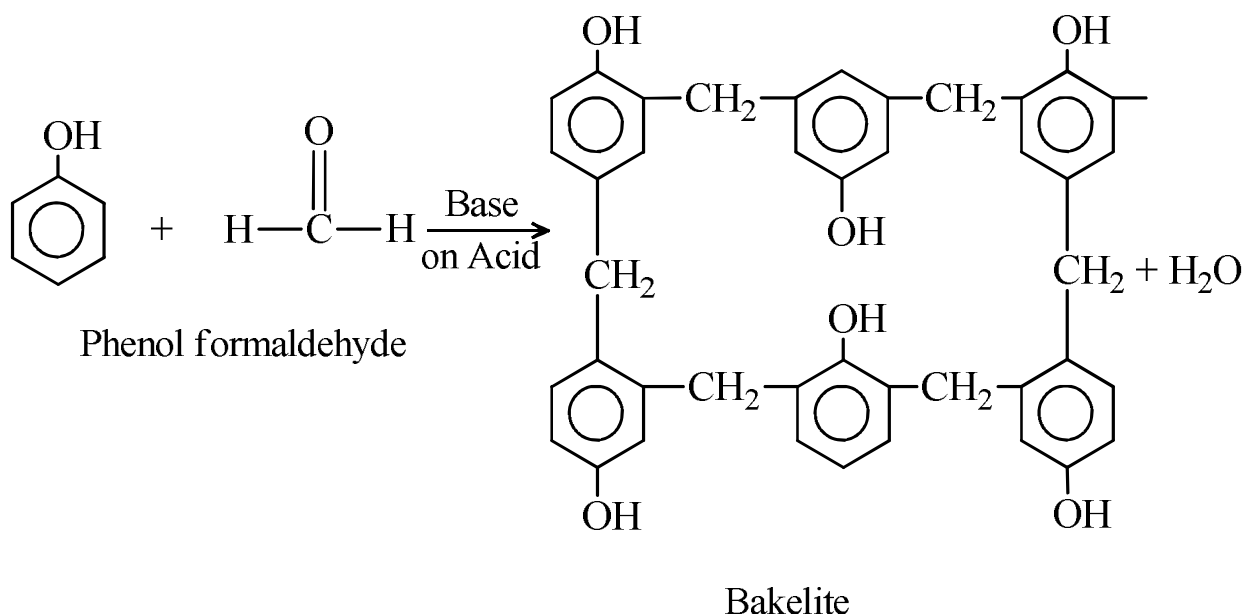

Uses: Formaldehyde is solid at 40 degree, its aqua solution is sold under the name Formalin and is used in this form for most purposes. Formalin is used: (1) As a General antiseptic; (2) In the manufacture of Urinary antiseptic (Urotropine); (3) In the preservation of biological specimens; (4) In the manufacture of synthetic dyes like pararosaniline and Indigo; (5) In the manufacture of synthetic plastics such as Bakelite and Melmac.

Acetaldehyde (CH₃CHO):

Acetaldehyde is the most important member of the aldehyde family.

Laboratory Preparation: Acetaldehyde is prepared in the laboratory by oxidation of ethanol with acidified sodium dichromate solution.

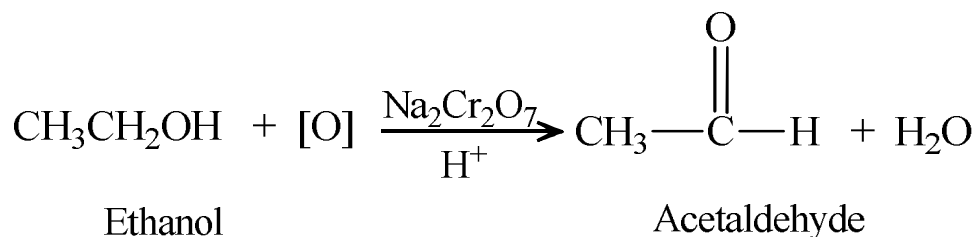

The Apparatus used is shown in Fig. 19.2. A mixture of ethanol and sodium dichromate solution is run into boiling dilute H_2SO_4 as the liquid comes in contact with the acid of vigorous reaction takes place and orange dichromate is reduced. The green chromic sulphate acetaldehyde containing impurities such as ethanol acetic acid and water distills over.

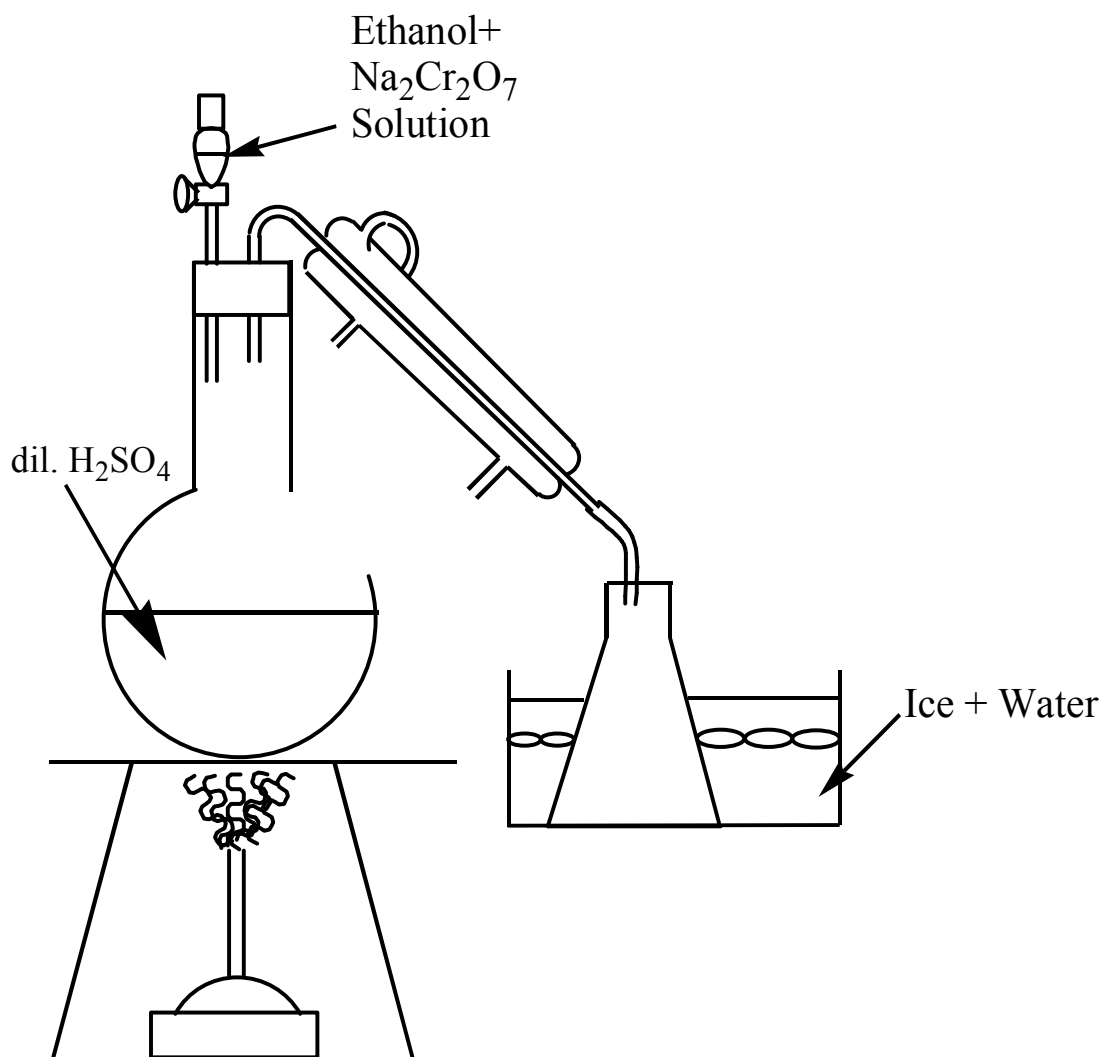

The impure acetaldehyde is purified by converting it into acetaldehyde-ammonia by treatment with ammonia. The crystals of acetaldehyde ammonia are dried and distilled with dilute sulphuric acid and the re-generated acetaldehyde is collected in an ice cold receiver.

Manufacture: Acetaldehyde is manufactured:

- (1) **By air oxidation of ethanol:** Ethanol vapours and Limited amount of air are passed over heated silver catalyst of 500° C.

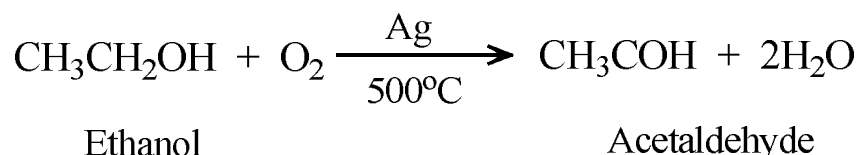

- (2) **By dehydrogenation of ethanol:** Ethanol vapours are passed over heated copper catalyst at 500° C.

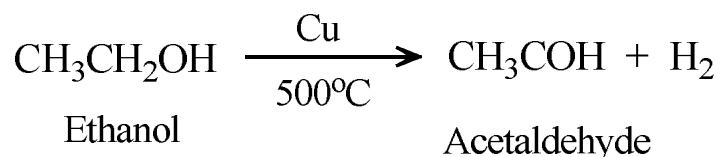

- (3) **By hydration of acetylene:**

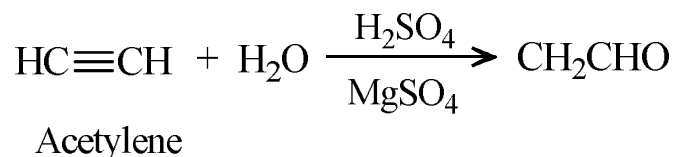

- (4) **By Wacker process:** This involves the treatment of Ethylene with and acidified aqueous solution of palladium chloride and cupric chloride.

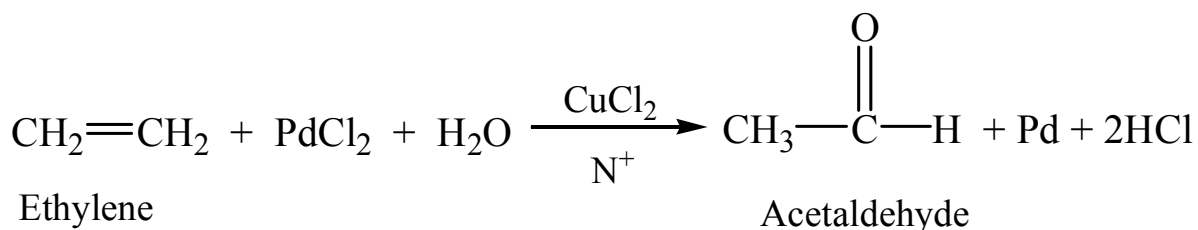

Properties (Physical): Acetaldehyde is a colorless volatile liquid at 21° C. It has a characteristic pungent smell acetaldehyde is soluble in water chloroform ethanol and diethyl Ether.

(Chemical) The chemical properties of acetaldehyde have already been discussed under the ‘General Reactions’ of aldehydes and ketones. Only a few polymerization reactions will be described here.

- (1) When acetaldehyde is treated with a small amount of concentrated H_2SO_4 at room temperature, a cyclic trimer Paraldehyde is formed.

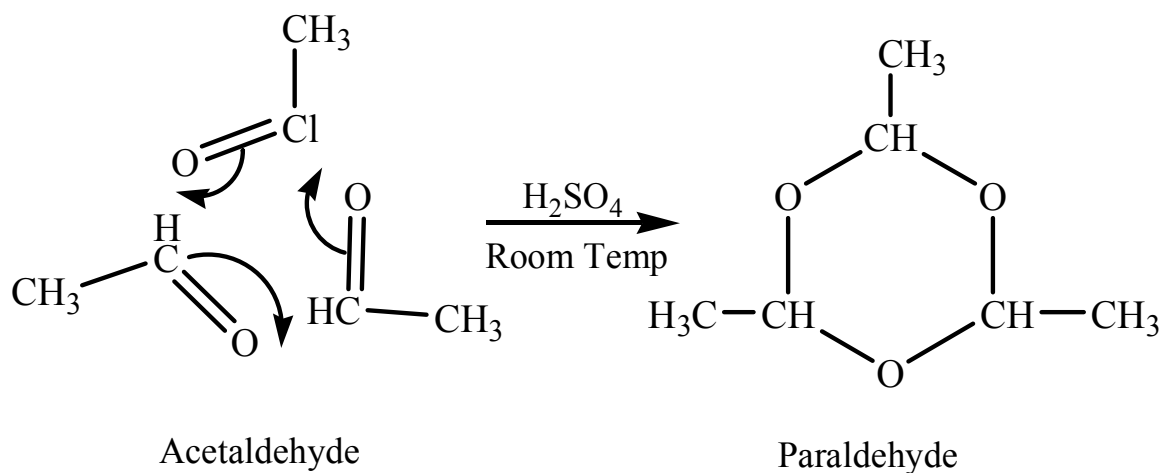

Paraldehyde is a liquid b.p. $128^\circ C$. It re-generates acetaldehyde on distilling with concentrated H_2SO_4

- (2) When acetaldehyde is treated with small concentrated H_2SO_4 at $0^\circ C$ a cyclic tetramer metaldehyde is formed.

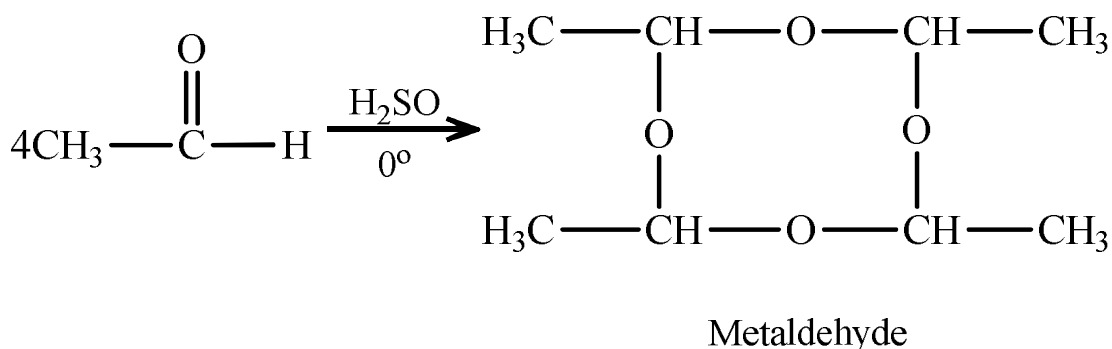

Metaldehyde is a solid MP $246^\circ C$. This tetramer is used for killing slugs and snails.

Uses: Acetaldehyde: It is used in the manufacture of (1) Acetic Acid ; (2) Chloral, chlorine is first passed into cold ethanol and then at $60^\circ C$ till no further absorption of chlorine takes place. The final product is chloral alcoholate which separates as a crystalline solid this on distillation with H_2SO_4 gives chloral. The reactions involved can be shown.

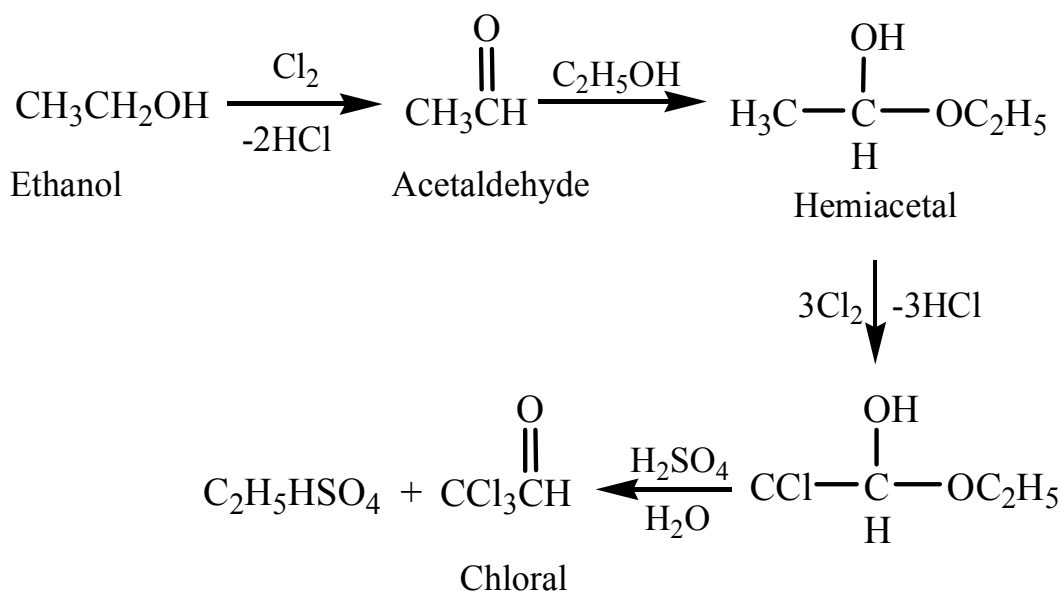

Properties: Chloral is a colourless oily liquid BP 98 °C. It has a pungent odour chloral shows most of the usual reactions of aldehydes. It gives addition reaction with Ammonia hydrogen cyanide and sodium bisulphite. It undergoes condensation reactions with hydroxylamine hydrazine and phenylhydrazine. Some other reactions of chloral are:

- Oxidation:** Chloral is oxidized by concentrated nitric acid to give trichloroacetic acid.

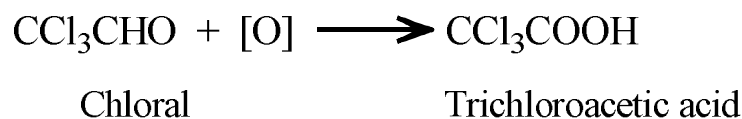

- Reduction:** Chloral is reduced by aluminium ethoxide to give trichloroethanol

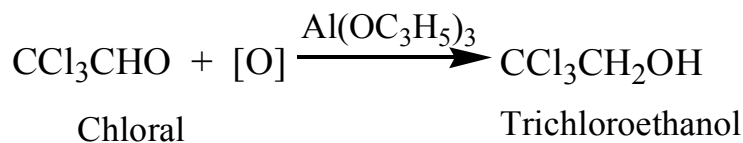

- Reactions with NaOH:** When heated with concentrated sodium hydroxide solution it yields pure chloroform

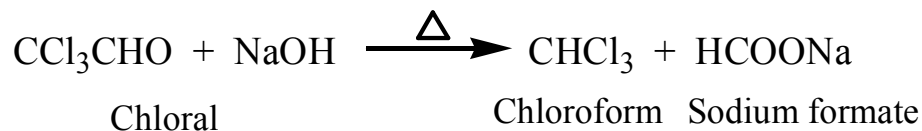

- Reaction with Water and Ethanol:** When chloral is treated with water or ethanol it forms chloral hydrate (M.P 57° C) and chloral alcoholate (M.P 46° C), respectively. These

compounds are stable and the water or ethanol can only be removed by treatment with concentrated sulphuric acid.

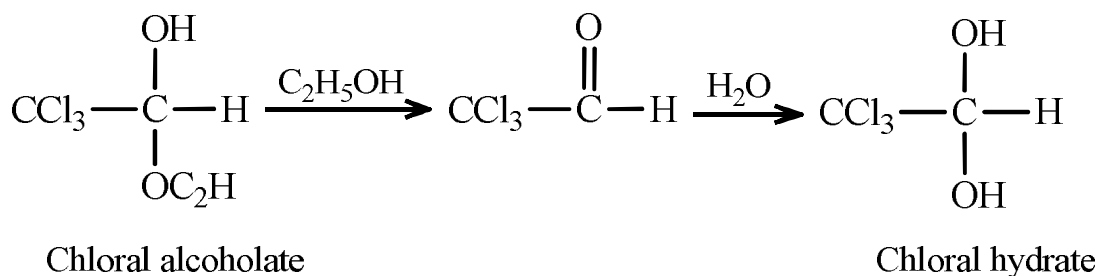

The stability of chloral hydrate is unexpected because the presence of two -OH groups on the same carbon atom should make the molecule unstable. The usual stability of chloral hydrate can be explained as follows: the strong effects of the three chlorine atoms gives the carbon atom of the carbonyl group a small positive charge which prevents the release of a hydroxyl ion. Thus the elimination of water molecule becomes difficult. Also, the **IR Spectrum** of chloral hydrate shows intramolecular hydrogen bonding between the chlorine and hydrogen atoms.

Uses: Chloral is used in the manufacture of DDT an important insecticide. It has been used in medicine as hypnotic. Acrolein is the simplest unsaturated aldehyde.

Preparation: Acrolein is prepared by the dehydration of glycerol with potassium hydrogen sulphate.

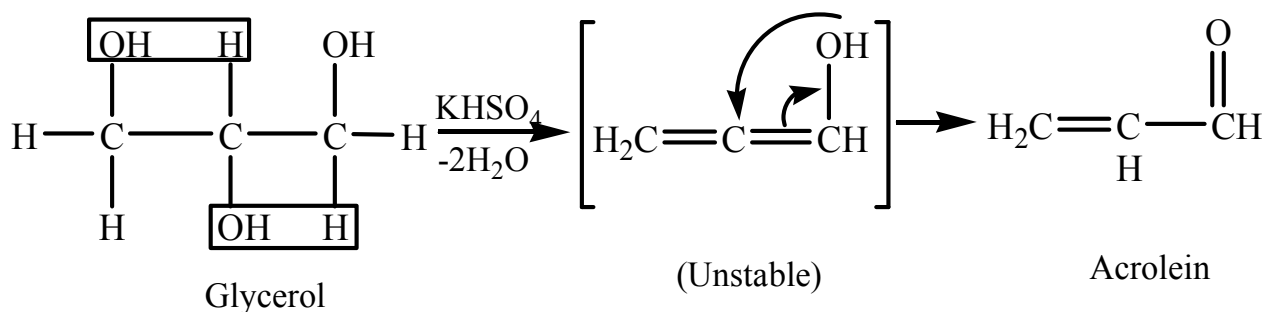

Properties: Acrolein is a colourless pungent smelling liquid with b.p. of 52° C. Acrolein molecule contains both carbon carbon double bond and an aldehyde group. Thus it behaves both like alkene and an aldehyde. However acrolein shows modified behaviour because it occurs as a resonance hybrid.

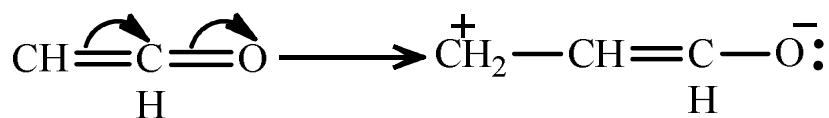

Some of the important reactions of acrolein are described below:

- (1) **Addition of Br₂:** Bromine adds to acrolein to form 2,3 dibromopropanal.

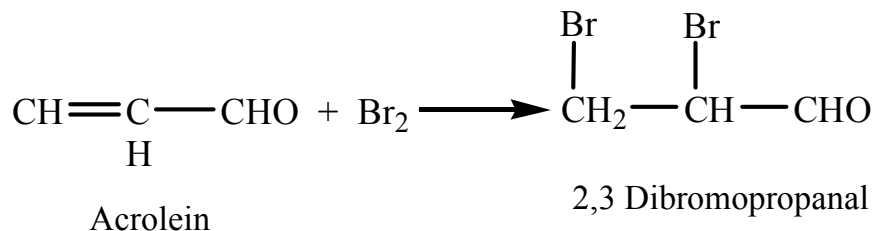

- (2) **Addition of HCl:** Hydrogen chloride adds to acrolein to form 3 chloropropanal

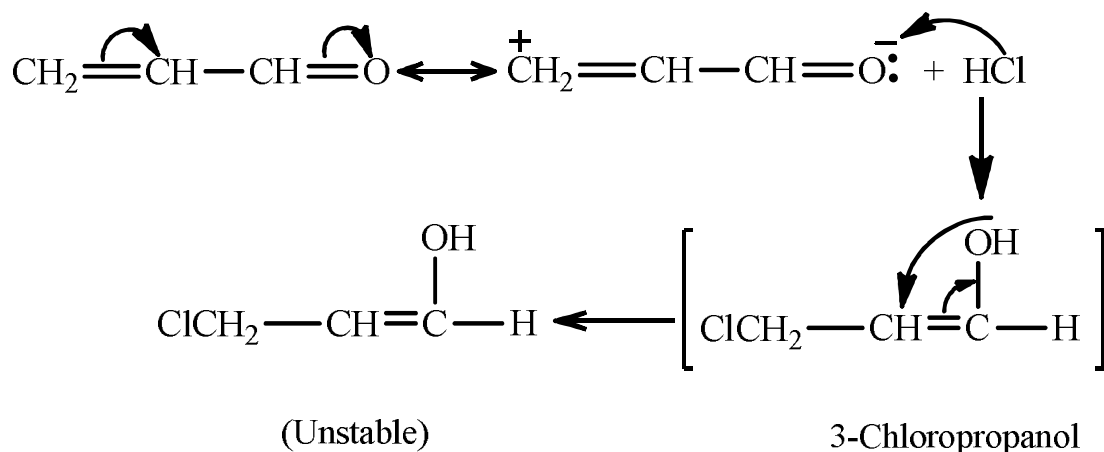

- (3) **Oxidation:** Acrolein undergoes oxidation with ammoniacal silver nitrate to give acrylic acid

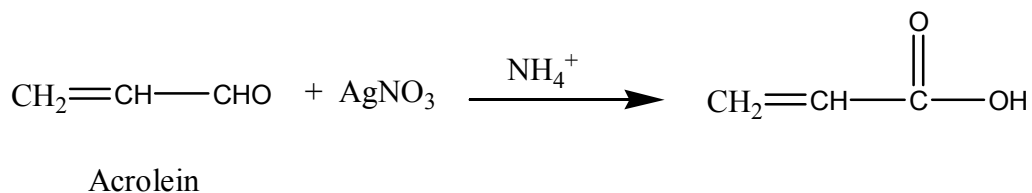

- (4) **Reduction:** acrolein undergoes reduction with LiAlH₄ to give allyl alcohol.

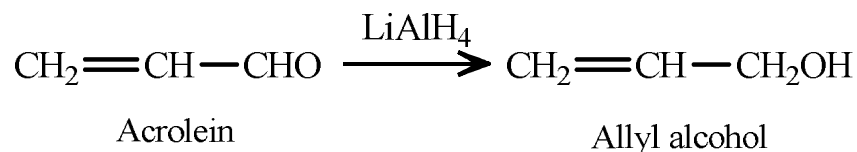

Uses: Acrolein is used: (1) as a tear gas; (2) in the manufacture of insecticides; (3) in the preparation of acrolein Urea formaldehyde resins

Acetone (CH₃-CO-CH₃):

Acetone is the most important member of the ketones family.

Laboratory Preparations: Acetone is prepared in the laboratory by oxidation of isopropyl alcohol (2- Propanol) with acidified sodium dichromate solution.

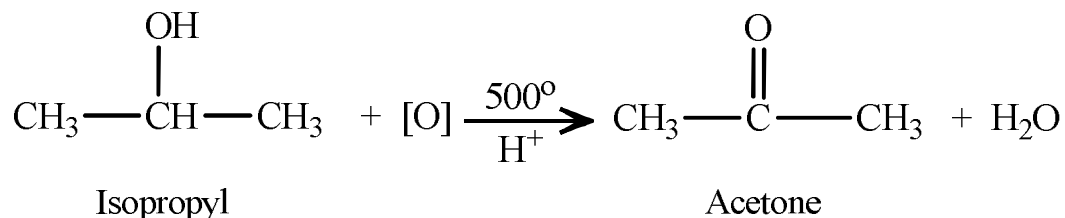

The Apparatus used is the same as for acetaldehyde (Fig 19.2). To a mixture of isopropyl alcohol and sodium dichromate solution is run into boiling dilute H₂SO₄. As the liquid comes in contact with the acid a vigorous reaction takes place and the orange dichromate is reduced to Green chromic sulphate. Impure acetone distills over. The impure acetone is purified by adding sodium bisulfite solution filtering of the crystals of the bisulfite compound obtained and regenerating Acetone by decomposing the crystals with dilute alkali. The acetone is then distilled (BP 58° C)

Manufacture: Acetone is manufactured.

- (1) By air oxidation of isopropyl alcohol at 500° C. No catalyst is required

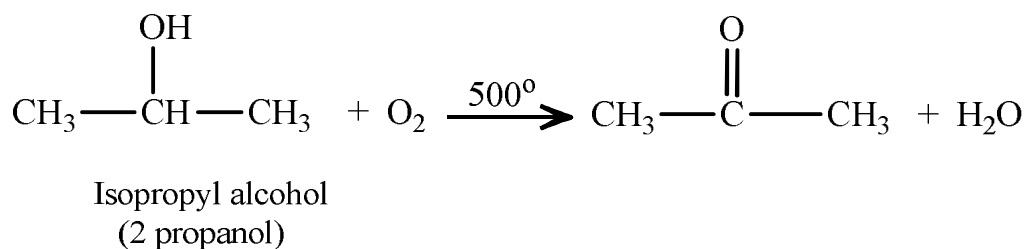

- (2) By dehydrogenation of isopropyl alcohol: Isopropyl alcohol vapours are passed over heated copper catalyst at 300° C.

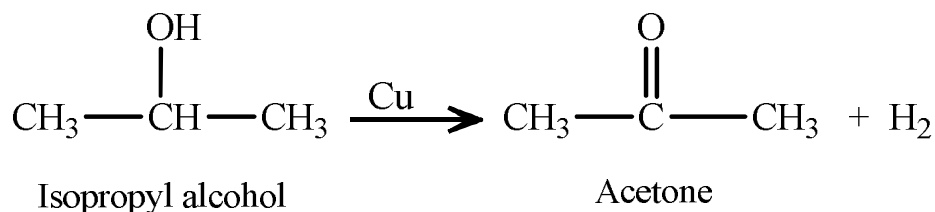

- (3) By Wacker process. This involves the treatment of propene with an acidified aqua solution of palladium chloride and cupric chloride.

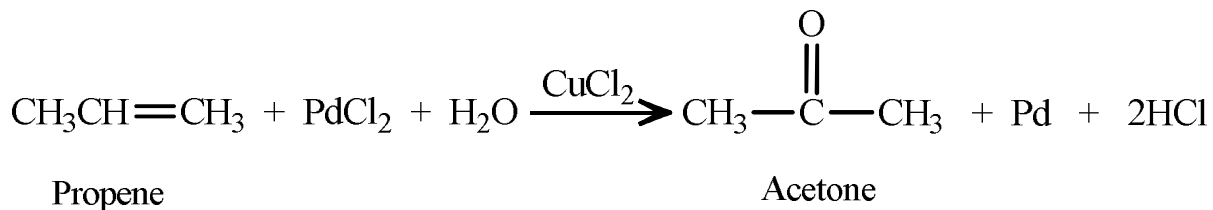

Acetones are also obtained by products of Cumene Process for the manufacture of phenol. This process for the preparation of acetone by fermentation of carbohydrates and also from calcium acetate are obsolete.

Note: Acetone is highly volatile and flammable.

Properties: (Physical) Acetone is a colorless volatile highly flammable liquid BP of 56° C, it has an ethereal odour. It is miscible with ethanol and methanol. The chemical properties of acetone have already been discussed under 'General Reactions' of aldehyde and ketones.

- (1) **Haloform reaction:** when acetone is treated with bleaching powder ($\text{CaOCl}_2 = \text{CaO} + \text{Cl}_2$) which supplies both chlorine and alkali, it first forms trichloro acetone which on hydrolysis gives chloroform.

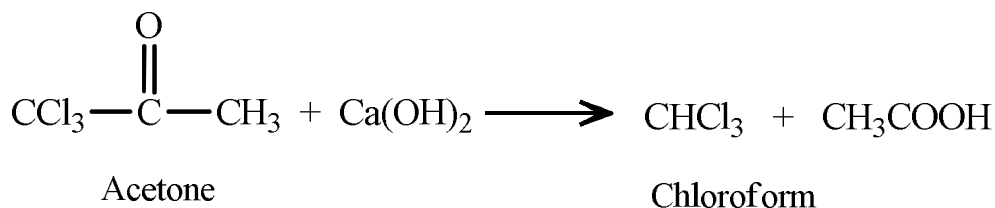
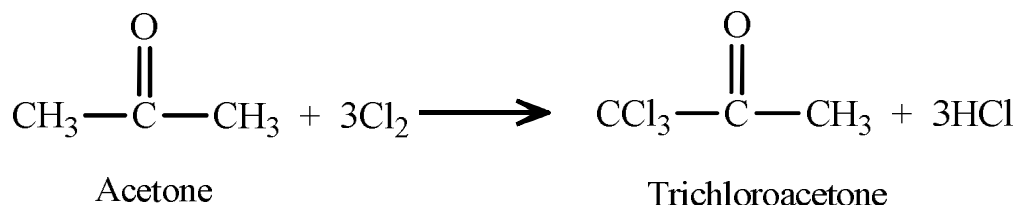

A similar reaction with iodine and alkali gives iodoform

- (2) **Condensation Reactions:** Acetone undergoes the following condensation reactions.
- (a) When treated with dry NCl Acetone first gives mesityl oxide then phorone.

Formation of Mesityl oxide:

1.

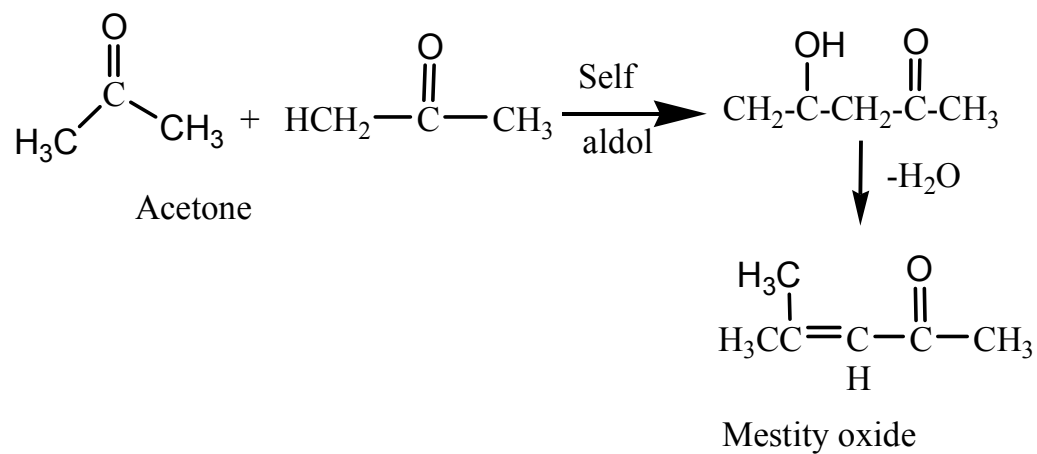

Formation of Phorone:

2.

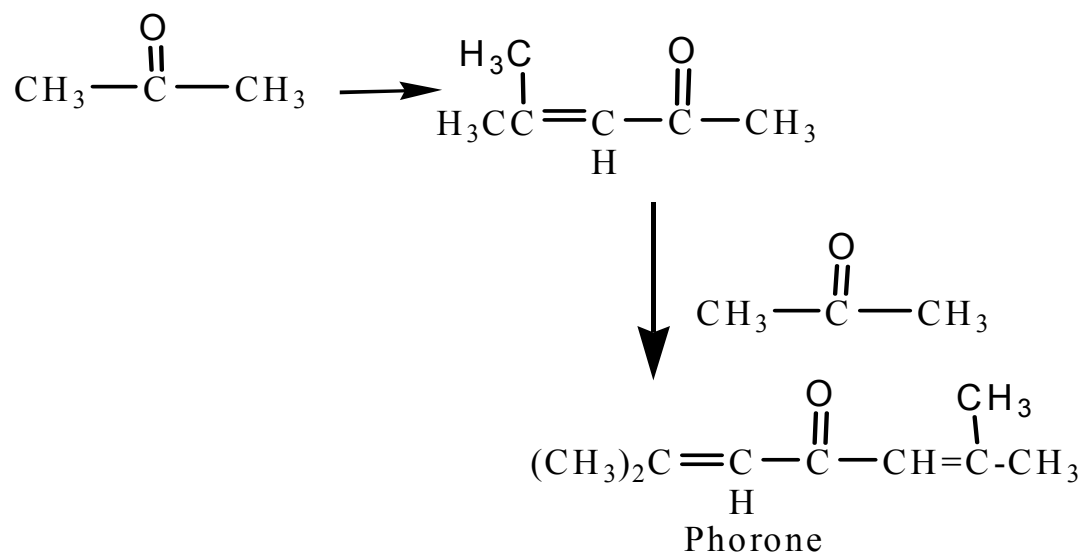

(b) When treated with H_2SO_4 acetone gives mesitylene.

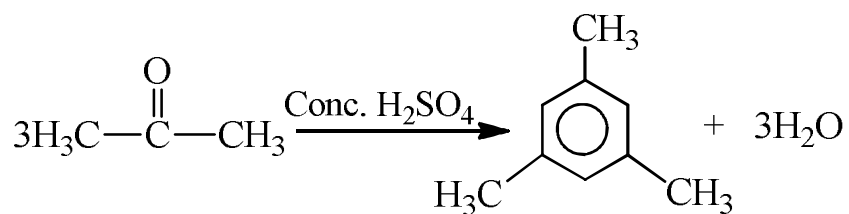

- (c) When treated with $\text{Ba}(\text{OH})_2$ Acetone undergoes aldol condensation to form diacetone alcohol.

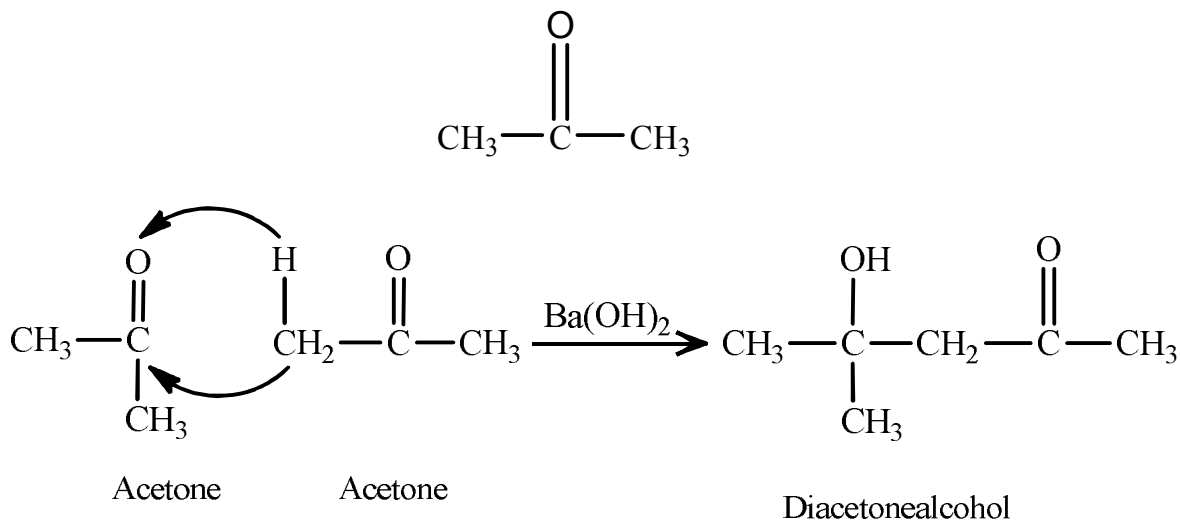

Uses: Acetone is used: (1) as a solvent for acetylene cellulose derivatives, varnishes, lacquer resins and plastics; (2) in the production of chloroform and diacetone alcohol; (3) in the manufacture of thermo softening plastic Perpex.

Methyl ethyl Ketone: 2-Butanone $\text{CH}_3\text{COCH}_2\text{CH}_3$

4.7 Terminal Questions

- Q.1 Write the structural formulas and give IUPAC names for all aldehydes and ketones of the molecular formula $\text{C}_5\text{H}_{10}\text{O}$?
- Q.2 How are aldehydes prepared? Describe their important reactions.
- Q.3 How are ketones prepared? Describe the important reactions.
- Q.4 How is acetaldehyde prepared in the laboratory? How does it react with reagents?
- Q.5 How is formaldehyde prepared in the laboratory? How does it react with reagents?
- Q.6 How is Acetone prepared in the laboratory? How does it react with reagents?
- Q.7 Describe the preparations and properties of acrolein?
- Q.8 What is the structure of the carbonyl group? How does it react ?
- Q.9 What happens when acetaldehyde is treated with dilute NaOH ?

- Q.10 What happens when formaldehyde is treated with concentrated NaOH solution?
- Q.11 What happens when Acetone is heated with solid barium hydroxide?
- Q.12 What happens when calcium acetate is heated?
- Q.13 Aldehydes and ketones forms hydrocarbons by which reactions?
- Q.14 How will you distinguish between acetaldehyde and acetone?
- Q.15 How will you distinguish between formaldehyde and acetaldehyde?
- Q.16 How will you distinguish between 2-pentanone and 3-pentanone?
- Q.17 Give the general mechanism of nucleophilic addition reactions of carbonyl compounds.
- Q.18 Give the mechanism of addition of HCN to acetaldehyde.
- Q.19 Give the mechanism of addition of HCN to acetone.
- Q.20 Discuss the mechanism of aldol condensation?
- Q.21 Discuss the mechanism of Cannizzaro Reaction?
- Q.22 Write a note on: Aldol condensation?
- Q.23 Write a note on: Cannizzaro Reaction?
- Q.24 Write a note on: Wittig reaction?
- Q.25 Write a note on: Reformatsky reaction?
- Q.26 How will you synthesise acetaldehyde from formaldehyde?
- Q.27 How will you synthesise acetone from acetaldehyde?
- Q.28 How will you synthesise lactic acid from acetylene?
- Q.29 How will you synthesise 2 butanone from ethyl alcohol?
- Q.30 An alkene C_6H_{12} after ozonolysis yielded two products one of these gives a positive iodoform reaction but a negative Tollens test the other product gives a positive Tollens test but negative iodoform reaction? What is the structure and IUPAC name of the alkene?

Unit 5: Carboxylic Acids and Derivatives

5.1 Introduction

Objective

5.2 Nomenclature of Aliphatic and Aromatic Carboxylic Compounds

5.3 Methods of Preparation of Carboxylic Acid

5.4 Structure of Carboxylic Acid

5.5 Physical Properties of Carboxylic Acids

5.6 Chemical Properties of Carboxylic Acids

5.7 Acid Strength of Carboxylic Acids (Effect of substituents)

5.8 Nomenclature of Halo Acids

5.9 Methods of preparation of Halo acids

5.10 Properties of Halo acids

5.11 Hydroxy Acids

5.12 Methods of preparation of hydroxy acids:

5.13 Properties of hydroxy acid

5.14 Salicylic Acid: Methods of preparation

5.15 Properties of salicylic acid

5.16 Unsaturated Monocarboxylic Acids

5.17 Methods of preparation of α,β -unsaturated acids

5.18 Properties of α,β -unsaturated acids

5.19 Dicarboxylic acids

5.20 Preparation of oxalic acid

5.21 Properties of oxalic acid

5.22 Uses of oxalic acid

5.23 Malonic acid: Methods of preparation of malonic acid

- 5.24 Properties of malonic acid
- 5.25 Maleic acid: Methods of preparation of maleic acid
- 5.26 Properties of Maleic acid
- 5.27. Fumaric acid: Methods of preparation of fumaric acid
- 5.28 Properties of Fumaric acid
- 5.29 Malic acid: Methods of Preparation of Malic Acid
- 5.30 Properties of Malic Acid
- 5.31 Tartaric acid: Methods of preparation of tartaric acid
- 5.32 Properties of Tartaric acid
- 5.33 Citric acid: Methods of preparation of citric acid
- 5.34 Properties of citric acid
- 5.4 Carboxylic acid Derivatives
 - 5.41 Nomenclature of Esters
 - 5.42 Methods of preparation of Ester
 - 5.43 Physical properties of esters
 - 5.44 Chemical properties of esters
 - 5.45 Mechanism of acid catalyzed and base catalysed hydrolysis of an ester
- 5.5 Acid anhydrides
 - 5.51 Nomenclature of acid anhydrides
 - 5.52 Methods of preparation of acid anhydride
 - 5.53 Properties of acid anhydrides
- 5.6 Acid amides: Nomenclature of acid amides
 - 5.61 Method of preparation of amides
 - 5.62 Properties of amides

5.7 Acid chloride : Nomenclature of acid chloride

5.71 Method of preparation of acid chloride

5.72 Properties of acid chloride

5.8 Urea: Methods of preparation of urea

5.81 Properties of urea

5.82 Estimation of urea

5.9 Terminal Questions

5.1 Introduction

Carboxylic acids are organic compounds containing $-\text{COOH}$ or carboxy group. Such compounds can be represented by the general formula $\text{R}-\text{COOH}$, where R stands for some aliphatic or aromatic group.

Carboxylic compounds can be classified as follows:

Monocarboxylic compounds: Those containing one carboxy group in the molecules such as acetic acid, butyric acid.

Dicarboxylic compounds: Those containing 2 carboxy groups in the molecule such as oxalic acid, malonic acid.

Tricarboxylic compounds: Those containing three carboxy groups in the molecule such as citric acid.

The carboxyl group $\begin{array}{c} \text{O} \\ \parallel \\ -\text{C}-\text{OH} \end{array}$ consists of two groups viz $\begin{array}{c} \text{O} \\ \parallel \\ -\text{C}- \end{array}$ (carbonyl group) and $-\text{OH}$ (hydroxyl group).

The word carboxy is derived from the two groups-carbonyl and hydroxy.

Objectives

Learner is able to define the following:

- Nomenclature of aliphatic and aromatic carboxylic compounds
- Methods of Preparation of some Carboxylic Acid
- Structure of Carboxylic Acid
- Physical Properties of some Carboxylic Acids
- Chemical Properties of some Carboxylic Acids

2. **IUPAC System:** In this system, carboxylic acid is known as alkanolic acids. Total carbon atoms in the longest chain containing the carboxylic group and including the carboxylic carbon atom are counted. The carboxylic compounds are the derivative of the alkane with as many carbons as the acid. Thus if there are 4 carbons in the acid, it is a derivative of butane; if there are 5 carbons, it is a derivative of pentane; and so on.

The -e of the alkane is changed into -oic acid.

Some examples are given below:

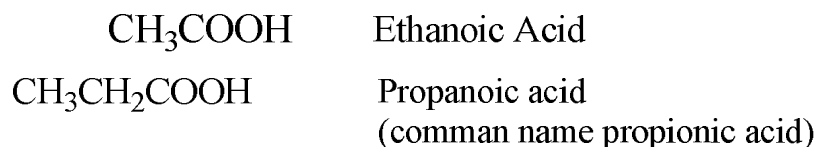

For naming substituted acids, according to IUPAC system again we identify groups which are attached and positions where these are attached.

But the numbering of positions is done in different manner.

The carboxyl group carbon is given no.1 position, next one no.2 position and so on.

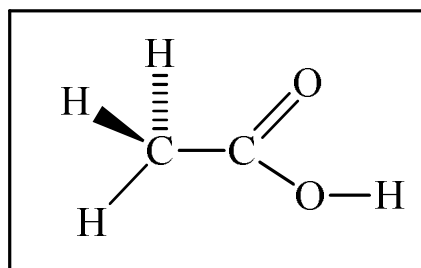
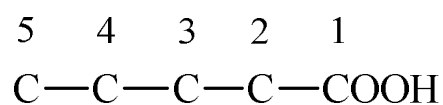

Thus the following compounds will be named, according to IUPAC system, as shown below against the compounds.

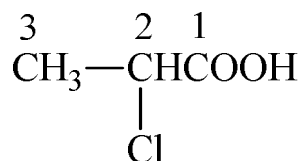

2-chloropropanoic acid

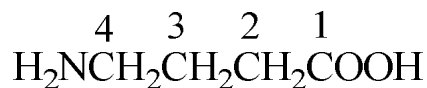

4-aminobutanoic acid

Table 5.1 gives the common and IUPAC names of some common Carboxylic compounds.

Table 5.1: Common and IUPAC names of some monocarboxylic acids

Monocarboxylic	Common name	IUPAC name
HCOOH	Formic acid	Methanoic acid
CH ₃ COOH	Acetic acid	Ethanoic acid
CH ₃ CH ₂ COOH	Propionic acid	Propanoic acid
CH ₃ CH ₂ CH ₂ COOH	n-Butyric acid	Butanoic acid
$\begin{array}{c} \text{CH}_3 - \text{CHCOOH} \\ \\ \text{CH}_3 \end{array}$	Isobutyric acid (α -Methylpropionic acid)	2-Methylpropanoic acid
CH ₃ (CH ₂) ₃ COOH	Valeric acid	Pentanoic acid
CH ₃ (CH ₂) ₄ COOH	Caproic acid	Hexanoic acid
CH ₃ (CH ₂) ₆ COOH	Caprylic acid	Octanoic acid
CH ₃ (CH ₂) ₈ COOH	Capric acid	Decanoic acid

CH ₃ (CH ₂) ₁₀ COOH	Lauric acid	Dodecanoic acid
CH ₃ (CH ₂) ₁₂ COOH	Myristic acid	Tetradecanoic acid
CH ₃ (CH ₂) ₁₄ COOH	Palmitic acid	Hexadecanoic acid
CH ₃ (CH ₂) ₁₆ COOH	Stearic acid	Octadecanoic acid

Nomenclature of Aromatic carboxylic acid:

The simplest aromatic carboxylic acid is benzoic acid.

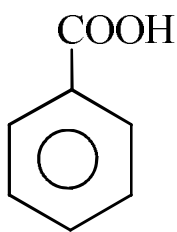

There may be other groups attached to the ring. These are indicated by mentioning the positions where these are attached.

The positions on the ring next to the position carrying $-\text{COOH}$ group is ortho (o), next that is meta (m) and still next is para (p) thus,

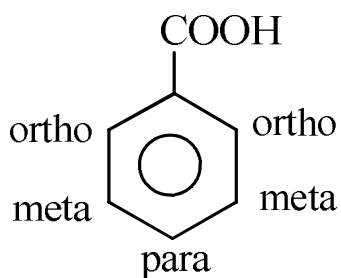

In IUPAC system, carboxy groups position is taken as no. 1 and then position are counted clockwise.

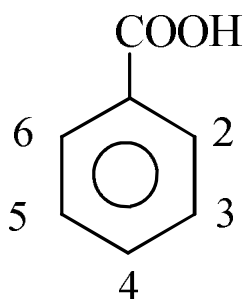

The name benzoic acid is accepted in IUPAC nomenclature. It is also named as benzene carboxylic acid in IUPAC nomenclature. Names of carboxylic compounds are given below.

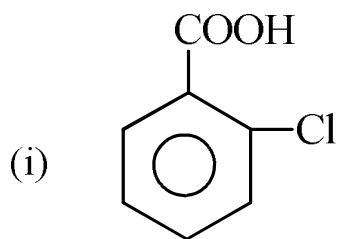

Ortho chlorobenzoic acid

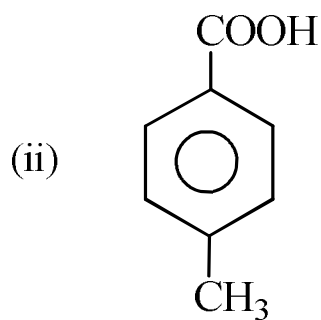

Para methylbenzoic acid

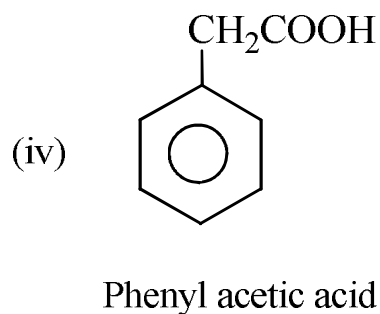
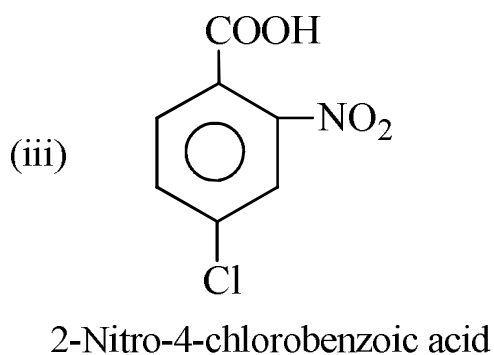

5.3 Methods of Preparation of Carboxylic Acid

Carboxylic acids (aliphatic and aromatic) can be prepared by the following methods:

- 1. Oxidation of alcohols and aldehydes:** Oxidation can be carried out in the presence of acidified KMnO_4 or $\text{K}_2\text{Cr}_2\text{O}_7$ or dilute nitric acid.

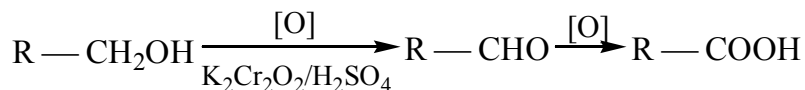

- 2. By oxidation of alkyl benzenes:** Alkyl benzene on oxidation with potassium permanganate yield carboxylic acid.

Whatever the length of the attached alkyl group, it is converted simply into $-\text{COOH}$.

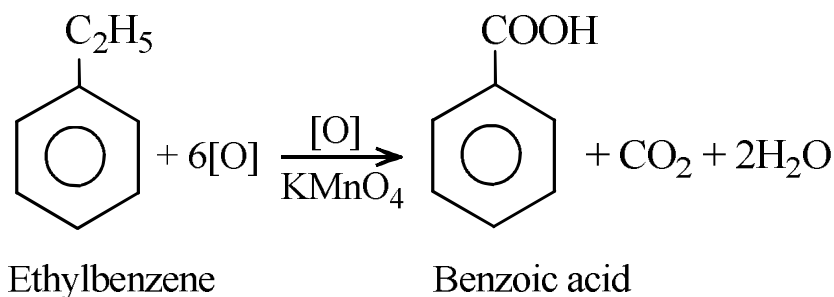
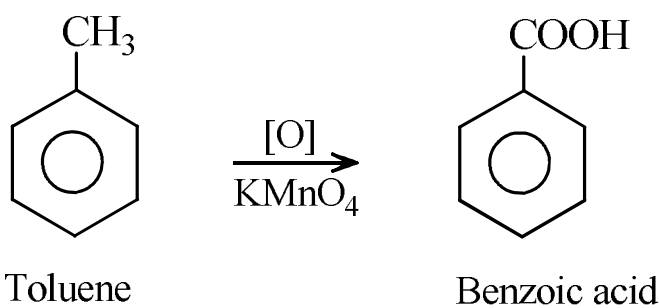

- 3. By hydrolysis of nitriles or cyanides:**

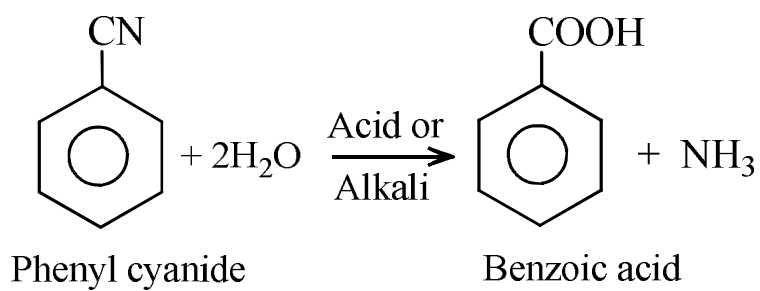
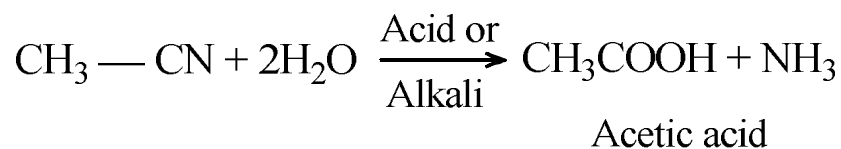
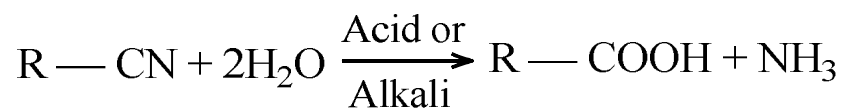

Mechanism:

Acidic hydrolysis

- 1) Hydrogen ion attaches itself to the cyano nitrogen atom with the shifting of charge to nitrogen and creation of positive charge on carbon.
- 2) Water molecule is attached to the carbonium ion.

The sequence of changes that takes place subsequently is shown here under.

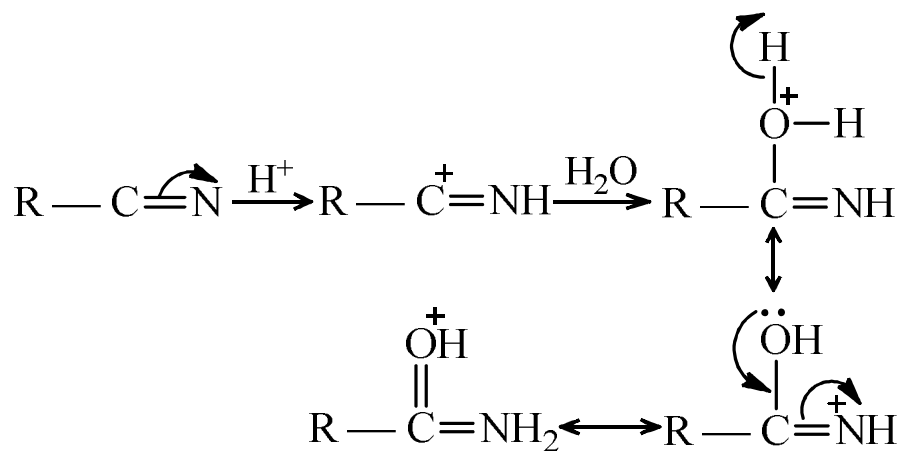

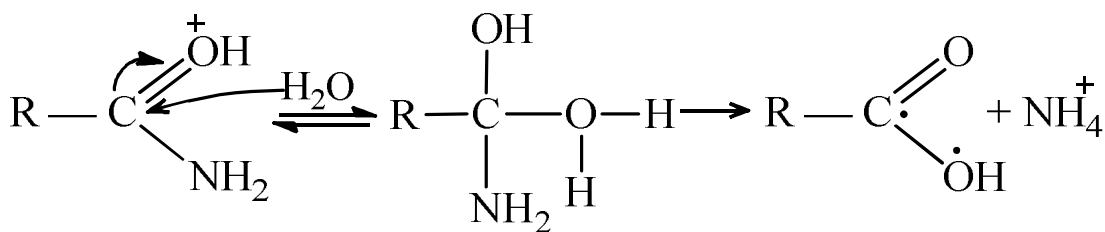

Alkaline hydrolysis

- 1) Here the electromeric charge takes place in the presence of hydroxyl group. Hydroxyl group is attached to the cyano carbon atom with a consequent negative charge on nitrogen.
- 2) H^+ is attached to negative nitrogen to produce the imine group $\text{C}=\text{NH}$.

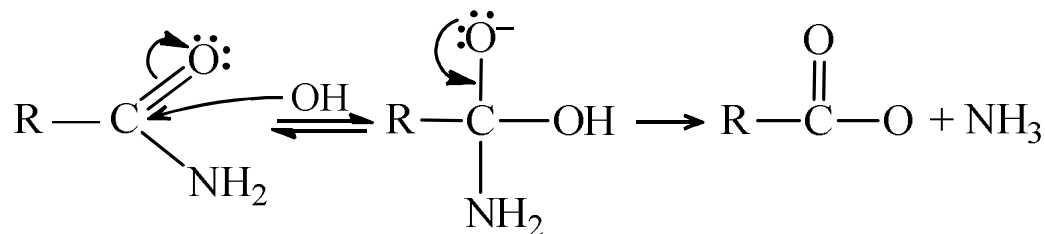
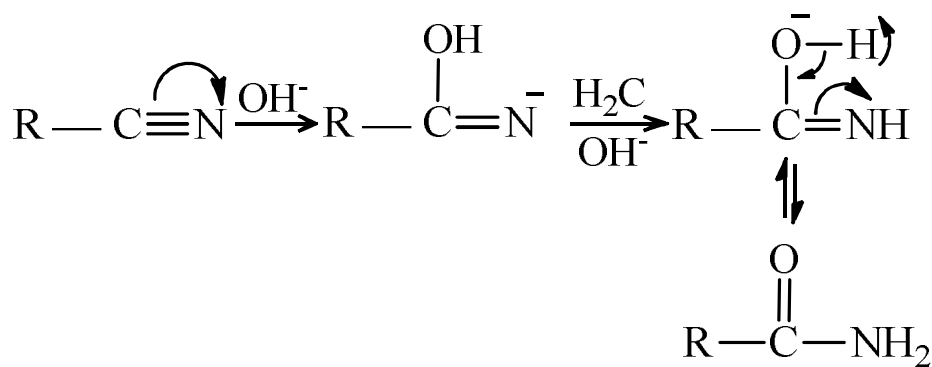

4. By hydrolysis of acid derivatives vis. acid chlorides, esters amides and anhydrides. The above acid derivatives on hydrolysis in the presence of an acid or alkali produce carboxylic acid.

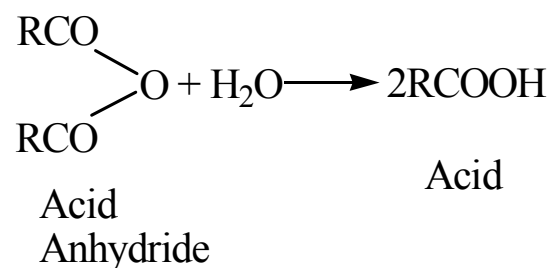
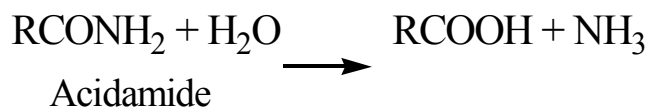
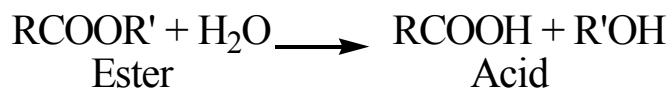
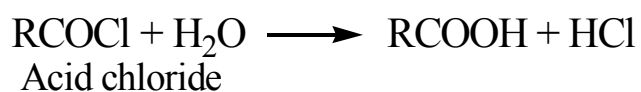

Mechanism:

An acid derivative could be represented as $\text{R}-\overset{\text{O}}{\parallel}{\text{C}}-\text{Y}$ where Y stands for Cl^- , $-\text{OR}$, $-\text{NH}_2$ or $-\text{OOCR}$ in case of acid chloride, ester, amide or anhydride respectively.

Acidic hydrolysis:

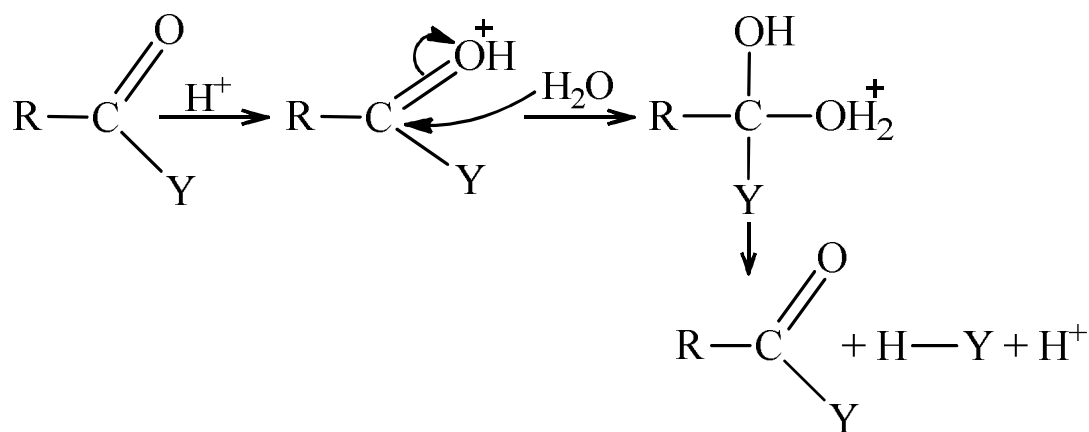

Alkaline hydrolysis:

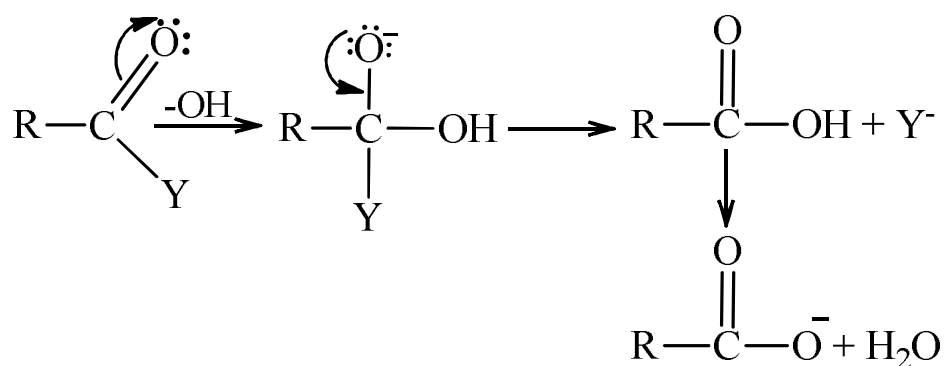

5. **By the action of carbon dioxide on alkyl of phenyl magnesium bromide:** Grignard reagent reacts with carbon dioxide forming an addition product which yields carboxylic acid on hydrolysis.

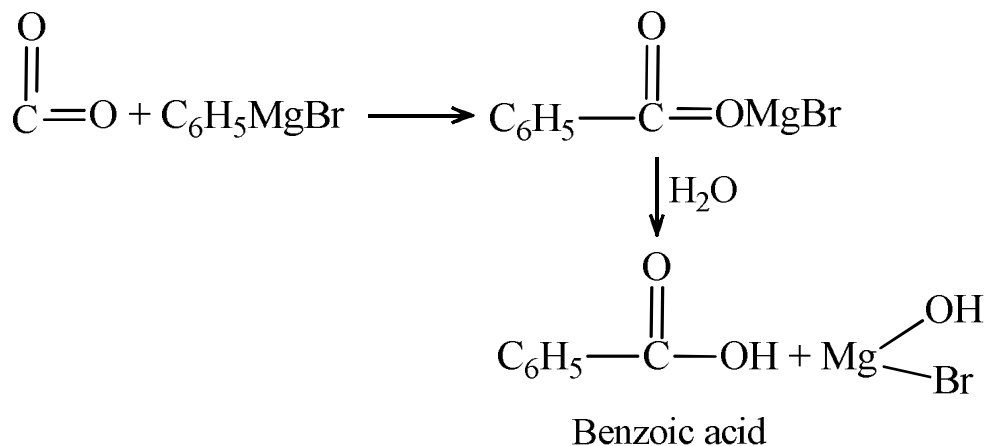
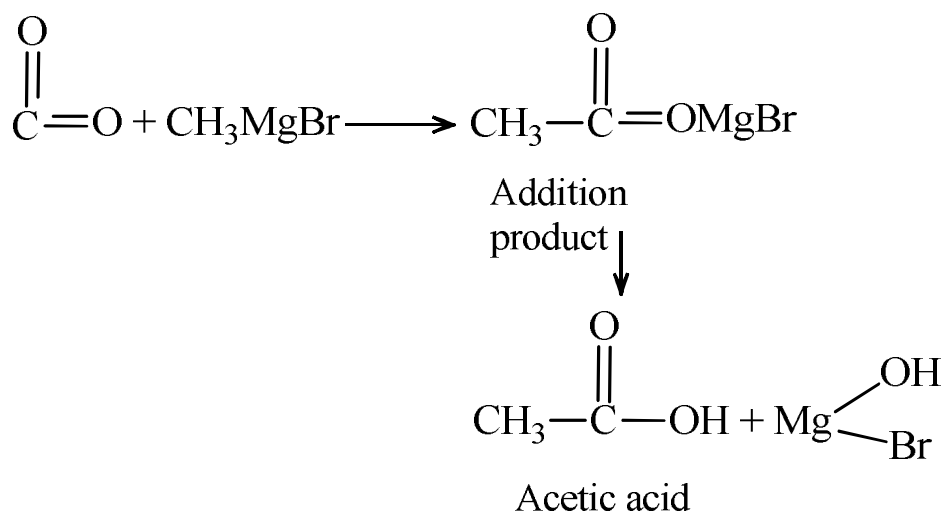

Mechanism: The nucleophile alkyl group is attached to carbon dioxide molecule whereas $-\text{MgBr}$ group is attached to one of the two oxygen atoms. This is shown schematically as under:

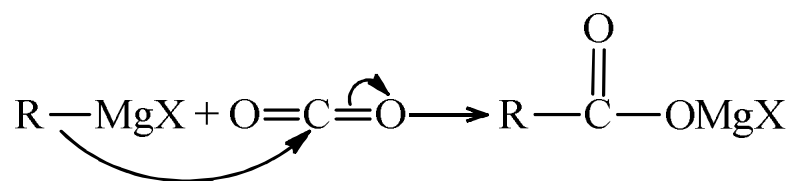

6. **By decarboxylation of dicarboxy acids:** Two carboxy groups attached to the same carbon atom are unstable to heat and a molecule of water is lost.

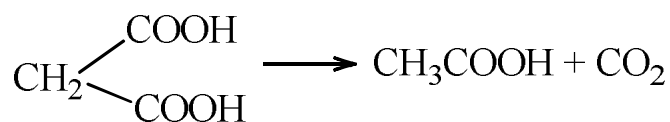
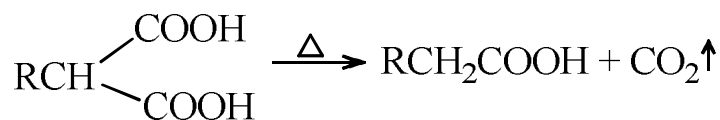

Malonic Acid

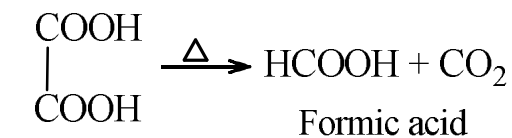

Formic acid

Oxalic Acid

7. **By hydrolysis of trihalogen compounds:**

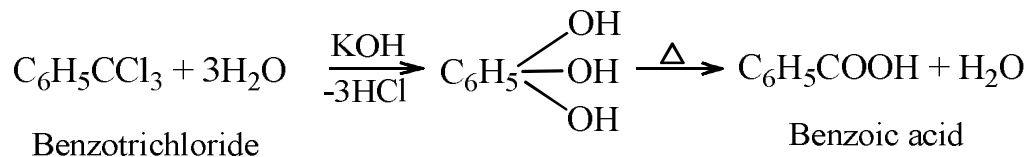
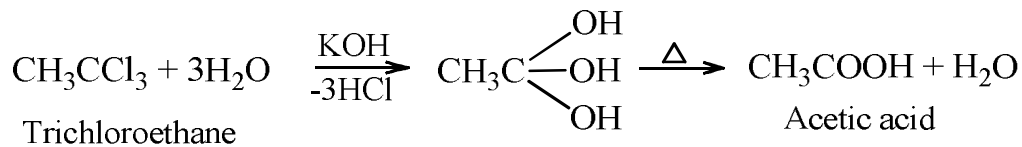
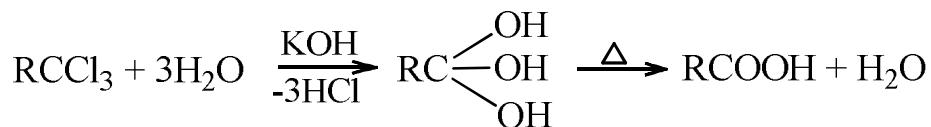

8. **From Malonic ester and Acetoacetic ester. Malonic ester synthesis:** A desired acid can be prepared from malonic ester having the formula

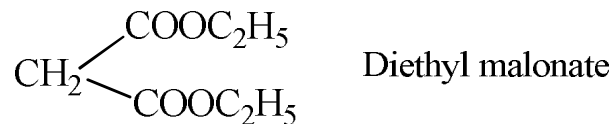

It involves the following steps:

- 1) Diethyl molecule is treated with sodium ethoxide to produce sodium malonic ester.



- 2) Sodium malonic ester is then treated with an appropriate alkyl halide to produce alkyl malonic ester.

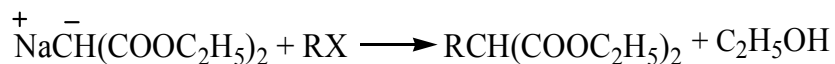

- 3) Alkyl malonic ester is hydrolysed and heated to produce carboxylic acid.

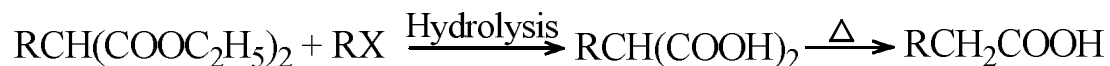

By a proper choice of the alkyl halide, any desired carboxylic acid can be produced

Acetoacetic ester synthesis: Like malonic ester, acetoacetic ester also possesses an α -hydrogen atom. This α -hydrogen can be replaced by sodium to produce sodium acetoacetic ester, which is then treated with an alkyl halide.

The addition product so obtained is subjected to alkaline hydrolysis to produce acids.

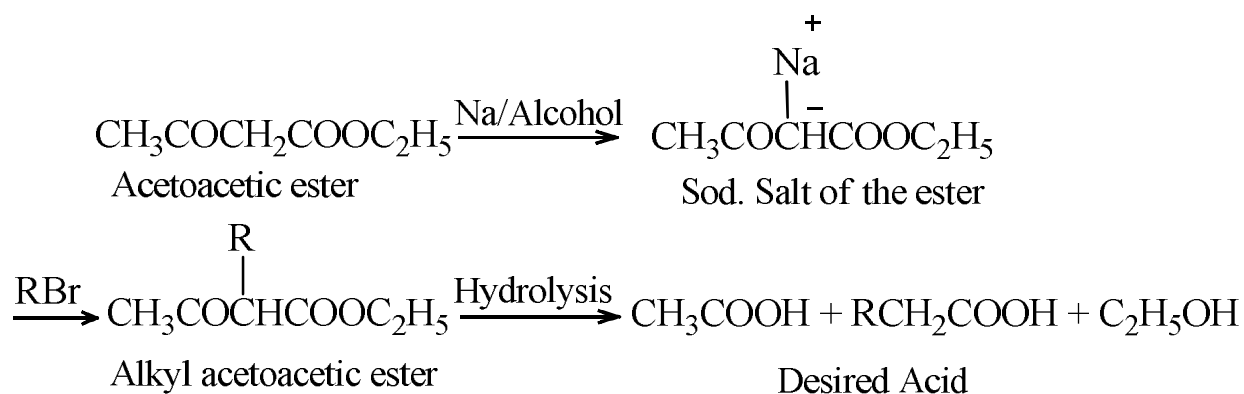

A proper choice of the alkyl halide is required in order to obtain a particular acid. For example to obtain propionic acid the alkyl halide needed is methyl bromide, to obtain valeric acid, the alkyl halide to be used is n-butyl bromide and so on.

5.4 Structure of Carboxylic Acid

Carboxy acid is represented as:

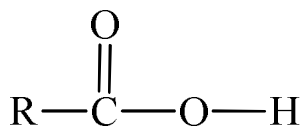

Where R is an alkyl or aryl group. The carboxyl group actually exhibits resonance. The two resonating structures of carboxy group are:

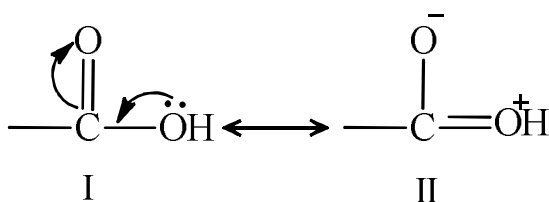

Structure II it is not so stable energetically because of the separation of charges. It does not contribute much to the actual structure of the carboxylic group. Thus the two structures do not contribute equally to the actual structure. Consequently, resonance energy, which estimates the stability of a compound, is less. On the other hand, the carboxylate ion obtained after removing one hydrogen atom is much more stable.

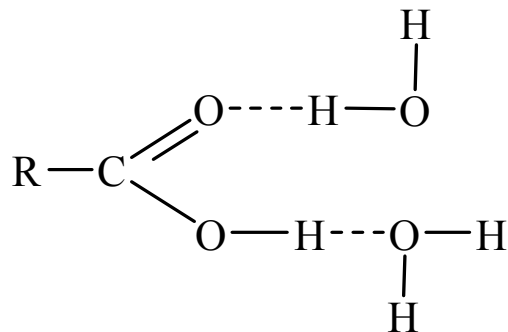

However, the solubility in water decreases gradually with the increase in the size of alkyl group. The bulky alkyl group tends to mask the carboxyl group which takes part in the hydrogen bonding.

Aromatic acids have little solubility in water. Both aliphatic and aromatic carboxylic acids are soluble in organic solvents like benzene, alcohol, ether, etc.

4. **Boiling points:** Monocarboxylic acids have higher boiling points compared to the alcohols of comparable molecular masses. For example, both n-propyl alcohol and acetic acid have molecular mass equal to 60. While alcohol boils at 370 K, the b.p of the acid is about 391 K. The higher boiling point of the acid as compared to that alcohol is due to the greater extent of intermolecular hydrogen bonding in the former compared to the latter as shown below:

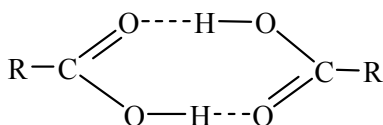

Hydrogen bonding
in carboxylic acids

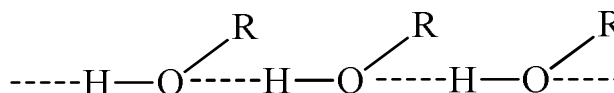

Hydrogen bonding
in alcohols

Most of the carboxylic acids exist as dimers, i.e, two molecules of carboxylic acids are linked by strong hydrogen bonds. This has been confirmed by the determination of molecular mass of acetic acid in freezing point method. The molecular mass is found 120 whereas in the monomeric state, the molecular mass of the acid is only 60.

The boiling point increases with the increase in the molecular mass. As the size of the alkyl group increases, the magnitude of the attractive forces (Van der Waals forces) increases causing an increase in boiling point.

The boiling points of a few monocarboxylic acids are given below:

Acid	HCOOH	CH ₃ COOH	C ₂ H ₅ COOH	C ₃ H ₇ COOH
Boiling Point (K)	373	391	424	437

The boiling points of the aromatic acids are higher than those of aliphatic acids due to greater size of the phenyl group as compared to that of the alkyl group.

5. **Melting points:** X-ray diffraction studies have shown that acid containing an even number of carbon atoms have higher melting points compared to the immediately next lower and higher members in the family which contain an odd number of carbon atoms. This is evident from the melting point data

Acid	CH ₃ CH ₂ COOH (3 carbons)	CH ₃ CH ₂ CH ₂ COOH (4 carbons)	CH ₃ CH ₂ CH ₂ CH ₂ COOH (5 carbons)
B.P (K)	251	267	239

The X-ray diffraction studies have revealed the acids with an even number of carbon atoms have carboxyl groups and terminal methyl groups on the opposite sides while those with odd numbers of carbon atoms have these groups on the same side.

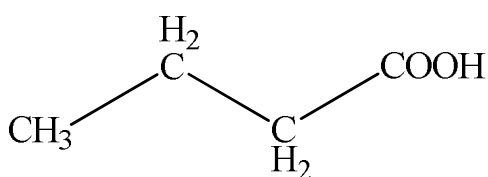

(Terminal groups are on the opposite side)

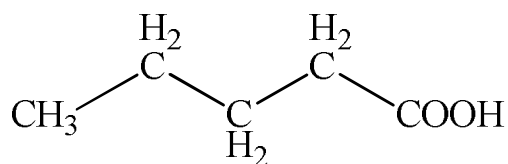

(Terminal groups are on the same side)

There are greater attractive forces between the molecules in acids containing an even number of carbon atoms because the molecules with an even number of carbon atoms fits into the crystal lattice better than the molecules with an odd number of carbon atoms. The melting points of the former are, therefore, higher.

This trend is, however, limited two members having up to ten carbon atoms. In higher members, the melting point generally increases with increase in molecular mass.

The melting and boiling points of some typical monocarboxylic acids are given in table 5.2.

Table 5.2. Melting and boiling points of some monocarboxylic acids

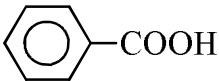
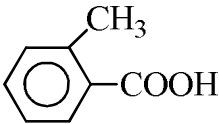
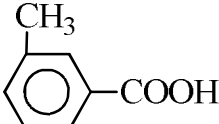
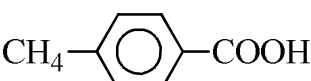
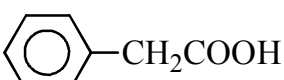
Compound	Formula	M.P (K)	B.P (K)
Formic acid	HCOOH	281	373
Acetic acid	CH ₃ COOH	289	391
Propionic acid	CH ₃ CH ₂ COOH	251	424
Butyric acid	CH ₃ CH ₂ CH ₂ COOH	267	437
Isobutyric acid	$\begin{array}{c} \text{CH}_3 \\ \\ \text{H}_3\text{C}-\text{CH}-\text{COOH} \end{array}$	226	427
Valeric acid	CH ₃ CH ₂ CH ₂ CH ₂ COOH	239	460
Isovaleric acid	$\begin{array}{c} \text{CH}_3 \\ \\ \text{CH}_3-\text{CH}-\text{CH}_2\text{COOH} \end{array}$	235	449
Caproic acid	CH ₃ -(CH ₂) ₄ -COOH	270	578
Palmitic acid	CH ₃ -(CH ₂) ₁₄ -COOH	336	625
Benzoic acid		395	523
o-Toluic acid		379	532
m-Toluic acid		385	536
p-Toluic acid		433	548
Phenylacetic acid		350	539

5.6 Chemical Properties of Carboxylic Acids

- A. **Reactions due to H-Atom two of the carboxyl (group properties due to ionizable hydrogen):** The hydroxyl group, which is a part of the carboxylic group, has ionizable hydrogen. This is because of the electronic change that takes place as shown below.

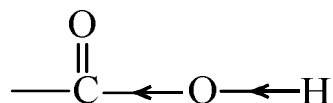

- 1) **Acidic nature:** Carboxy compounds turn blue litmus red. This is indicative of acidic nature of the group.

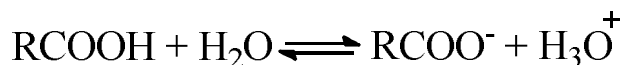

- 2) **Liberation of hydrogen:** Electropositive elements like Na, K and Ca react with carboxylic acids to produce hydrogen gas with the formation of the salt.

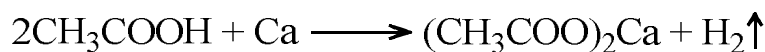
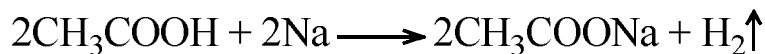

- 3) **Salt formation:** Carboxy acids react with alkalis and metallic oxides and decompose bicarbonates with the formation of salts. Reaction takes place also with ammonia.

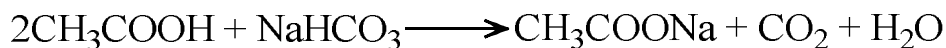
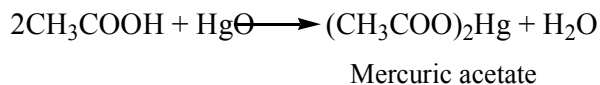
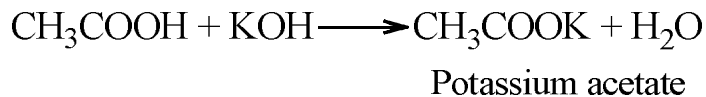

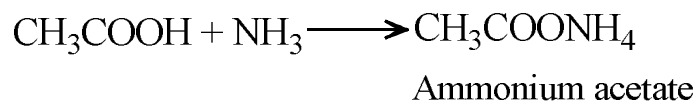

B. Properties involving replacement of hydroxyl group:

The -OH group of the acid can be replaced by -OR, -Cl, -NH₂ and -OOCR group to form esters, acid chlorides, amides and anhydrides respectively. These reactions are given separately as under:

I. Reactions with alcohols (formation of esters).

Carboxylic acids on heating with an alcohol in the presence of a strong mineral acid (such as H₂SO₄) form esters. This reaction is known as esterification and is reversible in nature.

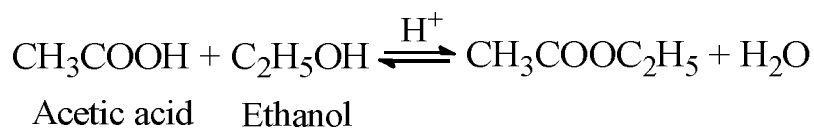
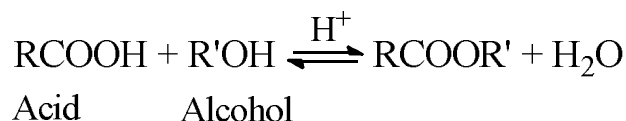

Mechanism: H⁺ from the mineral acid protonates oxygen. As a result, carbon atom becomes positive and undergoes nucleophilic attack by the alcohol molecule. Finally ester is obtained as depicted below:

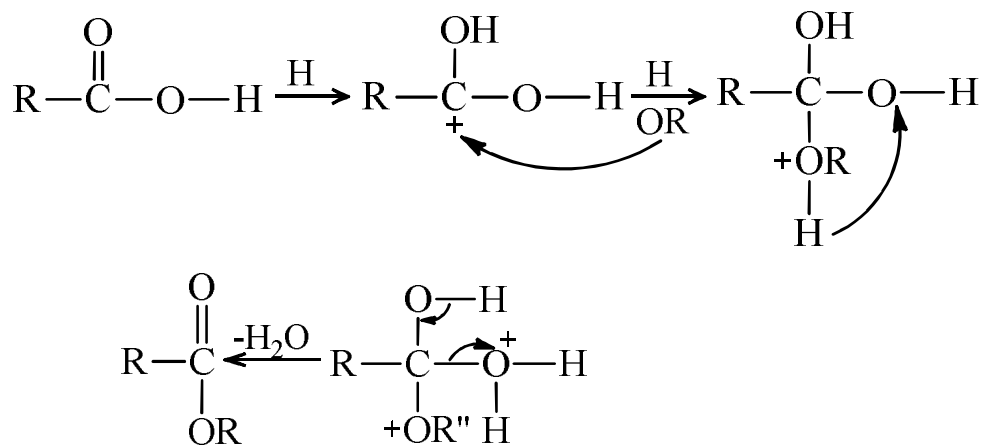

To summarise, esterification involves the cleavage of O–H bond of alcohol of C–OH of bond of the carboxylic acid. Thus,

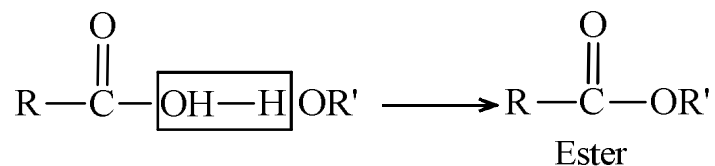

This has been confirmed by radioactive tracer studies.

For example, when benzoic acid is esterified with methyl alcohol containing O¹⁸ oxygen (labelled alcohol); the labelled oxygen after the reaction is present in the ester and not water.

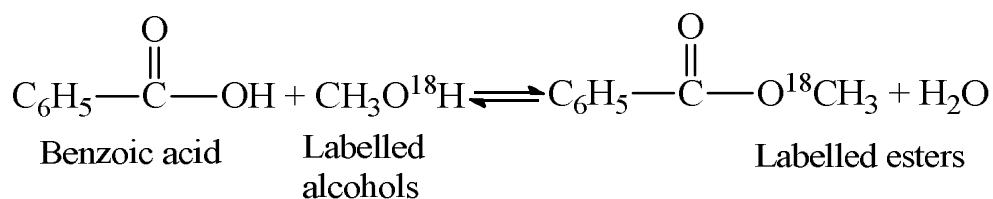

Had water been labelled, then OH part of alcohol and H atom of carboxyl group might have been involved which, of course, is not the case. This technique of studying the mechanism of a reaction is known as isotopic labeling.

II. Reaction with PCl₅, PCl₃ or SOCl₂ (Formation of acid chloride): An acid chloride is obtained when an acid is treated with PCl₅ or SOCl₂ (Thionyl chloride).

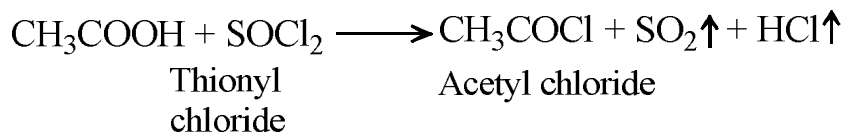
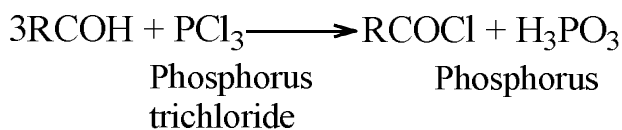
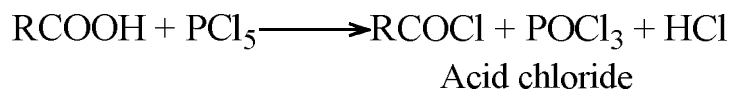

But of the above-mentioned reagents, thionyl chloride is preferred because the side products SO_2 and HCl escape. So we do not need to carry out fractional distillation to extract the main product.

Mechanism: The mechanism involved the nucleophile attack of the carboxylic acid on the Phosphorus atom of phosphorus halide on sulphur atom thionyl chloride as follows:

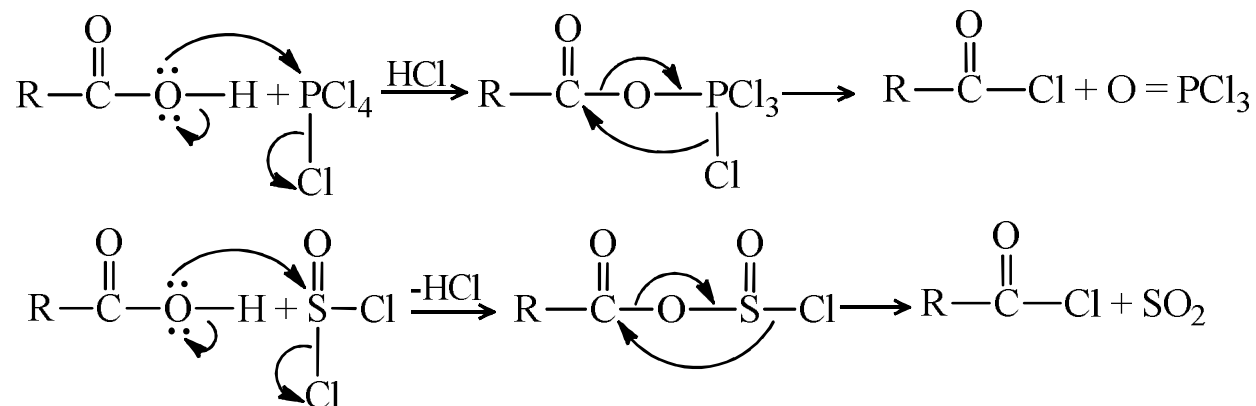

III. Reaction with ammonia (formation of acid amides): Ammonia reacts with acids to form ammonium salts which on heating liberate a water molecule giving amides.

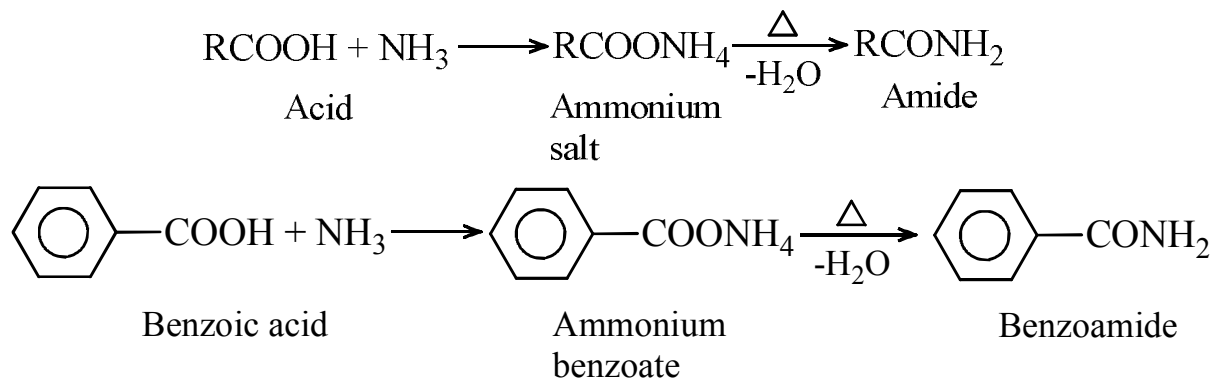

IV. Formation of acid anhydride: When the vapours of a carboxylic acid are passed over P_2O_5 , one molecule of water is eliminated from two molecules of acid resulting in the formation of acid anhydride.

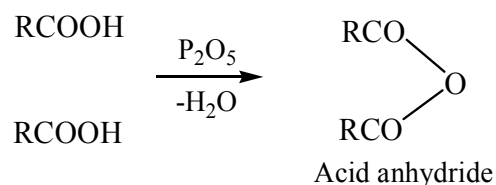

Mechanism: The reaction is supposed to proceed by the following mechanism:

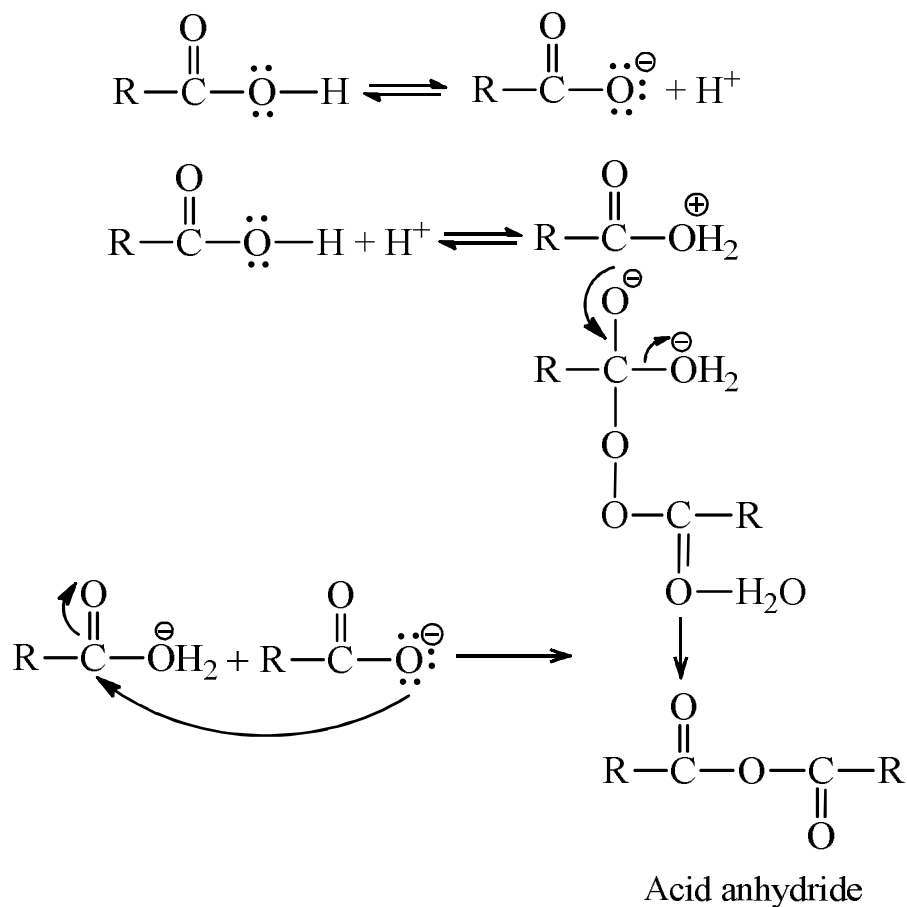

An anhydride can also be obtained by treating an acid with an acid chloride in the presence of pyridine which removes HCl molecules from the mixture.

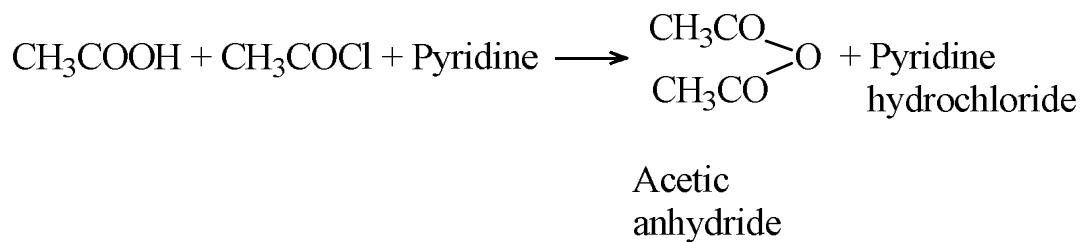

Mechanism:

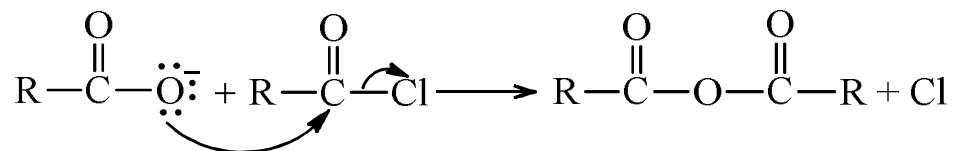

C. Reactions involving carbonyl (>C=O) group of carboxylic acids.

Carboxylic acids undergo reduction in the presence of lithium hydride to give primary alcohols.

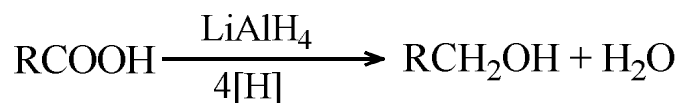

The reduction can also be brought about by first converting the carboxy compounds into ester followed by reduction.

This is found to be more convenient.

Reduction in this manner is known as **Beauveault Blane** reaction.

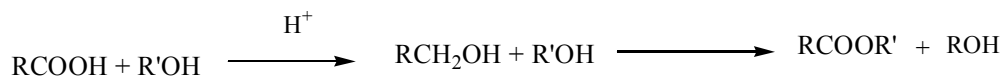

Mechanism: The reduction by lithium aluminium hydrides received by the transfer of hydride ion (H^-) as follows:



The carboxylic acid is initially reduced to aldehyde as follows:

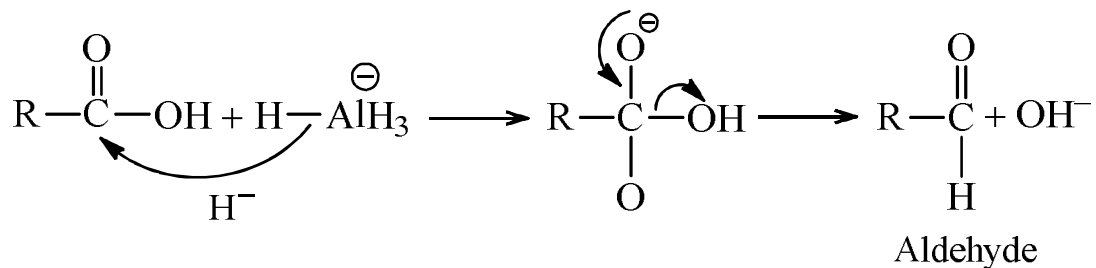

The aldehyde is then further reduced to primary alcohol as follows:

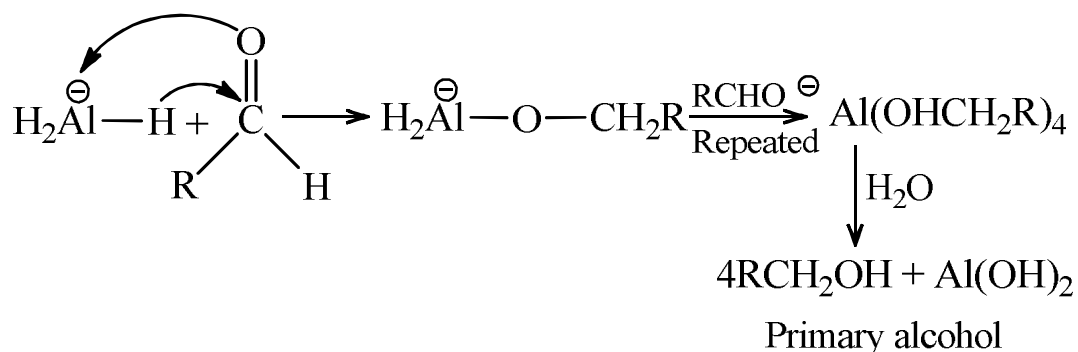

D. Reactions due to carboxyl group

- Decarboxylation of carboxylic acids:** carboxylic acid is decomposed if heated in the presence of soda- lime. The reaction takes place in two steps:

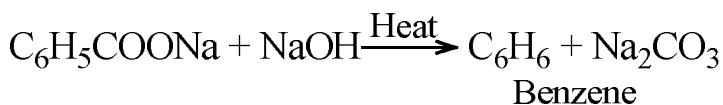
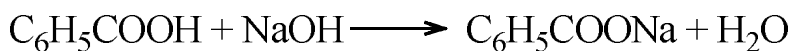
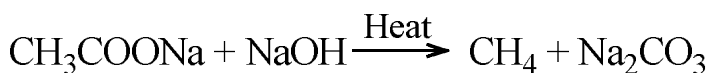

Carboxylic acid containing electron withdrawing groups such as $-\text{NO}_2$ or $\text{CH}_3\text{CO}-$ gets decarboxylated by heating alone. Thus,

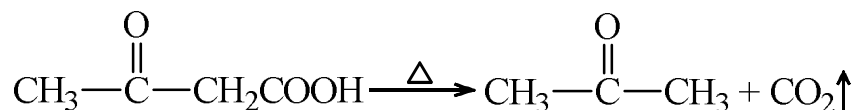

Mechanism: The mechanism involves the loss of a molecule of CO_2 from carboxylate anion as follows:

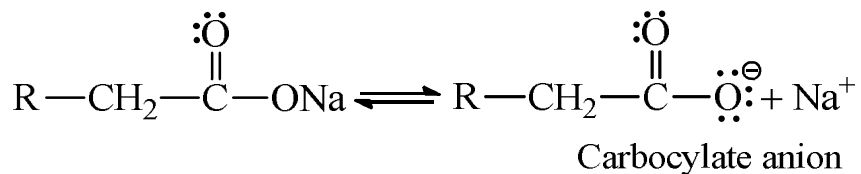

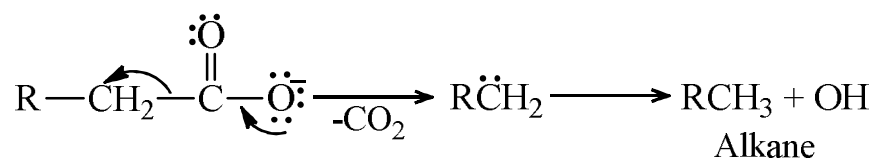

2. **Kalbe's electrolytic reaction:** If an electric current is passed through an aqua solution of alkali salt of carboxy acid, we obtain hydrocarbons

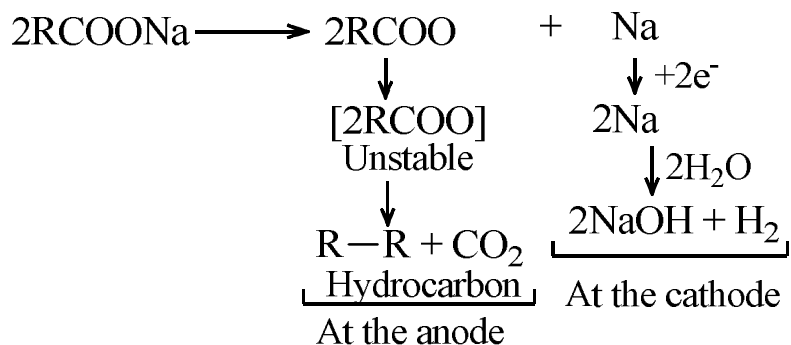

Thus, if we take Sodium Acetate is the salt; the hydrocarbon produced will be ethane.

3. **Hunsdiecker reaction:** In this reaction, silver salt of the carboxylic acid reacts with bromine in the presence of dry carbon tetrachloride to form alkyl Bromide as the product.

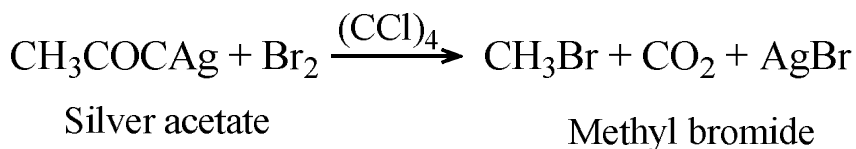

The reaction is called Hunsdiecker Reaction.

Mechanism of the reaction: The mechanism involves the initial electrophile attack of Br^+ on carboxylate Ion of the Silver salt.

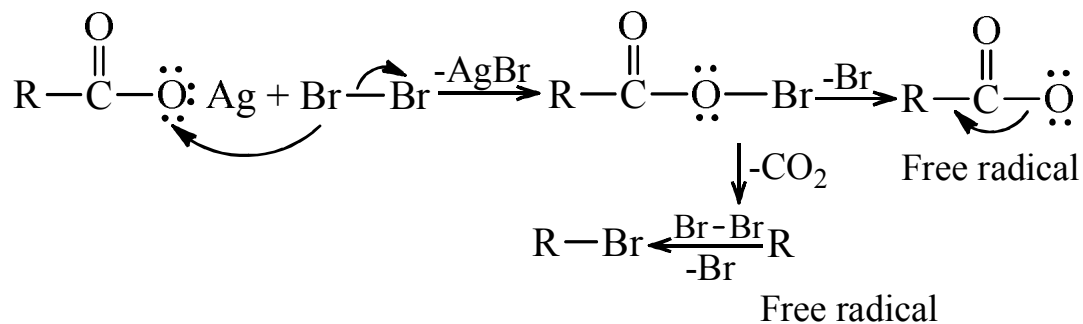

4. **Distillation of calcium salt:** Calcium salts of carboxylic acid on distillation form aldehydes and ketones.

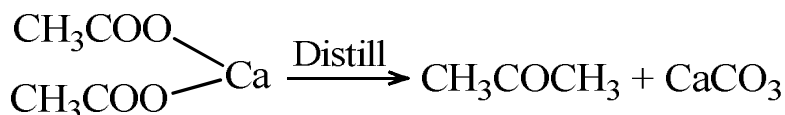
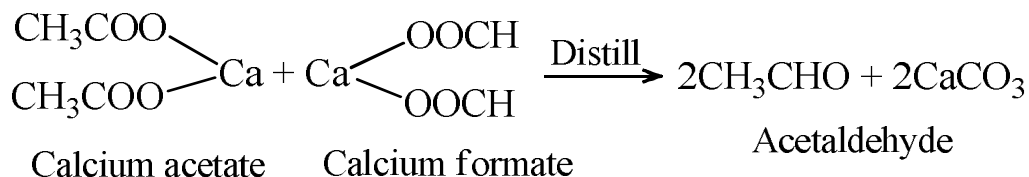
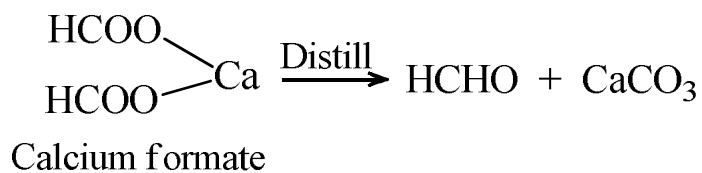

E. Halogenation of carboxylic acid

In the presence of a small amount of red phosphorus, Alpha hydrogen atoms of the alkyl group are replaced by chlorine or bromine to form Alpha halogen acids. This reaction is known as **Hell-Volhard-Zelinsky** (Abbreviated as HVZ) reaction.

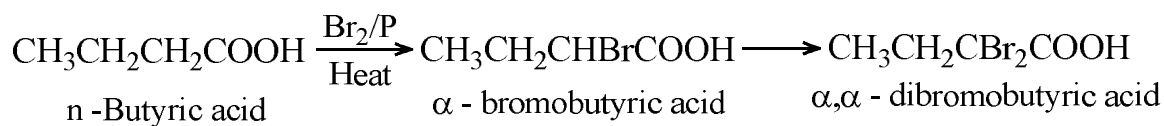

Halogen substitution will take place as long as Alpha hydrogen atoms are available. It is worth mentioning that bromination cannot be carried out beyond Alpha position where as chlorination beyond Alpha position is possible provided on Alpha hydrogen atoms have been replaced by chlorine.

Mechanism of halogenation: The reaction is believed to take place by the following steps:

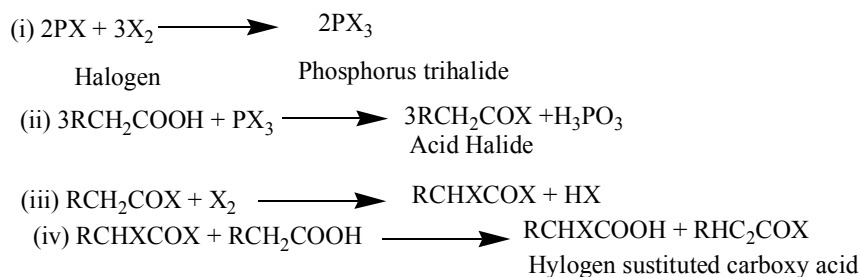

The C–X Bond in α -halo acid is highly reactive in nature. It can be cleaned very easily and the halogen atom gets replaced by number of nucleophiles leading to a variety of products.

Thus such a reaction is of great synthetic importance. The following examples illustrate:

1. **With aq. KOH:** α -hydroxy acids are formed

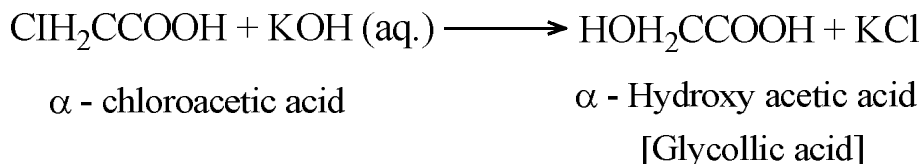

2. **With alcoholic ammonia:** α -amino acids are formed

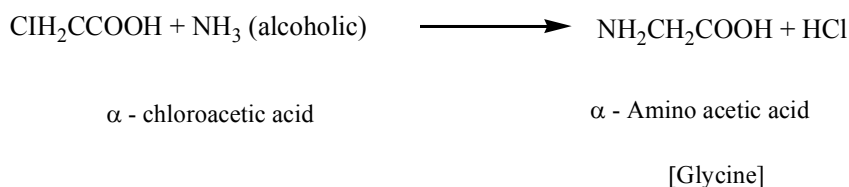

3. **With alcoholic KCN followed by acid hydrolysis:** Dicarboxylic acids are formed.

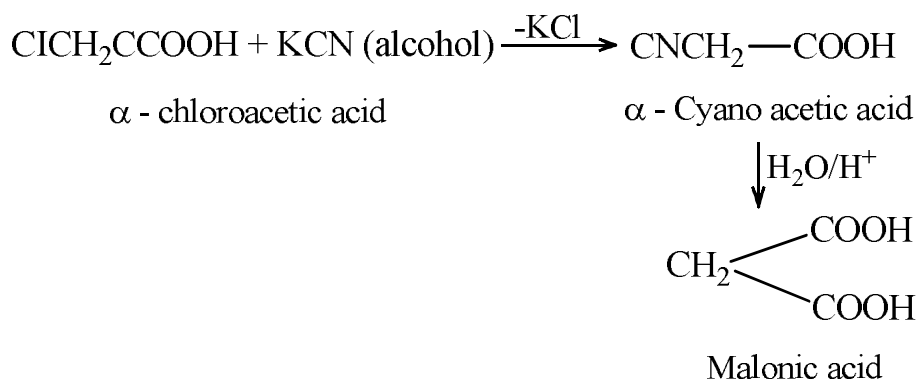

F. Reactions of Benzene Ring in Aromatic Acids

Aromatic acids give the usual replacement reaction of the benzene ring .i.e. halogenation, nitration, sulphonation etc. The mechanism is electrophilic in nature. The carboxyl (–COOH) group shows conjugation and as a result the ortho and para position in the ring gets positively charged.

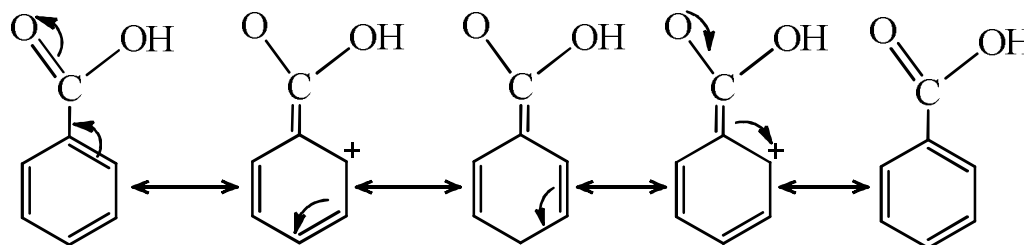

The Meta position in the ring is comparatively the centre of higher electron density. Therefore, distribution takes place at the Meta position in the ring. Since the ring has been deactivated due to the electron withdrawing nature of carboxyl group, today substitution reactions in the benzene ring takes place with difficulty. Nitration, sulphonation and halogenation reaction of benzoic acid are given below:

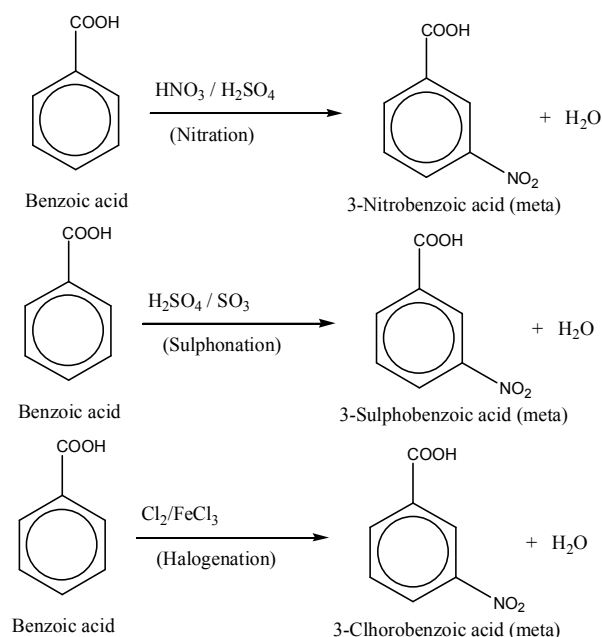

5.7 Acid Strength of Carboxylic Acids (Effect of substituents)

As explained earlier, carboxylic compounds are acidic in nature because they liberate carboxylate and hydrogen ions. Hydrogen ions do not exist as such but they are associated with water molecules as H₃O⁺ ion. Carboxylate ion is able to stabilize itself by resonance energy and this is the cause of strongly acidic nature of carboxylic compounds. The acid is dissociated as:

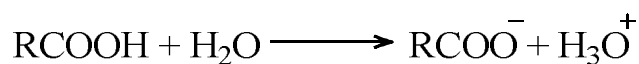

This is a reaction in equilibrium and according to the law of mass action, its equilibrium constant K_a, which may also be referred to as acidity constant, is given by the relation:

$$K_a = \frac{[\text{RCOO}^-][\text{H}_3\text{O}^+]}{[\text{RCOOH}][\text{H}_2\text{O}]}$$

The quantities within square brackets represent the molal concentration of the species. Since water exists in large quantities, its concentration almost remains constant and hence may be omitted. The equilibrium constant for acetic acid may be rewritten as:

$$K_a = \frac{[\text{CH}_3\text{COO}^-][\text{H}_3\text{O}^+]}{[\text{CH}_3\text{COOH}]}$$

The above equation shows that greater the value of $[\text{H}_3\text{O}^+]$, greater will be the value of K_a . It implies that a greater value of K_a signifies a stronger acid. Hence greater the value of K_a greater is the acid strength of the carboxy compound. Lately, there has been a practice to represent the strength of an acid in terms of $\text{p}K_a$ value which is related to K_a by the following equation:

$$\text{p}K_a = -\log K_a$$

Thus an acid having K_a value equal to 1.75×10^{-5} will have its $\text{p}K_a$ value as 4.75. It may be observed that $\text{p}K_a$ value changes inversely as the K_a value. Thus a strong acid will have a higher value of K_a but a similar value of $\text{p}K_a$.

Effect of Substituents on the Acid Strength

The strength of a Carboxylic compound changes when certain groups are introduced in at certain positions. As a matter of fact, we expect an increase in the acid strength if some electron withdrawing group is introduced in the molecule. A reverse effect is observed when the group introduced is electron releasing. If the extra group Attached is represented as -G, then the situation in the two cases can be represented as below:

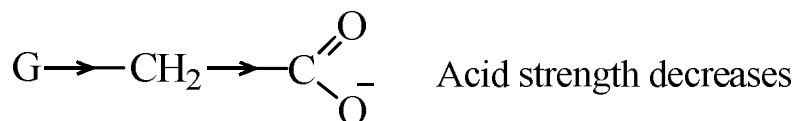
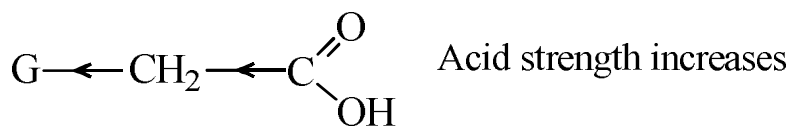

When an electron attracting group is attached, it will stabilize the carboxylate Ion to a greater extent by dissipating the negative charge. It will help in the release of more protons. In the case of an electron releasing group, there will be a greater concentration of negative charge on the carboxylate group which will ultimately reduce the stability of the carboxylate ion. Hence the liberation of protons will be suppressed. The effect of substituents on the acid strength can be studied under two headings”

1. **Aliphatic Acids:** The following observations are made here:

- a. Consider the case of acetic acid; it has a pK_a value of 4.75. If we replace of the hydrogens of the methyl group by halogen group an electron attracting group, the halogenations acid is found to have a lower value of pK_a i.e. it is found to be stronger than acetic acid. Further, the acid strength changes with halogen. As fluorine is more electronegative than chloroacetic acid which in turn is more acidic than bromoacetic acid.



- b. The increase in the acid strength of an acid depends upon the number of such electron withdrawing groups. Greater of electron withdrawing groups, greater is the strength of the acid.

Thus dichloroacetic acid is stronger than monochloroacetic acid and trichloroacetic acid is stronger than dichloroacetic acid.

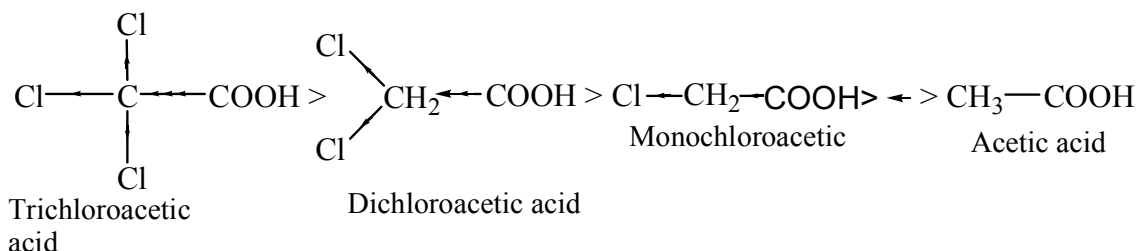

- c. The strength of the acid depends upon the position of the electron withdrawing group relative to the carboxyl group. Nearer the electron withdrawing group to the carboxyl group, the greater the acids strength. Thus Alpha propionic acid is stronger than beta chloropropionic acid.

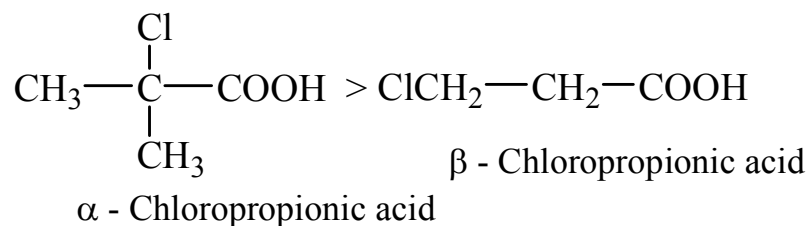

- d. Substitution of an electron releasing group in the carboxylic acid decreases the acid strength. Greater the number of such constituents, greater will be the effect.

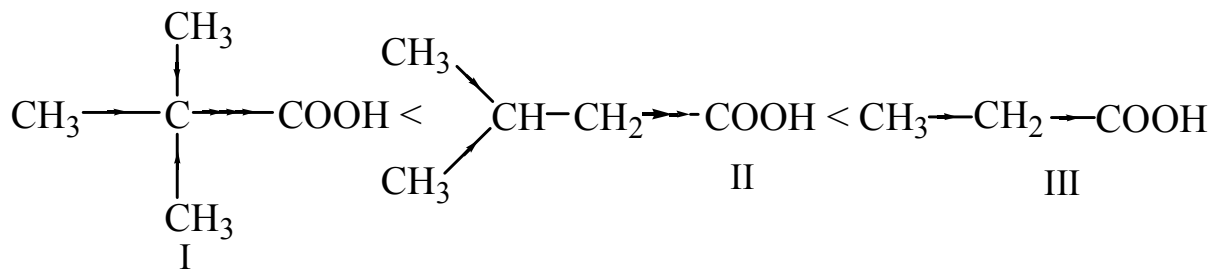

Thus, consider the above three compounds. Compounds will experience the maximum electron repelling effect as the three methyl groups I directly attached to carbon next to the carboxyl group. In compounds II and III, the number of methyl (or alkyl) groups attached to the carbon next to the carboxy group is 2 and 1 respectively. As a consequence compound III it will be the strongest acid and compound I the weakest series.

It may be mentioned that a propyl group will have a greater electron repelling effect than ethyl group which in turn will have greater repelling effect than methyl group. Thus, the first four homologues of carboxylic compounds have the strength in the following order:



2. Aromatic acids: The following observations are made here:

- a. Electron-withdrawing groups like $-\text{NO}_2$, $>\text{C}=\text{O}$, $-\text{CN}$, $-\text{Cl}$ when substituted into the benzene ring raise the strength of the acid by inductive effect and resonance effect. Resonance effect is known to be stronger than inductive effect. But the position where such groups are linked is more important. The above groups produce a positive charge at the ortho and para positions but not at the meta position as shown below:

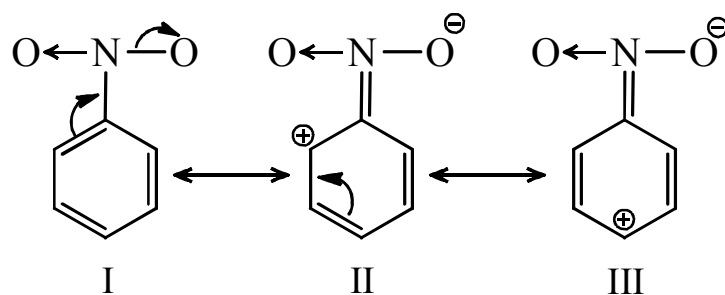

The positive charge at ortho and para positions help in the removal of proton from the carboxy group. Consequently o- and p- nitrobenzoic acids are stronger than m-nitrobenzoic acid. But m- nitrobenzoic acid is definitely stronger than benzoic acid as nitro group withdraws the electron, although not strongly, but inductive effect at the Meta position.

- b. Reverse is the case when electron donating group is linked to the benzene ring. Hydroxy group is an electron- donating group in the resonance phenomena as shown below:

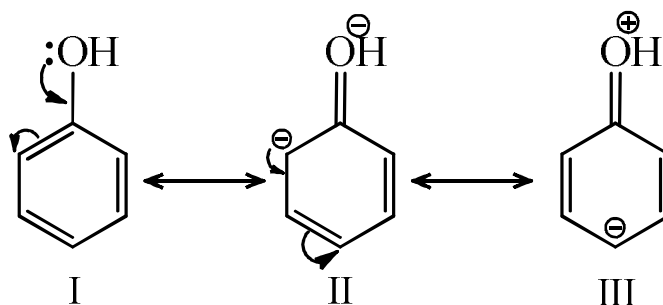

This para position, where the carboxyl group is attached, becomes negative. This will decrease the strength of p- hydroxybenzoic acid as compared to benzoic acid. But hydroxy group will produce a slight positive charge at the meta position due to the inductive effect. Thus m-hydroxybenzoic acid is stronger than benzoic acid. Ortho hydroxybenzoic acid, although against expectation, is a stronger acid than benzoic acid. As general observation, a group up in the ortho position always increases the acid strength. This is called ortho effect. Thus out of o-, m- and p- substituted benzoic acids. o- Compounds will be stronger acid. However, there is no satisfactory explanation for this effect. The K_a (dissociation constant) values of some substituted aromatic acids are given in the following table:

Table 5.3 Acidity constants (K_a) of substituted benzoic acids $(K_a \text{ of } C_6H_5COOH = 6.3 \times 10^{-5})$

Substituent (Nature)	K_a value at Para position	K_a value at Meta position	K_a value at Ortho position
CH ₃ (electron releasing)	4.3×10^{-5}	5.5×10^{-5}	12.5×10^{-5}
OCH ₃ (electron releasing)	3.2×10^{-5}	8.3×10^{-5}	8.2×10^{-5}
OH(electron releasing)	2.5×10^{-5}	8.5×10^{-5}	10.5×10^{-5}
Cl(electron releasing)	10.4×10^{-5}	15.5×10^{-5}	12.0×10^{-5}
NO ₂ (electron releasing)	35.0×10^{-5}	30.0×10^{-5}	60.0×10^{-5}

Halo Acids

Halogen substituted halo acids are compounds in which one or more hydrogen atoms of the hydrocarbon chain of carboxylic acid are replaced by corresponding number of halogen atoms.

5.8 Nomenclature of Halo Acids

Common system: Common names of halogen substituted acid (or halo acids) is derived from the common names of parent Carboxylic acids. The position of halogen atoms are inclined by Greek letters α, β, γ and δ etc. Where α is -ylic group next position being beta, still next position are gamma and Sigma.

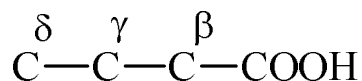

IUPAC system: in IUPAC system of nomenclature, the position of halogen is indicated by numerals - 1, 2, 3, 4, ..., number one being the position of carboxylic carbon atom.

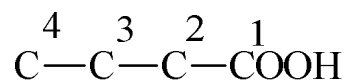

The common and IUPAC names of some halogen substituted acid are given in Table 5.4

Table 5.4 Common and IUPAC names of halogen acids

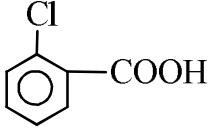
Halo acids	Common Name	IUPAC Name
ClCH_2COOH	Chloroacetic acid	Chloroethanoic acid
CH_3CHCOOH Cl	α -Chloropropionic acid	2-chloropropanoic acid
$\text{CH}_3\text{CHCH}_2\text{COOH}$ Br	β -Bromobutyric acid	3-Bromobutanoic acid
$\text{CH}_2\text{CH}_2\text{CH}_2\text{COOH}$ I	γ -Iodobutyric acid	4-Iodobutanoic acid
$\text{CH}_3\text{CHCHCH}_2\text{OOH}$ Br Br	α,β -Dibromobutyric acid	2,3-Dibromobutanoic acid
	α -Chlorobenzoic acid	2-Chlorobenzene carboxylic acid

5.9 Methods of preparation of Halo acids

General methods of preparation of Halo acids are given below:

- Hell-Volhard-Zelinsky Reaction (HVZ Reaction):** a hydrogen atom of a carboxylic acid can be replaced by halogen on treatment with the halogen in the presence of red phosphorus.

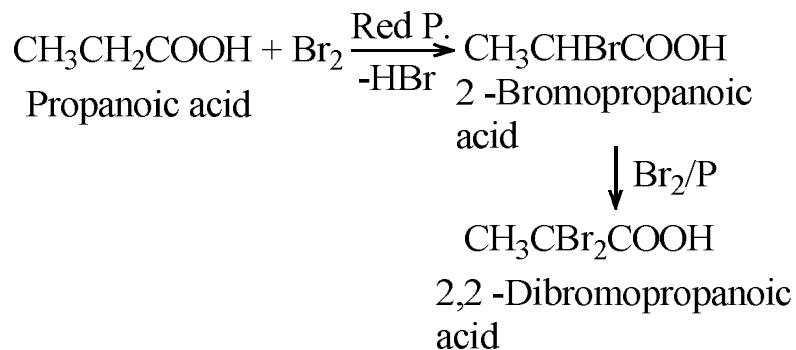

The substitution takes place at the Alpha position and the reaction can be stopped at a particular stage by using appropriate quantities of the halogen and phosphorus. It is observed that chlorination can take place beyond positions as well.

In the reaction between acetic and Cl_2 all the three hydrogen atoms can be successively replaced by chlorine.

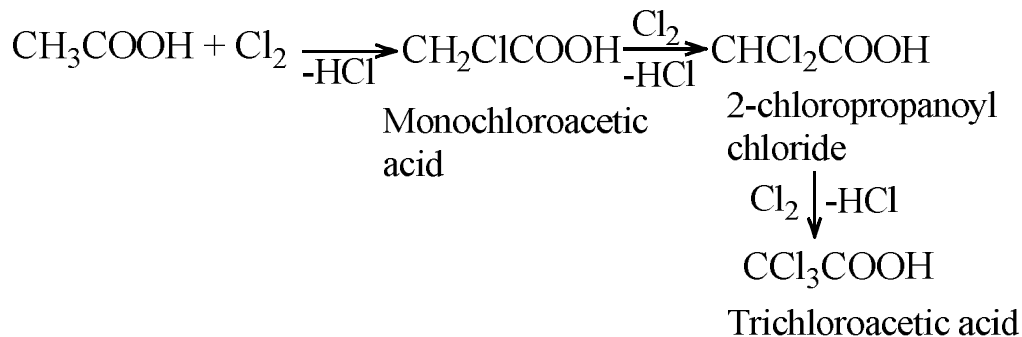

- Action of sulphuryl chloride on carboxylic acid:** Carboxylic on treatment with sulphuric chloride in the presence of Iodine yields halo acid.

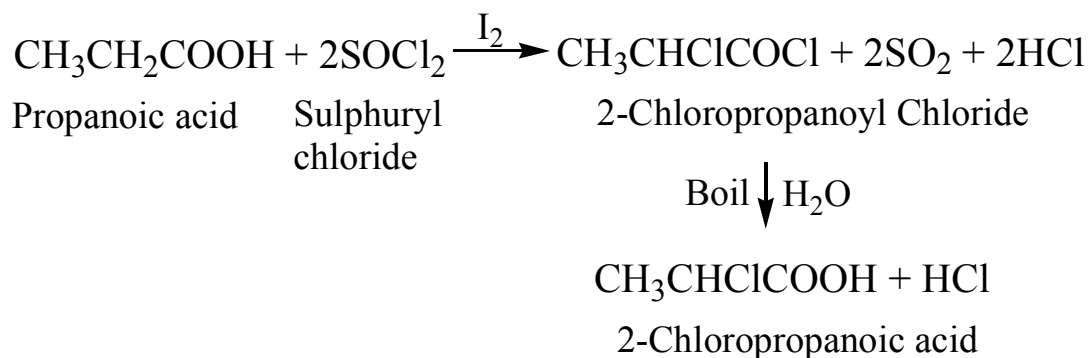

3. Halogenation of malonic acid and alkyl malonic acids:

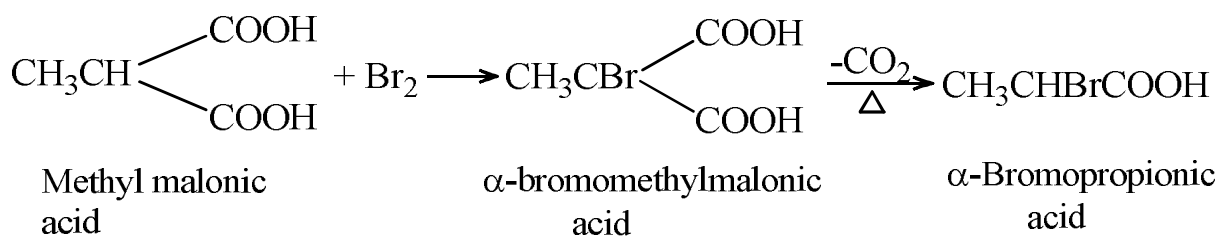
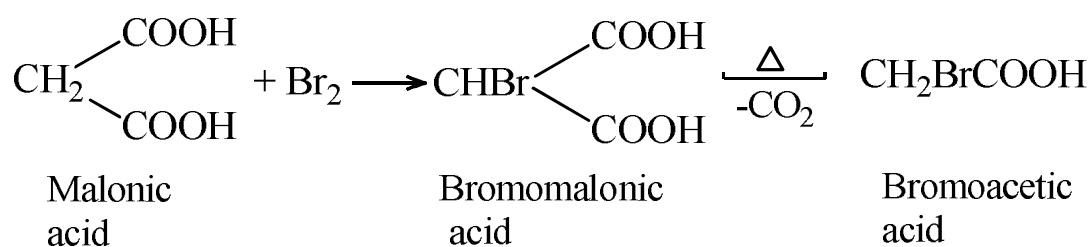

4. From Alpha hydroxy acids: Alpha hydroxy acid can be converted into Alpha Halo acids on treatment with halogen acids.

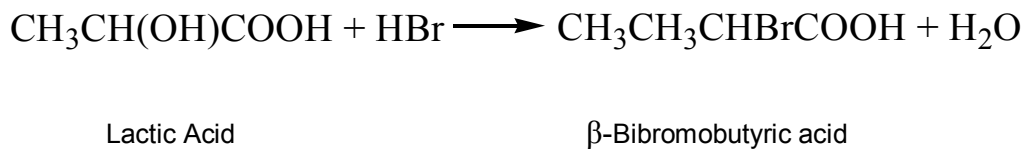

5. From α,β unsaturated Carboxylic acids: Such acids on addition of halogen and halogen acids produce halo acids as given below:

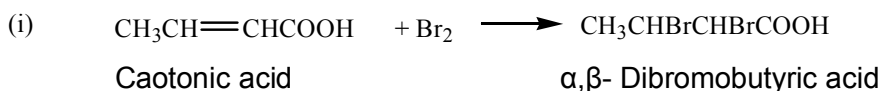

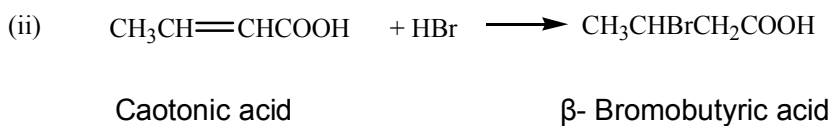

The affords us a method to prepare β-halo acids. It may be mentioned that in the above reaction

(iii) The addition of HBr to the double bond takes place contrary to Markovnikov rule. This is because of the electron withdrawing (-I) inductive effect of the carboxylic group. Consequently β-carbon becomes slightly positive and α-carbon becomes slightly negative. Therefore Br and H (of HBr) are attached to α and β positions respectively.

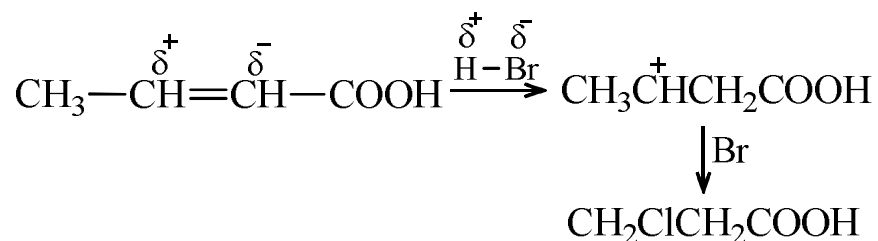

6. **From α,β unsaturated aldehydes:** Addition of halogen acid to α,β unsaturated aldehydes followed by oxidation yields β hydrogen acids.

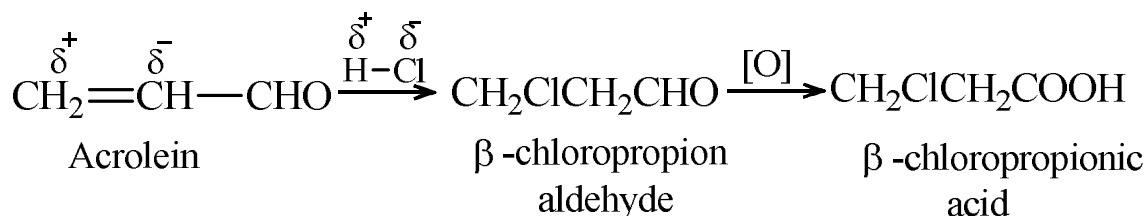

5.10 Properties of Halo acids

Halo acids give all the properties of the parent to carboxylic acid. In addition, they give the properties due to the Halogen group. Properties of halo acids are as follows:

1. **Acidic strength:** They show acidic properties due to the presence of carboxylic group in the molecule. In fact, the halo acids are more acidic than the normal has because of the inductive effect of halogen. Halogen withdraws the electrons towards itself, thereby helping in the release of protons.

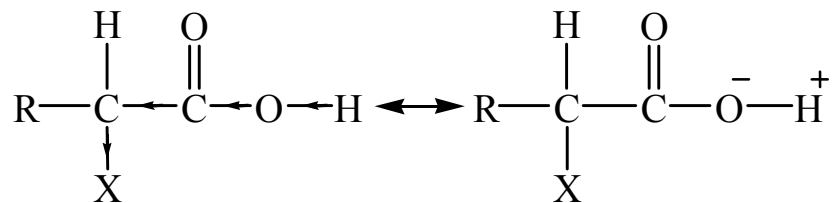

Following observations are made in this connection:

- a. Among various halo acids, chloro acids are stronger in acidic nature than bromo acids which are, in turn, stronger than iodo acids.

This is due to greater inductive effect of chlorine compared to bromine and greater effect of bromine compared to Iodine.

- b. For halo acids, having the same halogen atom the acid strength decreases as the position of halogen goes away from the carboxyl group. Thus 3- chloropropionic acid will be a weaker acid than 2- chloropropionic acid.

2. **Reactions due to the carboxylic group:** Origin of acid does not interfere in the reactions of carboxylic group and these properties are given in normal manner. Halo acids decompose carbonates and bicarbonates; react with alcohols to form ester with phosphorus pentachloride to form acid chlorides.

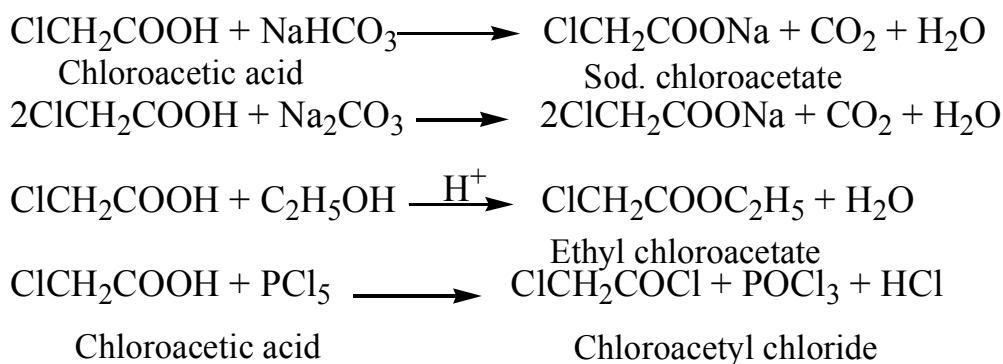

3. **Reactions due to the halogen atom:**

- a. **Action of alkalis:** Different products are obtained when halo acids are heated with aqueous solution of alkali, depending upon the position of halogen atom with respect to the carboxylic group.

α -Halo substituted acids give α -hydroxy acids on hydrolysis.

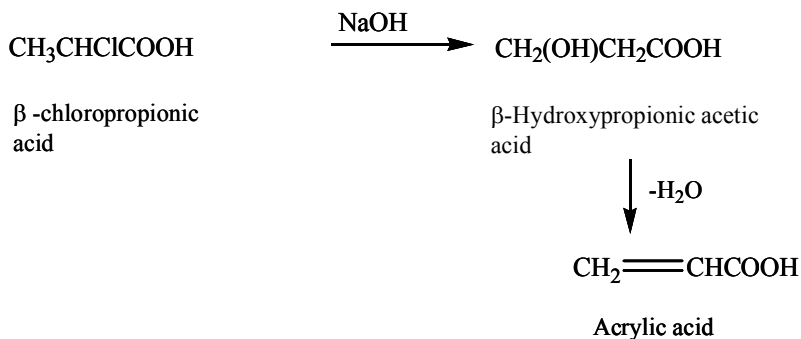
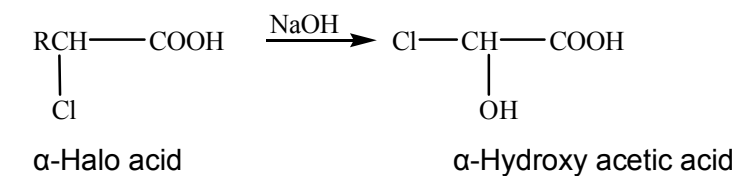

b. Nucleophilic substitution reactions: solution of the acid can be substituted by nucleophiles like CN^- , NH_3 , CH_3^-

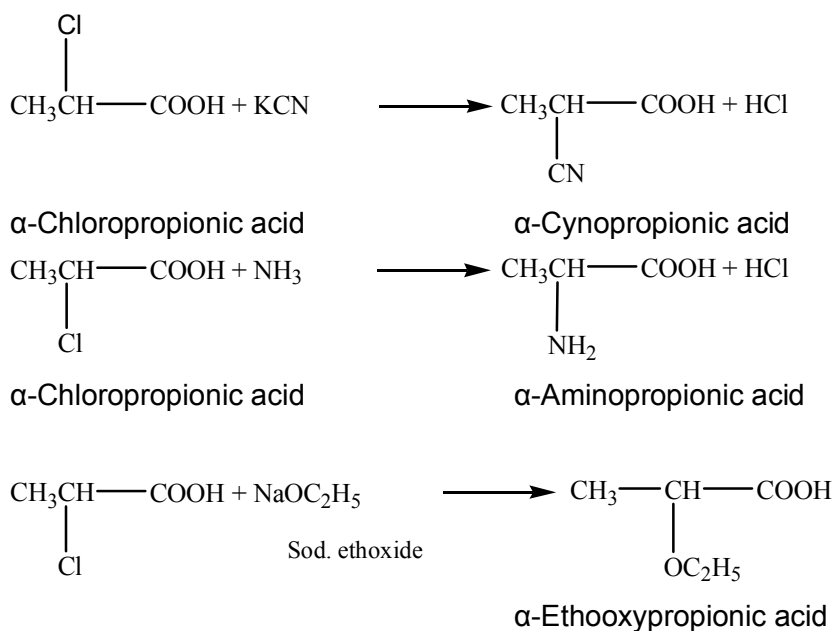

5.11 Hydroxy Acids

Nomenclature

A carboxylic acid with a hydroxy group in its hydrocarbon chain is called hydroxy acid. It can be obtained by substituting a hydrogen atom in its hydrocarbon chain by hydroxy group. Hydroxy group could be present in $\alpha, \beta, \gamma, \delta$ positions with respect to carboxylic group (according to common system) or 1,2,3,4 positions (according to our IUPAC system). The nomenclature of hydroxy acids is given in **Table 5.5**

Table 5.5 Common and IUPAC names of hydroxy acids

Hydroxy acid	Common name	IUPAC name
HOCH ₂ COOH	α -Hydroxyacetic acid (Glycollic acid)	Hydroxyethanoic acid
HOCH ₂ CH ₂ COOH	β -hydroxypropionic acid	3-hydroxypropanoic acid
CH ₃ CHOHCOOH	γ -hydroxypropionic acid (lactic acid)	2-hydroxypropanoic acid

5.12 Methods of preparation of hydroxy acids

A. Preparation of α -hydroxy acid

- a. **Hydrolysis of α -haloacids:** Hydrolysis of α -haloacids using alkali solution or moist Silver oxide yields α -hydroxy acids.

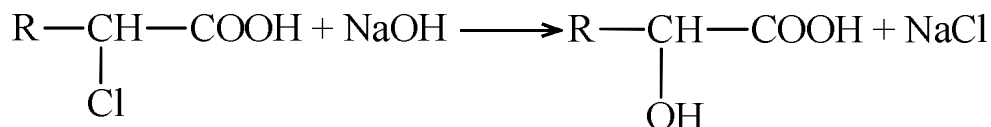

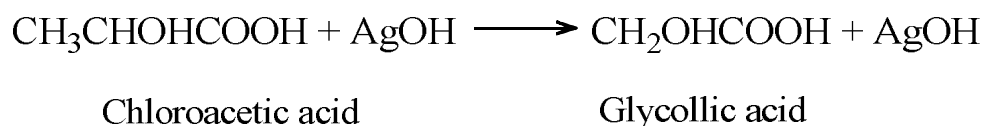
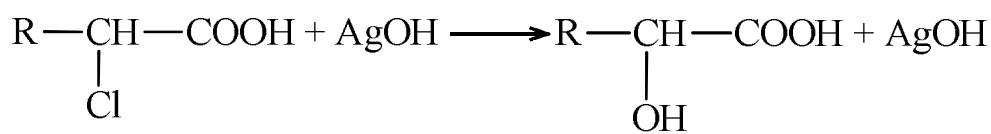

- b. Action of nitrous acids:** α -amino acid react with nitrous acid to produce α hydroxy acid. A mixture of sodium nitrate and hydrochloric acid yields the nitrous acid.

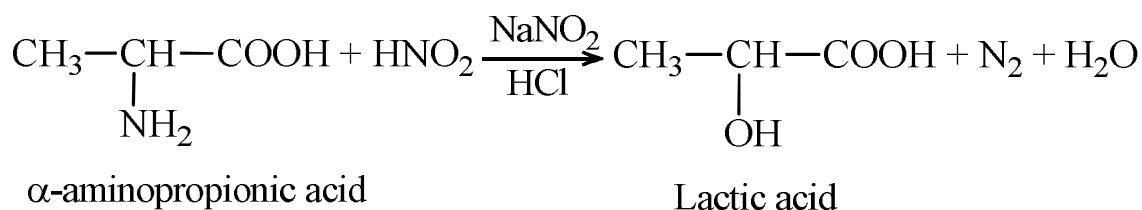

- c. Hydrolysis of cyanohydrin:** Cyanohydrin is obtained by the action of HCN on aldehydes and ketones. These are then hydrolysed in the presence of mineral acid to produce hydroxy acids.

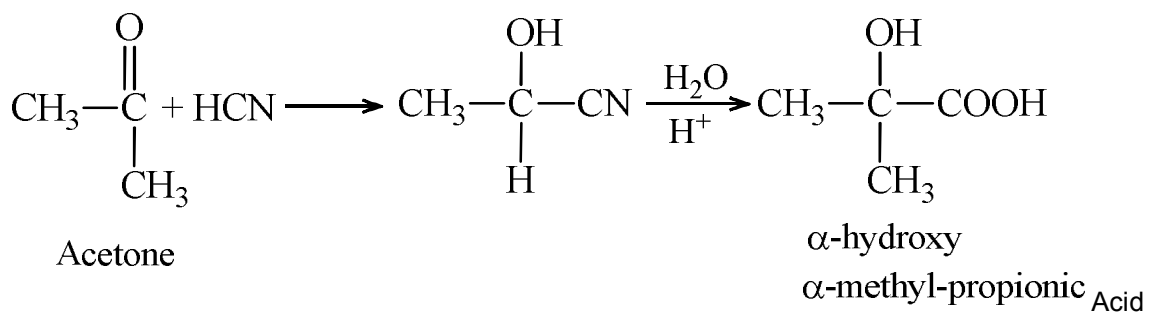
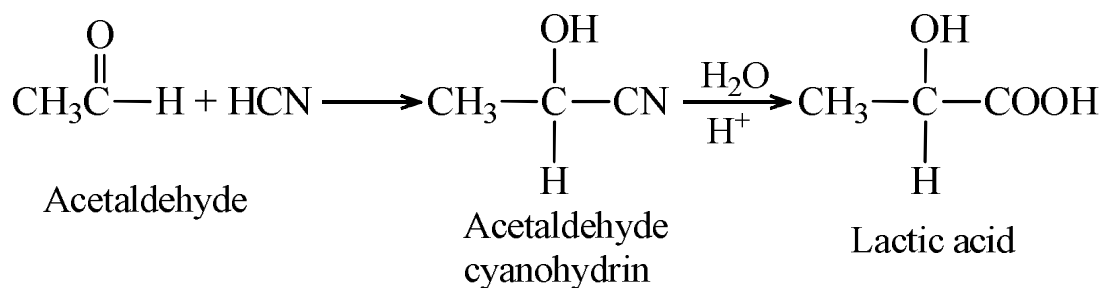

- d. **Reduction of Ketoacids:** Reduction of keto acid with sodium amalgam yields hydroxy acid.

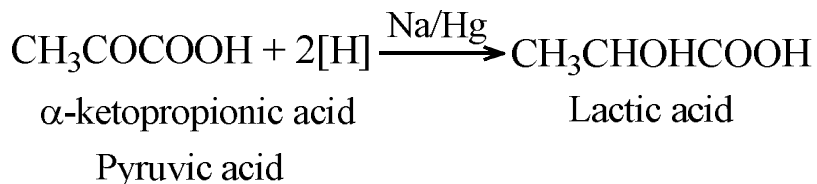

- e. **Oxidation of 1, 2 dihydroxy compounds:** 1, 2 dihydroxy compounds of the following type upon oxidation with suitable oxidizing agent give hydroxy acids.

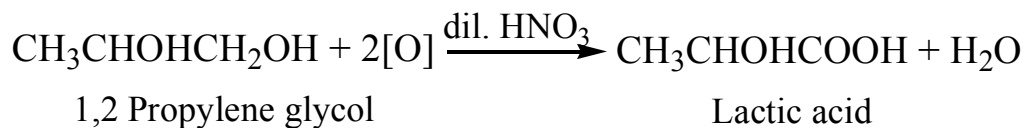
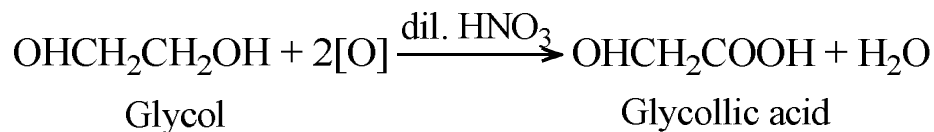

B. Preparation of β -amino hydroxy acids

- a. **Action of HNO_2 :** β -amino acid reacts with nitrous acid to produce β -hydroxy acid

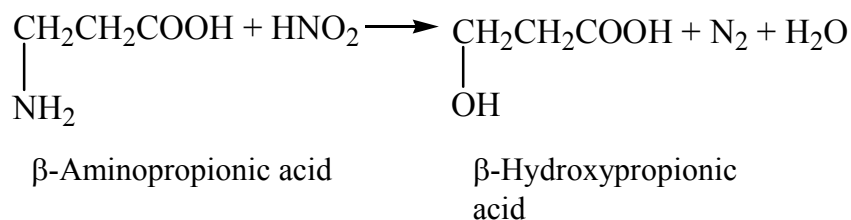

- b. **From chlorohydrin:** A chlorohydrin is treated with potassium cyanide and then hydrolysed with water.

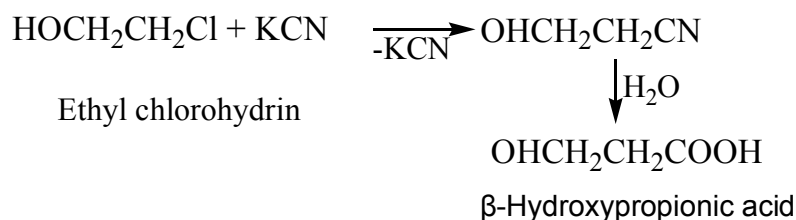

c. Oxidation of 1,3 of dihydroxy compounds

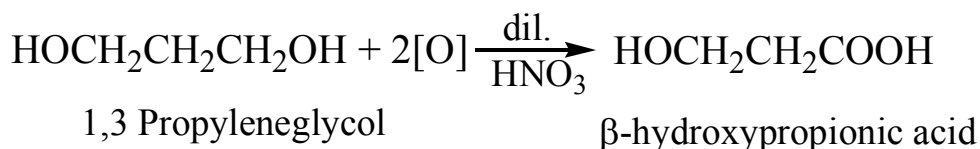

d. Reformtsky reaction: An aldehyde or ketone is treated with α -bromoester and Zinc metal in ethereal solution. The addition product initially formed is hydrolysed by dilute mineral acid to yield β -hydroxy acid.

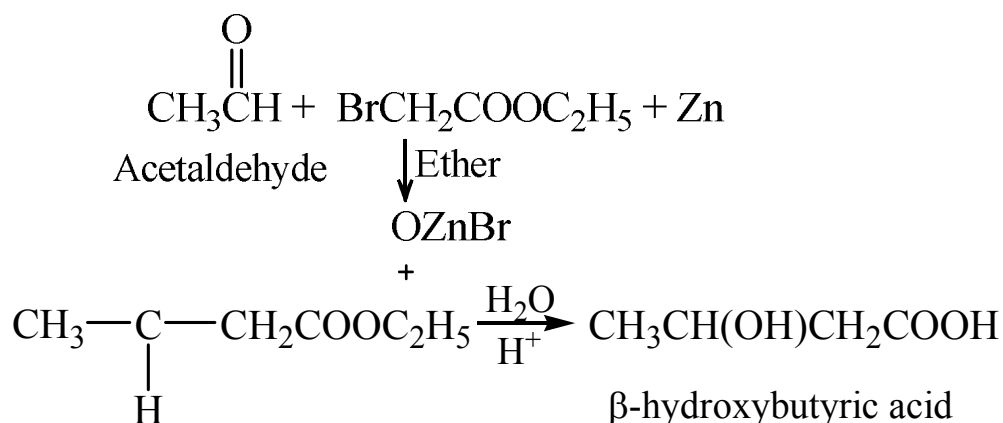

5.13 Properties of hydroxy acid

Properties of hydroxy acids are described below:

- Solubility:** Hydroxy acids are soluble in water. This is because of the presence of hydroxy and Carboxylic group both of which form hydrogen bonds with water.
- Reaction with acetyl chloride:** Acetyl derivatives of hydroxy acids are obtained on treatment with acetyl chloride or acetic anhydride.

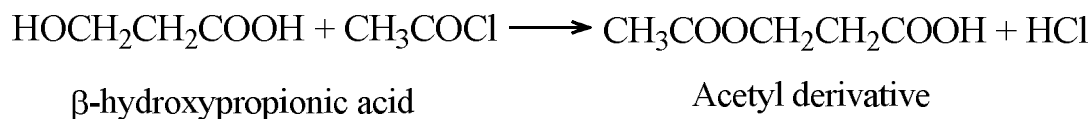
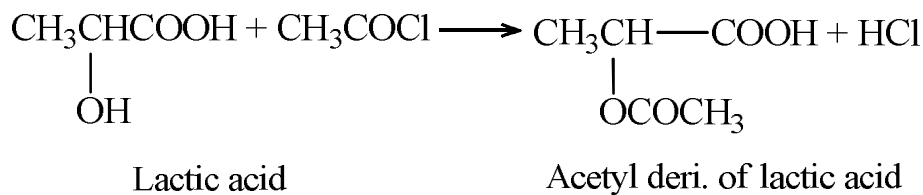

3. **Oxidation:** Hydroxyl group of the hydroxy acid is oxidised to aldehyde or Ketone group (as the case may be).

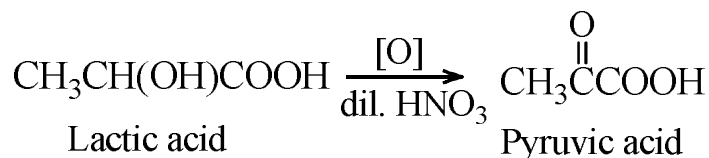

4. **Reduction:** On heating with hydroiodic acid, hydroxy acids are reduced to the parent acids.

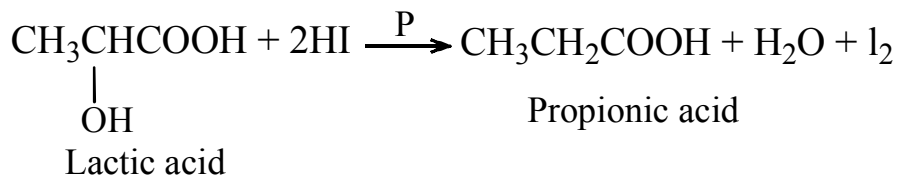

5. **Formation of esters:** On treatment with alcohol hydroxy acid forms esters.

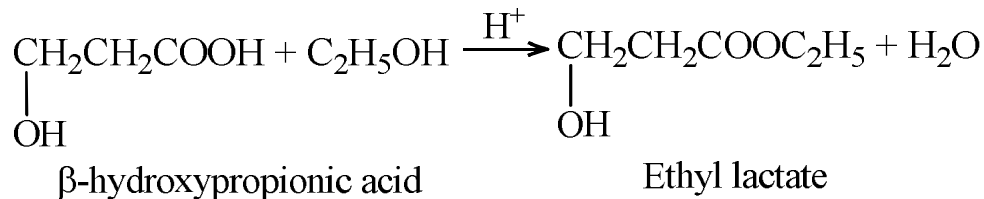

6. **Formation of salts:** Salts are obtained when hydroxy acids are treated with alkali.

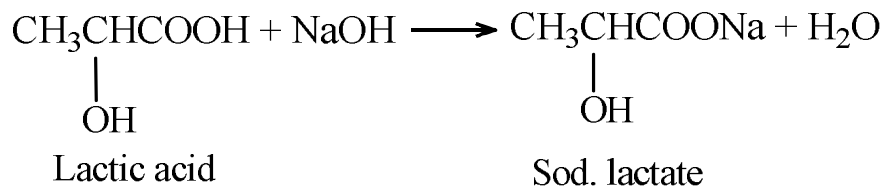

7. **Reaction with sodium metal:** Both of the hydroxy and carboxyl groups are reacted when treated with sodium metal.

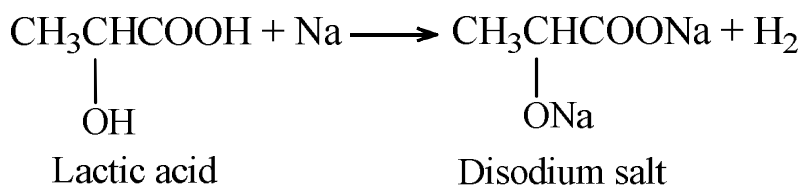

8. **Action of PCl_5 :** Hydroxy acids react with PCl_5 , when both the hydroxy and carboxy groups are chlorinated.

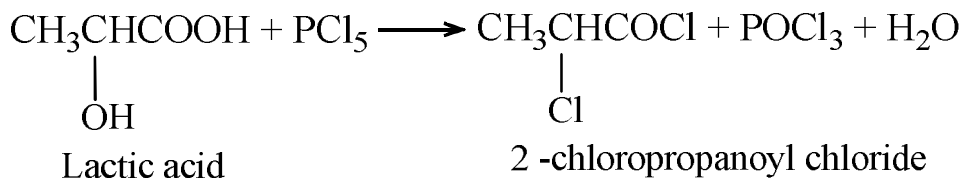

9. **Action of heat:** Hydroxy acids on heating yield different products depending upon the position of the hydroxy group relative to the carboxylic group.

- a. **α -hydroxy acids:** Two molecules of α -hydroxy acid on heating form cyclic diesters known as lactides by the interaction of $-\text{OH}$ from one molecule and COOH from the other molecule

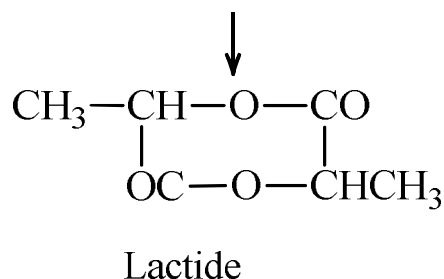
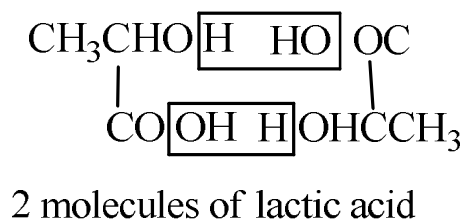
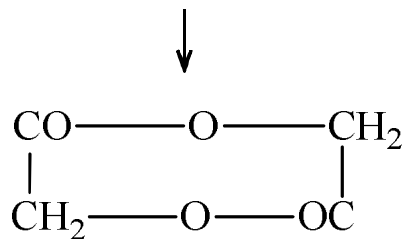
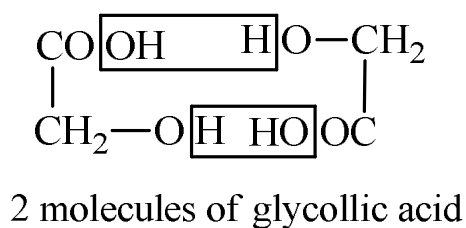

- b. **β -hydroxy acid:** β -hydroxy acids on heating liberate water molecule and give α,β unsaturated carboxylic acid.

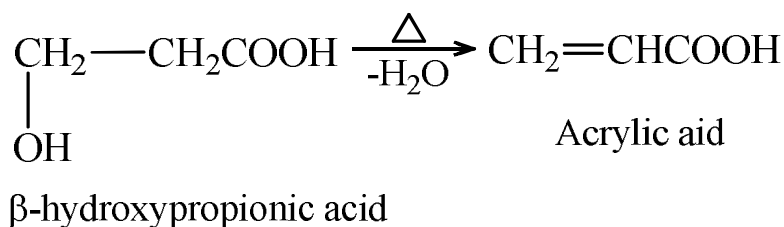
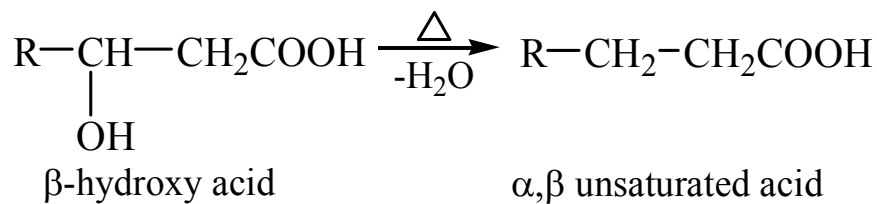

This reaction is catalysed by acids. The mechanism of reaction is as follows:

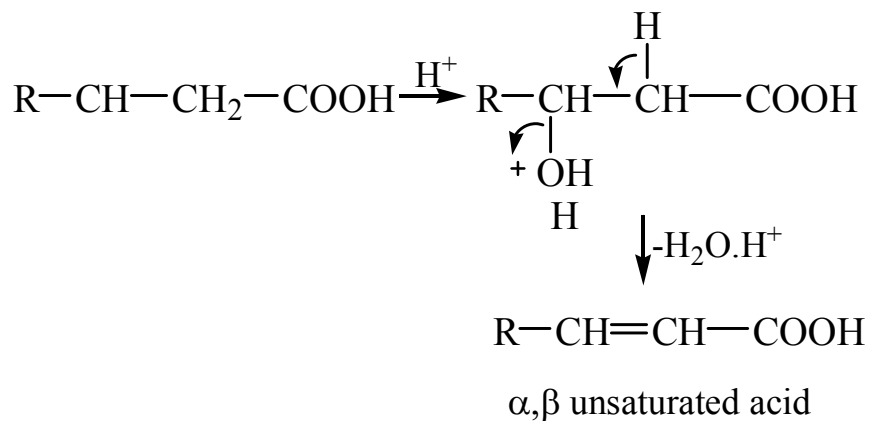

5.14 Salicylic Acid: Methods of preparation

Salicylic acid is prepared by the following methods:

1. **Kolbe's reaction:** carbon dioxide under pressure is passed over sodium phenoxide at 400 K temperature. Sodium salicylate is obtained which on hydrolysis yields salicylic acid.

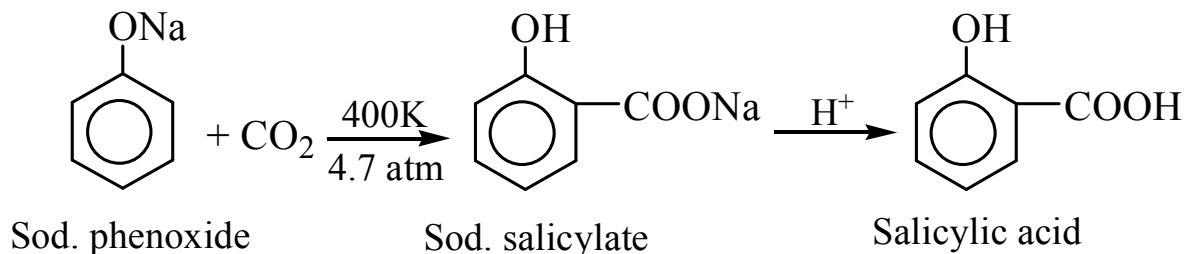

Mechanism: Mechanism of the reaction is as follows:

- a. Carbon dioxide attacks the phenoxide ion by nucleophilic addition mechanism. A proton is removed from the position where CO₂ is attached. Salicylic ion is product.
- b. Hydrolysis leads to the final product viz. Salicylic acid. These steps are illustrated as under:

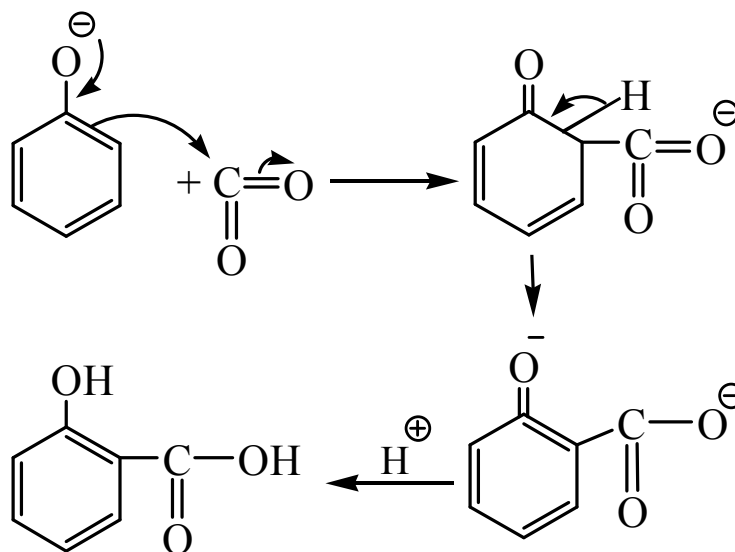

2. **Reimer-Tiemann Reaction:** Sodium phenoxide on heating with carbon tetrachloride in alkaline medium gives sodium salicylate which upon hydrolysis gives salicylic acid.

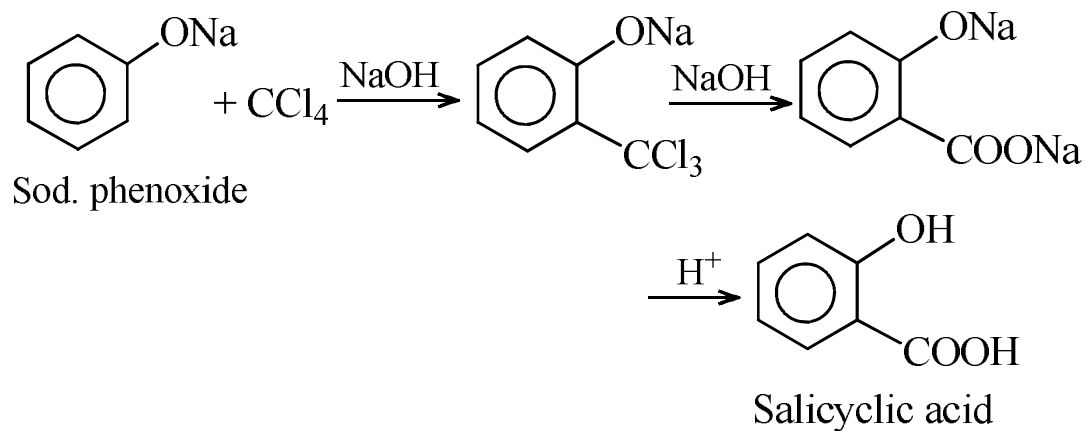

Mechanism: Mechanism of the reaction is given below:

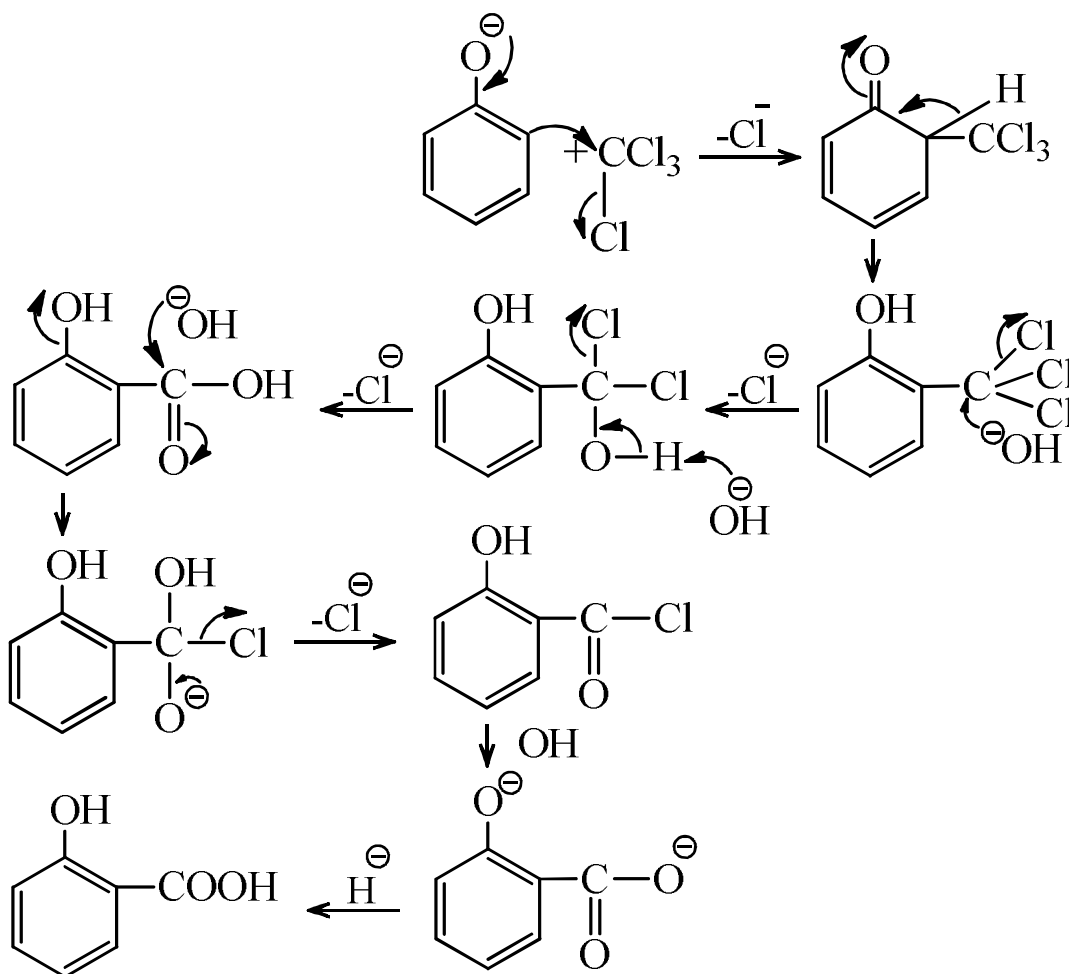

3. Action of nitrous acid on anthranilic acid:

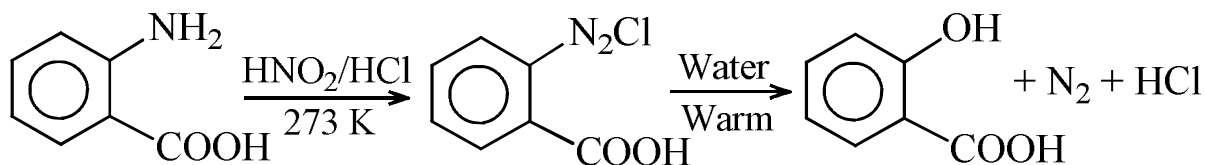

5.15 Properties of salicylic acid

1. **Reaction with alkalis and carbonates:** Alkalis reacts with both the phenolic and carboxylic group whereas carbonates react only with carboxylic group.

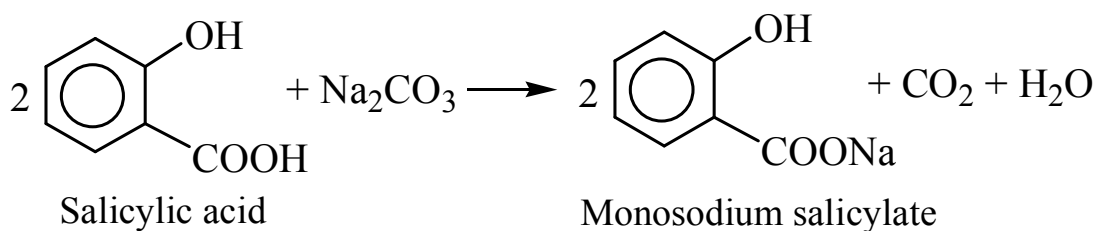
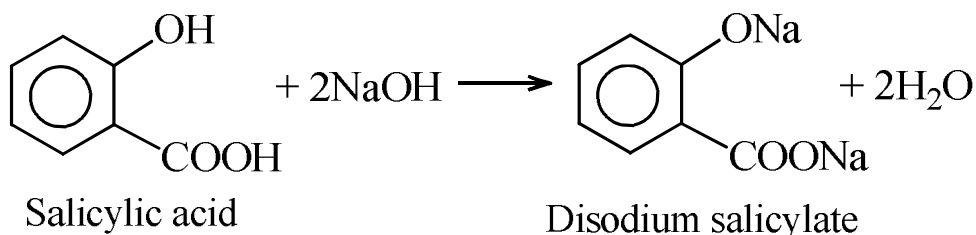

2. **Reaction with alcohols and phenols:** Formation of esters takes place with both alcohols and phenols.

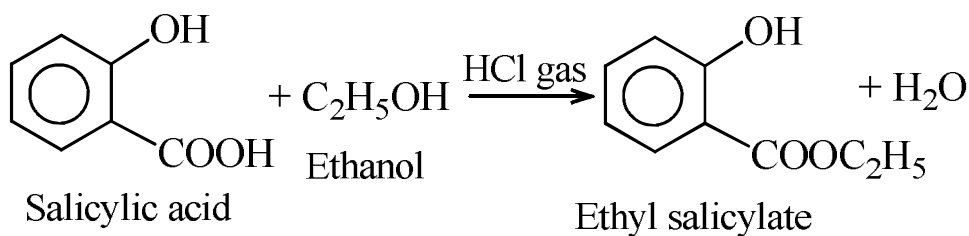

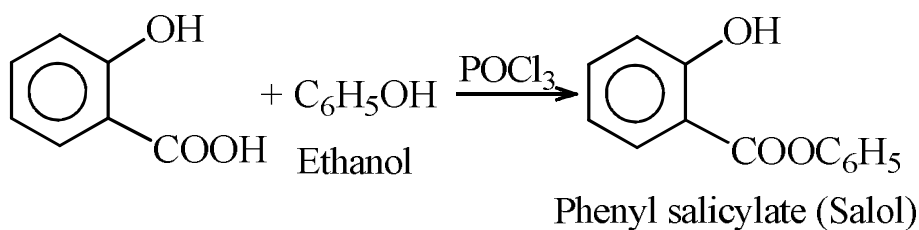

3. Reaction with Phosphorus pentachloride:

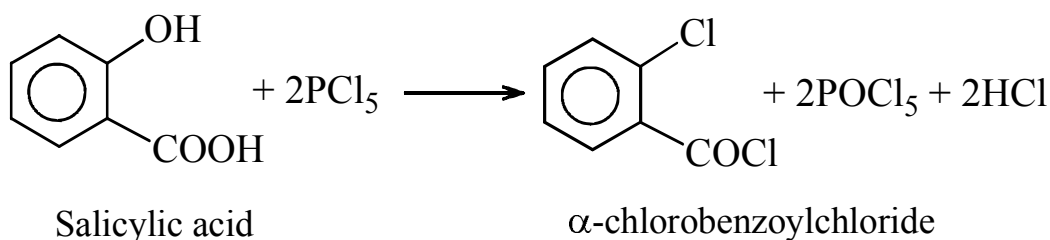

4. Reaction with acetyl chloride and anhydride:

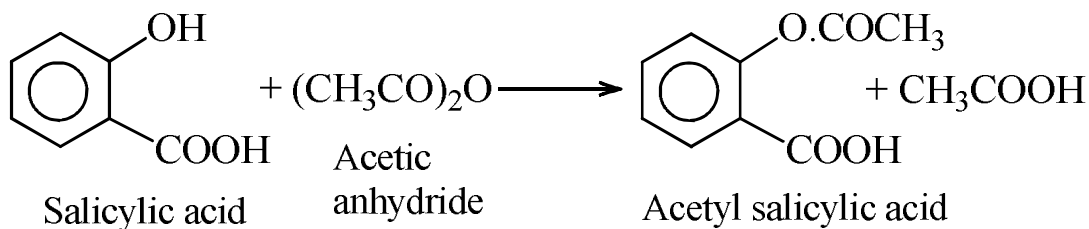
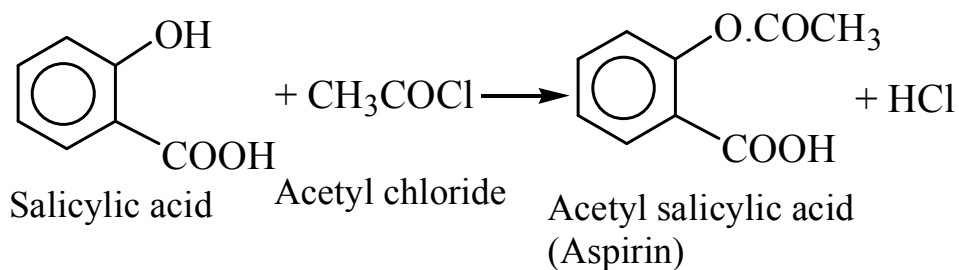

5. Reaction with soda lime: Carboxylic group is eliminated on heating with soda lime leaving the phenolic group.

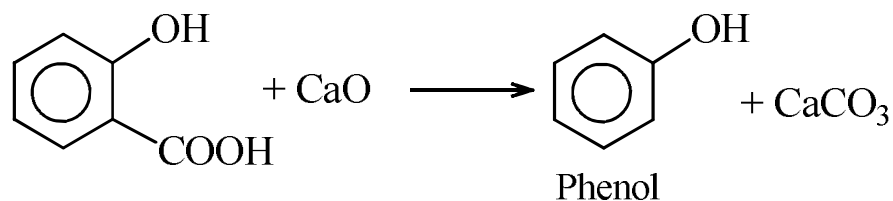

6. **Reaction with Zn dust:** on heating salicylic acid with Zn dust, phenolic group is eliminated leaving behind the carboxy group.

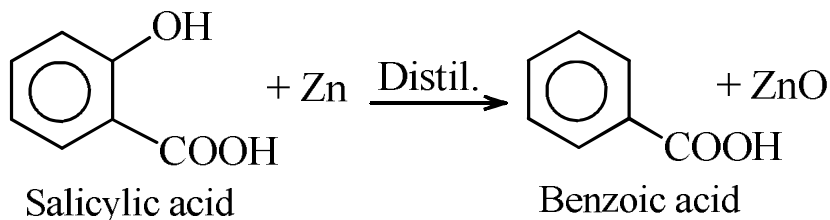

7. **Electrophilic substitution reactions:** Halogenation, nitration and sulphonation can be performed on salicylic acid.

Sulphonation: Sulfonic group takes the para position with respect to phenolic group

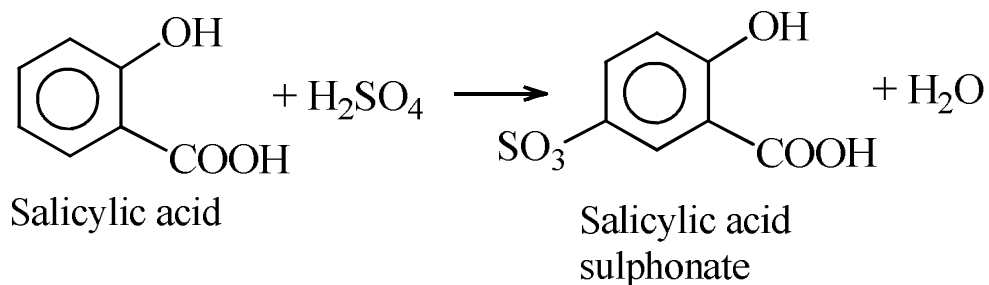

Bromination: During bromination, carboxylic acid decompose and tribromo product is formed

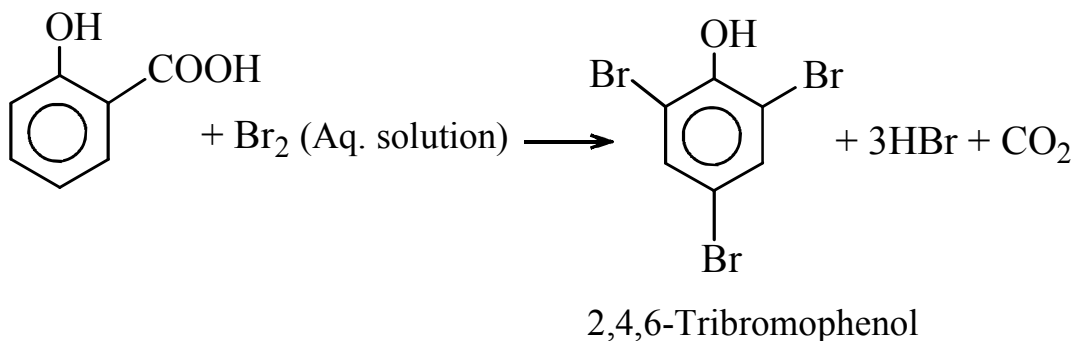

Nitration: As in the case of bromination, Nitration takes place with the simultaneous decomposition of carboxylic group.

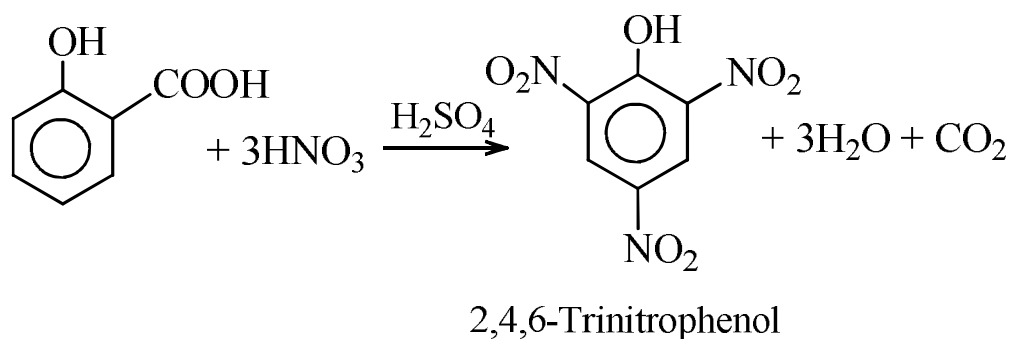

Mechanism of decomposition of carboxylic acid during the course of halogenation and nitration is illustrated below:

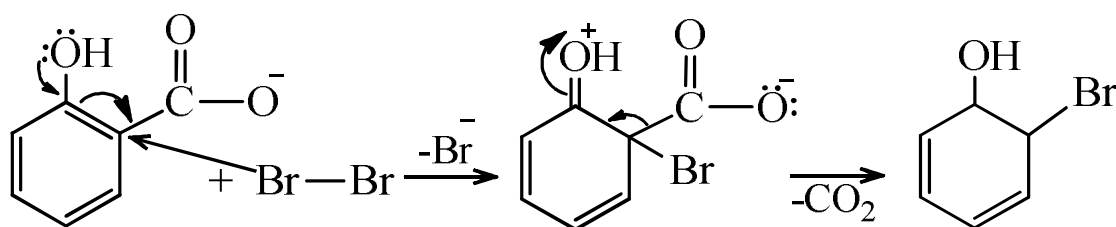

5.16 Unsaturated Monocarboxylic Acids

α,β unsaturated acids are organic Carboxylic acids having a double bond between α and β position i.e. at position next and still next to the carboxylic group.

Nomenclature

Nomenclature of a few important α,β unsaturated acids are given in Table 5.6

Table 5.6. Common and IUPAC names of unsaturated acids.

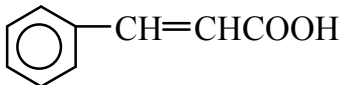
α,β unsaturated acid	Common name	IUPAC name
$\text{CH}_2=\text{CH}-\text{COOH}$	Acrylic acid	Propenoic acid
$\text{H}_3\text{CCH}=\text{CH}-\text{COOH}$		
$\begin{array}{c} \text{CH}_3 \\ \\ \text{CH}_2=\text{C}-\text{COOH} \end{array}$	Crotonic acid	But-2-enoic acid
	Methyl acrylic acid	2-methylpropenoic acid
	Cinnamic acid	3-phenylpropenoic acid

5.17 Methods of preparation of α,β -unsaturated acids

Such as it can be prepared by the following general method:

1. Oxidation of α,β -unsaturated aldehyde:

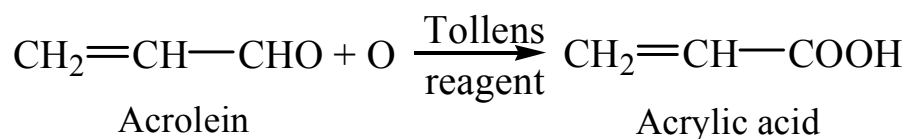

2. Dehydrohalogenation of β haloacids: α,β unsaturated acids can be obtained by the dehydrohalogenation of β -halo acid using alcoholic potassium hydroxide

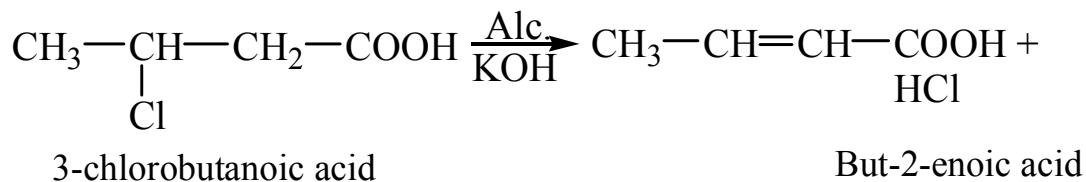

The reaction is supposed to take place by the following mechanism

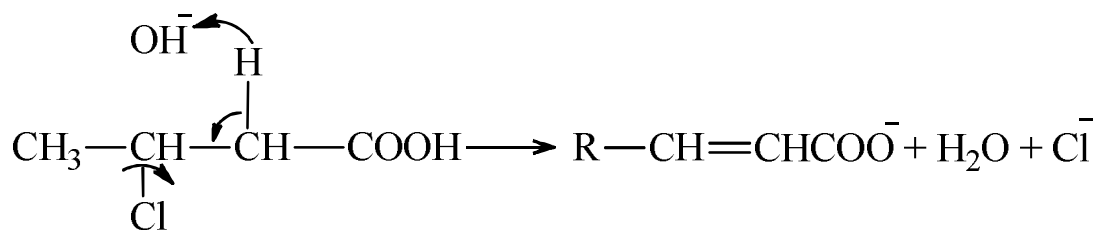

3. **From alkynes:** Acetylene is treated with HCN to give an addition product which is subjected to hydrolysis.

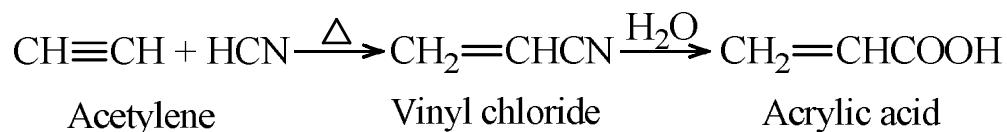

4. **Dehydration of β -hydroxy acid:**

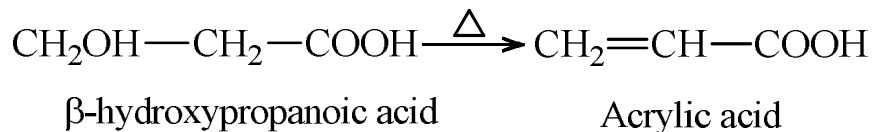
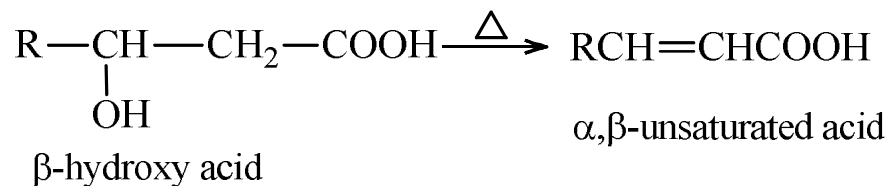

5. **From Grignard reagent:** Vinyl halide is treated with Mg to give vinylmagnesium halide which on treatment of CO_2 in THF gives acrylic acid

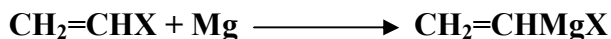

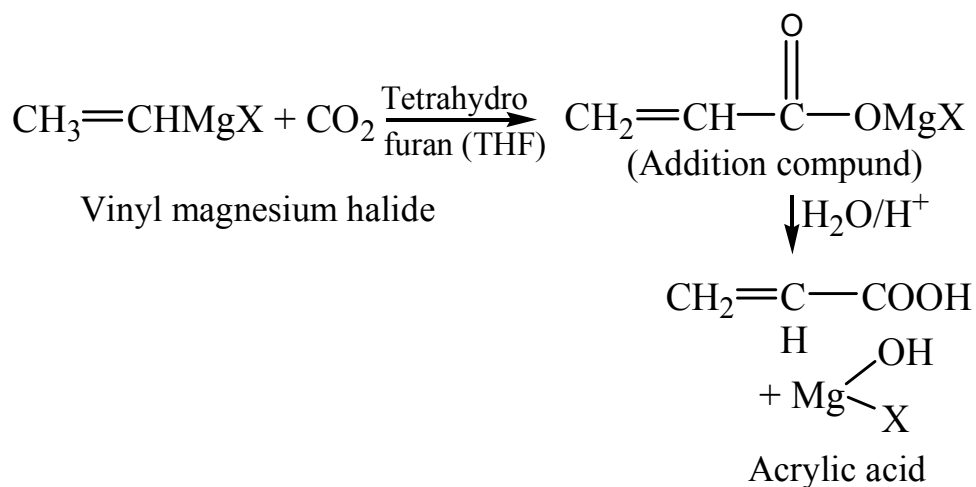

6. **Perkins reaction:**

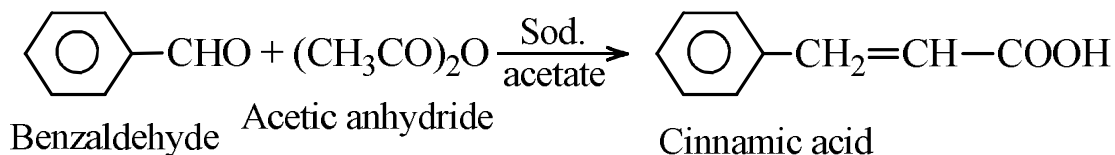

7. **Knoevenagel reaction:**

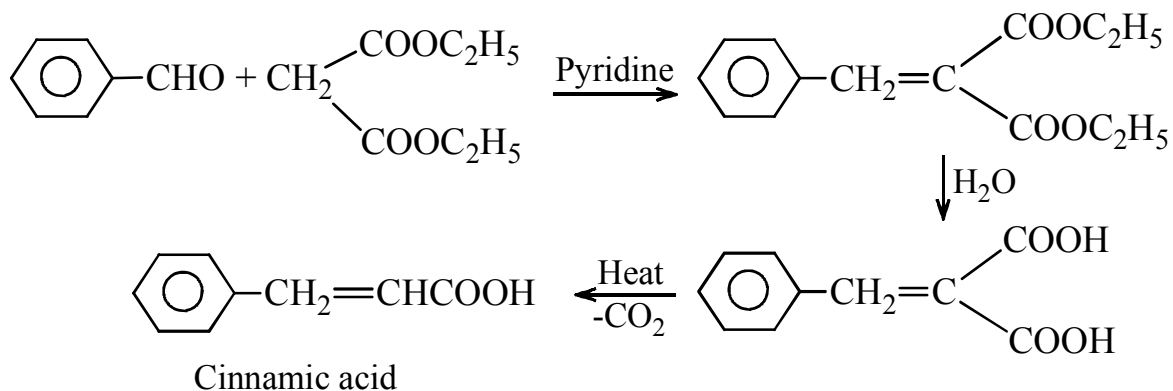

8. **By isomerization:** When unsaturated acids other than α,β -unsaturated acids are boiled with strong alkali, the double bond shifts to the α,β positions on acidification, α,β -unsaturated acid is obtained.

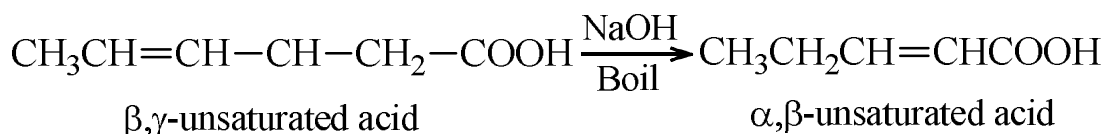

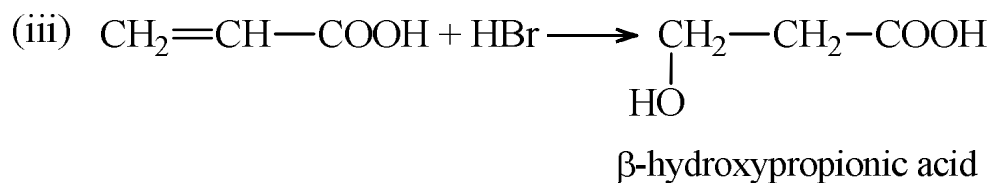

Mechanism of addition:

1. A Proton gets attached to carbonyl oxygen of the carboxyl group giving resonance stabilized positive ion
2. The nucleophile (X^- or OH^-) attacks the carbonium ion at β-position to give enol form of the acid.
3. The enol form tautomerizes to more stable keto form.

These steps are mechanistically shown below:

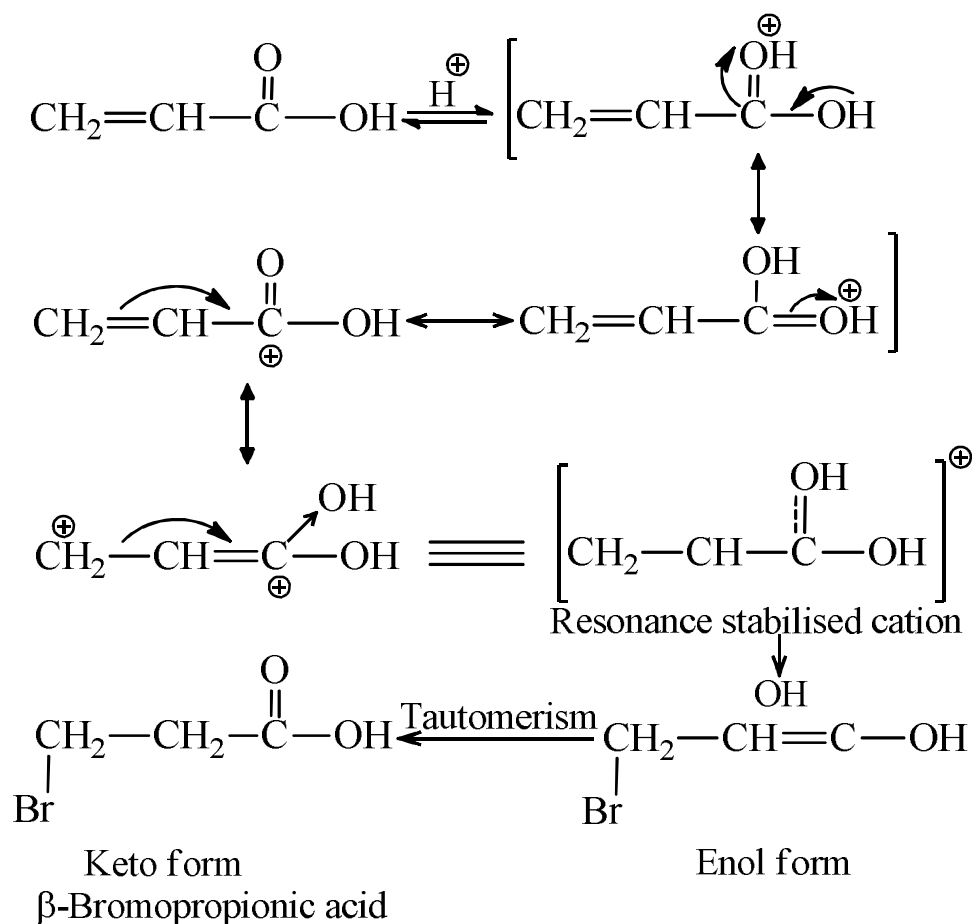

2. Reaction of the Carboxylic group

a. Formation of salt:

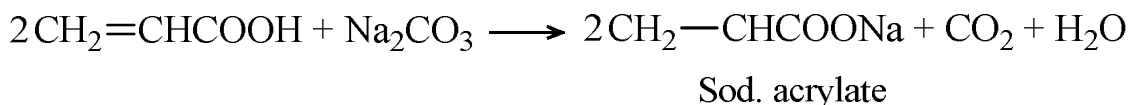
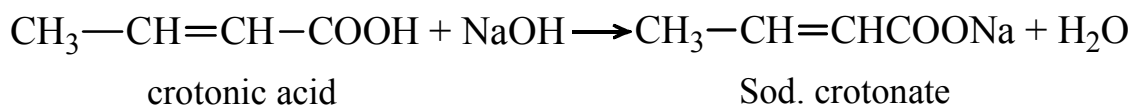

b. Esterification

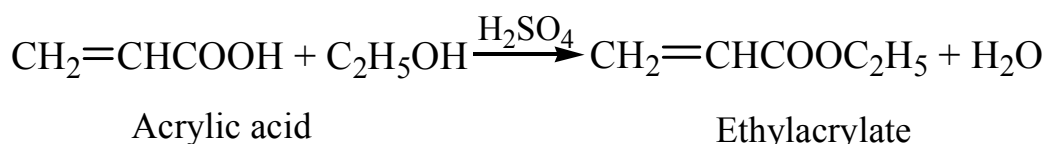

c. Action of PCl_5 :

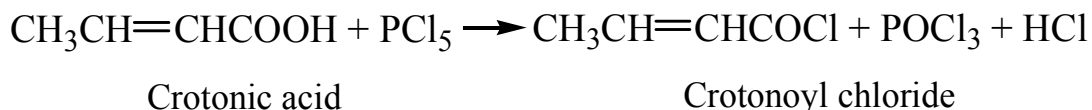

3. **Reduction:** Double bond of the unsaturated acid gets saturated on catalytic hydrogenation or treatment with nascent hydrogen.

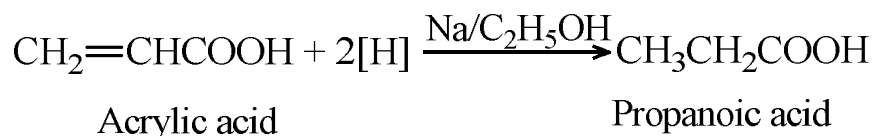

4. **Reaction with alkali:** Unsaturated acid (Alpha Boroether) on fusion with alkali breaks to give acetic acid and one more acid with carbon less.

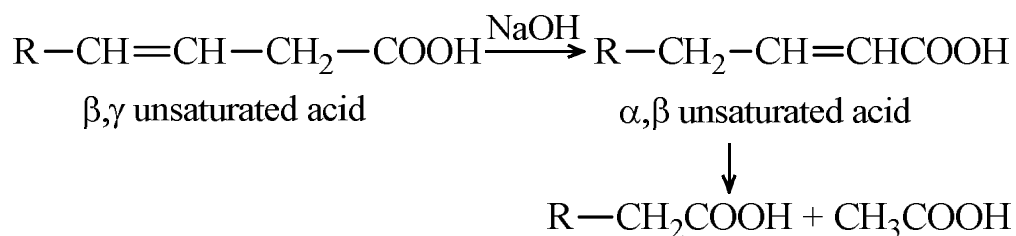

5.19 Dicarboxylic acids

Nomenclature

Dicarboxylic acids are those organic compounds which contain two carboxylic groups in the molecule.

Nomenclature of some prominent dicarboxylic and tricarboxylic acid is given in Table 5.7.

Compound	Common name	IUPAC name
$\begin{array}{c} \text{COOH} \\ \\ \text{COOH} \end{array}$	Oxalic acid	Ethanedioic acid
$\begin{array}{c} \text{COOH} \\ / \\ \text{CH}_2 \\ \backslash \\ \text{COOH} \end{array}$	Malonic acid	Propane-1,3-dioic acid
$\begin{array}{c} \text{CH}_2\text{COOH} \\ \\ \text{CH}_2\text{COOH} \\ \\ \text{CH}_2\text{COOH} \\ \\ \text{CH}(\text{OH})\text{COOH} \end{array}$	Succinic acid	Butane-1,4-dioic acid
	Malic acid	Butan-2-ol-1,4-dioic acid
$\begin{array}{c} \text{CH}(\text{OH})\text{COOH} \\ \\ \text{CH}(\text{OH})\text{COOH} \\ \\ \text{CHCOOH} \\ \\ \text{CHCOOH} \\ \\ \text{CH}_2\text{COOH} \\ \\ \text{CH}(\text{OH})\text{COOH} \\ \\ \text{CH}_2\text{COOH} \end{array}$	Tartaric acid	Butane-2,3-diol-1,4-dioic acid
	Maleic acid	But-2-ene-1,4-dioic acid
	Citric acid	3-hydroxy-3-carboxypentane-1,5-dioic acid

Oxalic Acid

It occurs as potassium hydrogen oxalate in the wood sorrel and tomatoes. The insoluble calcium oxalate is found in some stony deposit in kidneys and bladder in human body.

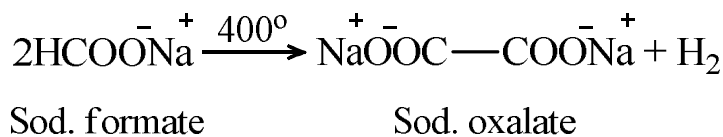

5.20 Preparation of oxalic acid

Oxalic acid is prepared industrially by heating sodium formate to 400° C.

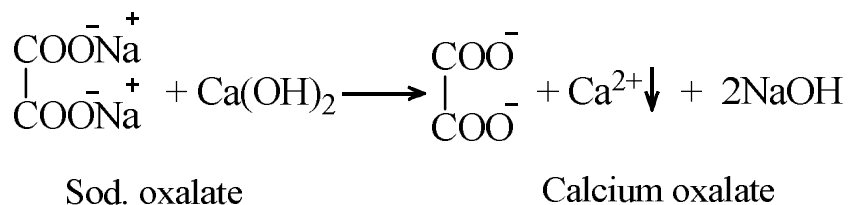

Sodium oxalate thus formed is dissolved in water and calcium hydroxide added to precipitate calcium oxalate. The solution is filtered and the filtrate treated with calculated quantity of dilute sulphuric acid to liberate the oxalic acid, as shown by the following equations.

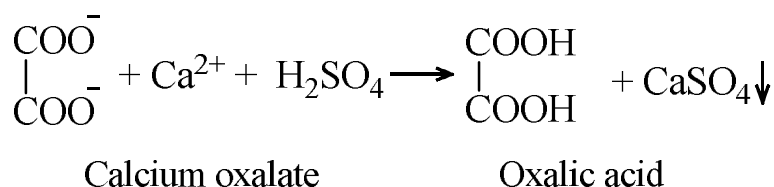

Calcium sulphate is removed by filtration and oxalic acid is crystallized from the filtrate as the hydrate, (COOH)₂·2H₂O.

- Laboratory method:** Oxalic acid is prepared by oxidation of sucrose or molasses with concentrated nitric acid in the presence of vanadium pentoxide as catalyst.

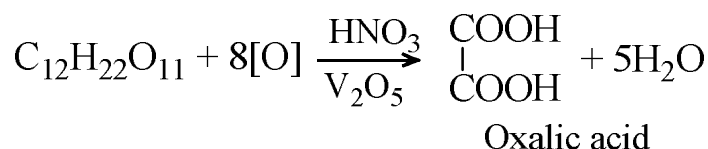

The - CHOH.CHOH- units present in the sucrose molecules are broken and oxidised to oxalic acid.

5.21 Properties of oxalic acid

Physical: when crystallized from water, colorless Prismatic crystals of oxalic acid dihydrate $(\text{COOH})_2 \cdot 2\text{H}_2\text{O}$, are obtained. The hydrated oxalic acid melts at 101.5°C , while the anhydrous acid melts at 189.5°C . The hydrated acid becomes anhydrous when carefully heated to 150°C . Oxalic acid is active poison. It depresses the central nervous system and causes malfunction of kidneys.

Chemical: It gives all the usual reactions of COOH group twice. Also, the acid gives some peculiar reactions which involve the cleavage of the weak linkage between the two highly oxidized carbon atoms.

- Formation of Mono- and Di-derivatives:** Oxalic acid is a much stronger acid than acetic acid and readily forms two series of salts, esters, acid halides and amides by reaction with alkali, alcohol, PCl_5 and ammonia respectively.

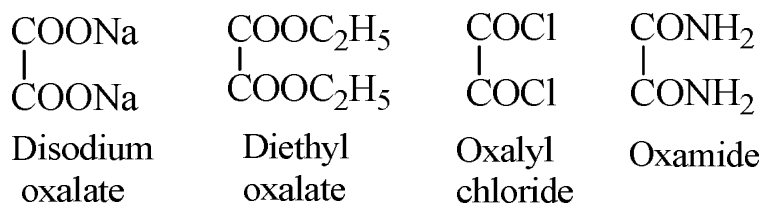

- Action with Glycerol:** Oxalic acid reacts with glycerol to form formic acid or allyl alcohol, depending upon experimental conditions (see under reactions of glycerol)
- Oxidation:** It is readily oxidized, for example with acidified potassium permanganate.

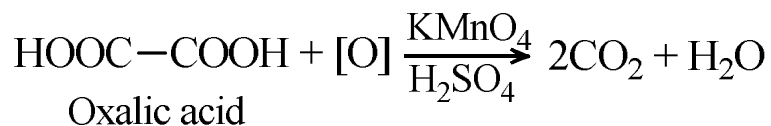

- Action of heat:** When heated at 150°C , it decarboxylates to give formic acid.

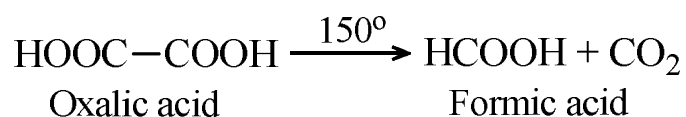

5. **Action with H₂SO₄:** When heated with concentrated sulphuric acid, it decomposes to give carbon dioxide, carbon and water.

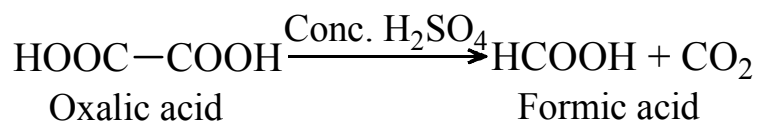

5.22 Uses of oxalic acid:

Oxalic acid is used-

1. For removing ink stains and for bleaching straw.
2. As a mordant in Dyeing and calico painting.
3. In the manufacture of inks and metal polishes.
4. For preparing allyl alcohol and formic acid in the laboratory and
5. In Redox Titrations

5.23 Malonic acid: Methods of preparation of malonic acid

1. By oxidation of malic acid.

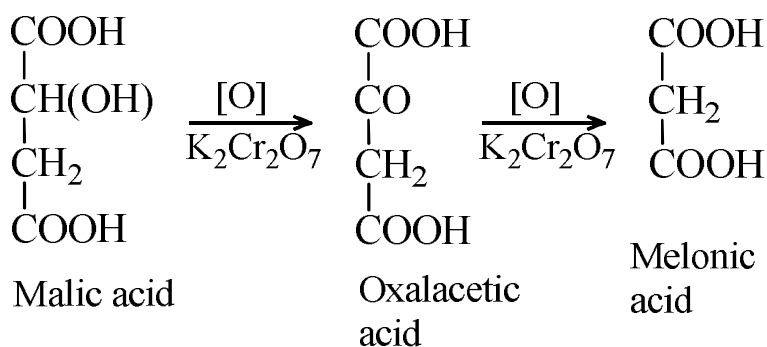

2. From Potassium chloroacetate :

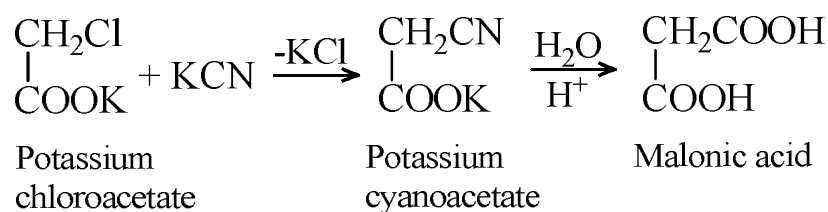

5.24 Properties of malonic acid

1. **Decarboxylation (Action of heat):** on heating to 410-420 K malonic acid decomposes to give acetic acid.

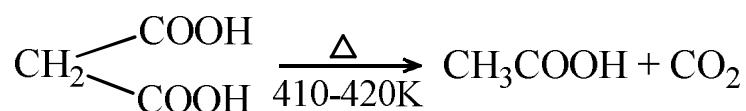

Mechanism of decarboxylation

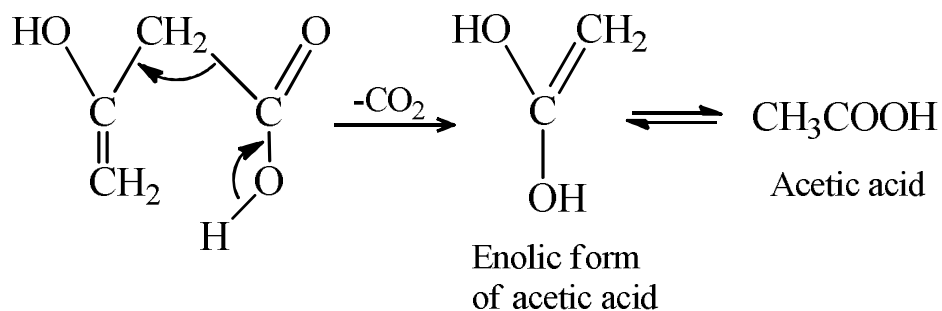

2. **Dehydration:** Malonic Acid loses water molecules on heating in the presence of P_2O_5 .

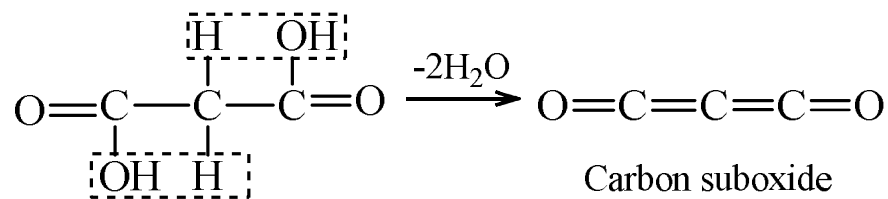

3. **Action of nitrous acid:** On treatment with nitrous acid followed by hydrolysis, malonic acid gives mesoxalic acid.

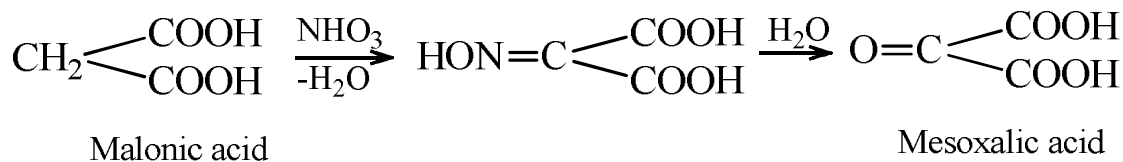

4. Action of bromine

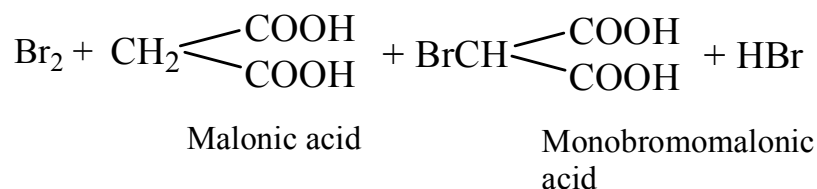

5. Action with aldehyde

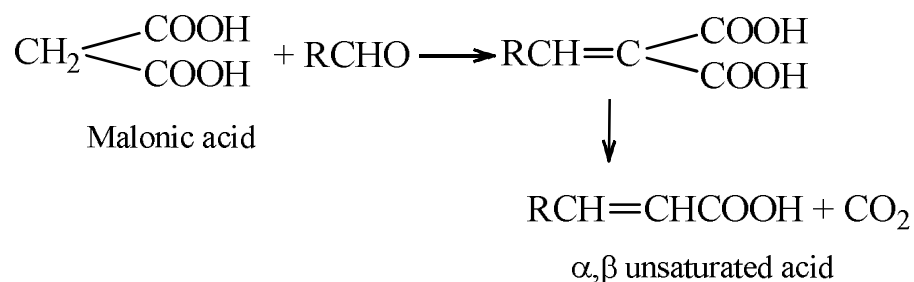

5.25 Maleic acid: Methods of preparation of maleic acid

1. From malic acid (Note the spelling difference between malic and maleic acid)

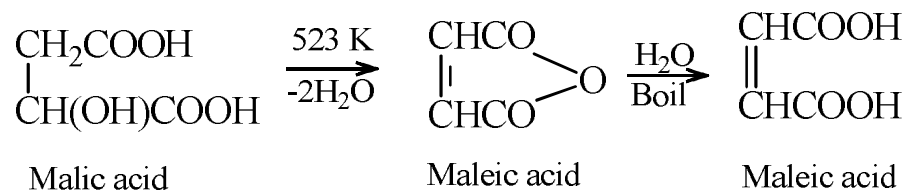

2. From Benzene (Manufacture)

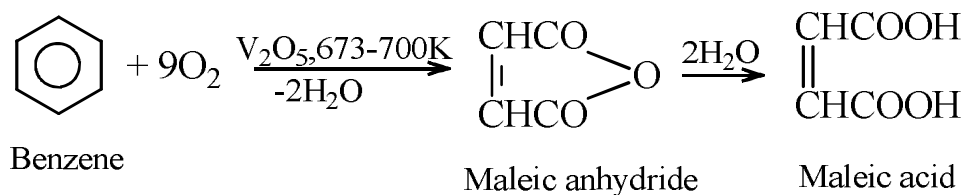

5.26 Properties of Maleic acid

1. **Formation of salts:** It reacts with alkalis to form salts. Two series of salts viz. mono and alkali metal maleats, can be obtained.

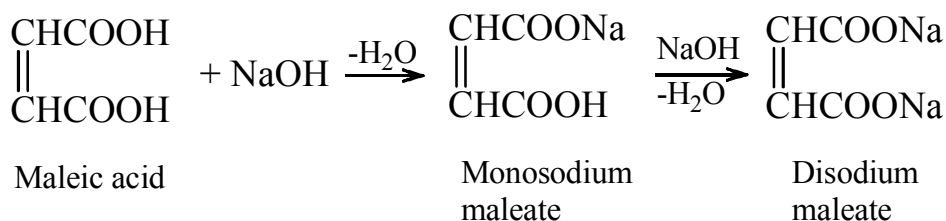

2. **Formation of esters:** Two series of esters viz., Mono and dialkyl maleats, are formed with alcohols.

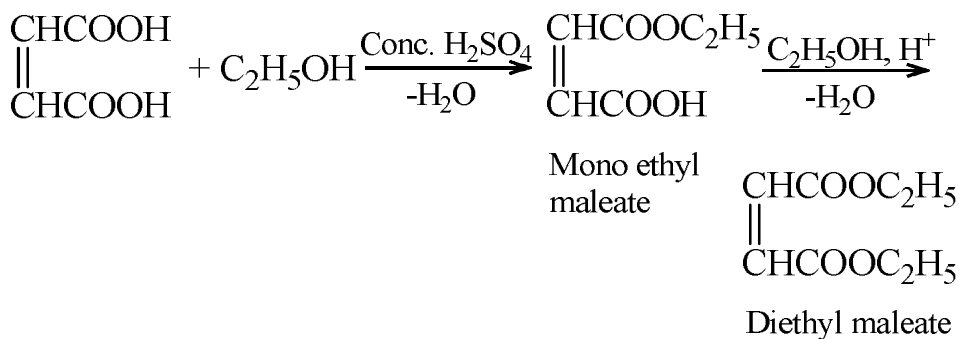

3. **Action of heat:** Maleic acid on heating forms anhydride.

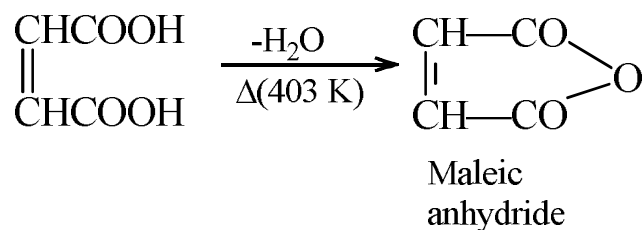

The ease of formation of anhydride suggests that the two carboxylic group are on the same side of the double bond i.e. maleic acid is a cis compound. Two carboxylic group and trans position would make it difficult for dehydration to take place.

4. **Isomerization:** On heating continuously for sufficient time at 423 K or exposure to UV light, it changes into fumaric acid, their Trans isomer which is more stable.

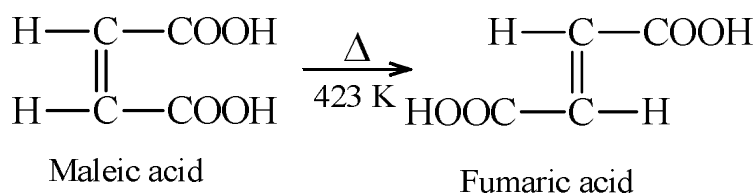

5. **Addition of hydrogen:** On reduction with sodium amalgam and water or catalytic hydrogenation in presence of Ni, maleic acid converts into succinic acid.

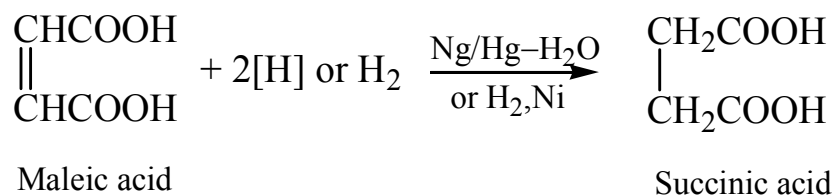

6. **Addition of bromine:**

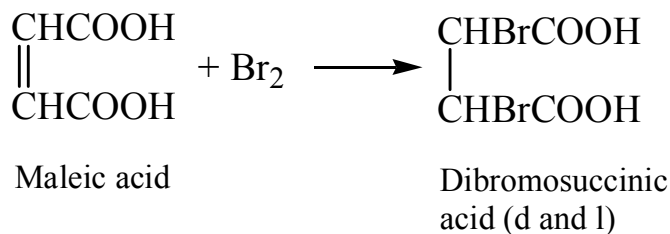

7. Addition of HBr:

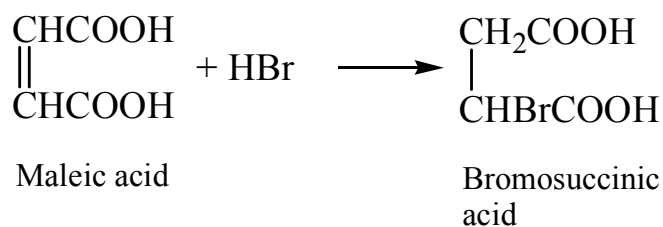

8. **Oxidation:** on oxidation with alkaline potassium permanganate, maleic acid changes into mesotartaric acid.

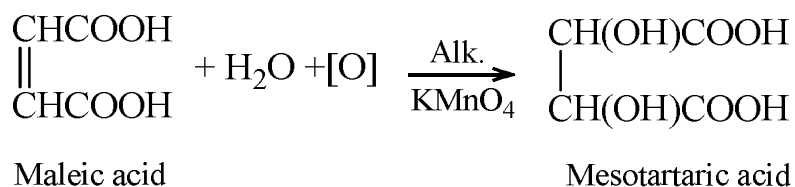

5.27. Fumaric acid: Methods of preparation of fumaric acid

1. **From maleic acid:** On heating for a long time at 423 K maleic acid converts into most stable isomer fumaric acid because of less steric hindrance.

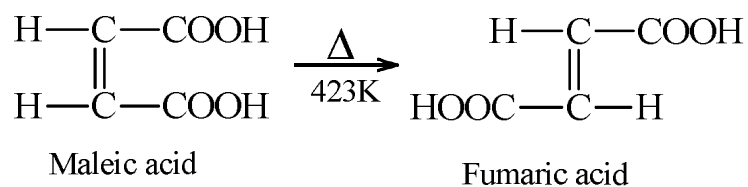

2. **By the action of alcoholic potash on bromosuccinic acid:**

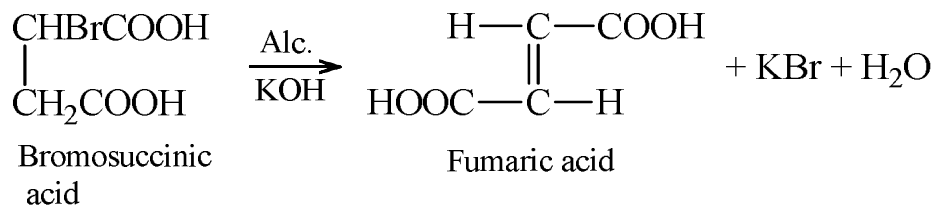

3. From malonic acid:

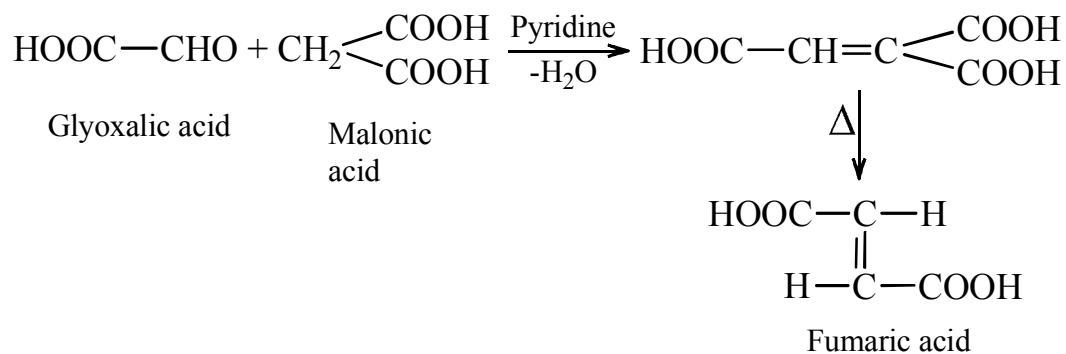

4. **Industrial preparation:** Fermentation of carbohydrate using *Rhizopus nigricans* produces fumaric acid.

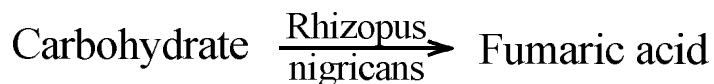

5.28 Properties of Fumaric acid

1. **Dehydration:** Compared to maleic acid, fumaric acid gets dehydrated with greater difficulty at 540 K to give maleic anhydride.

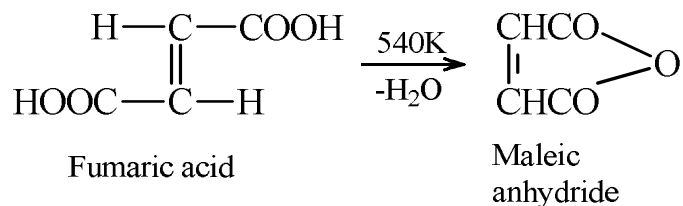

2. Reduction:

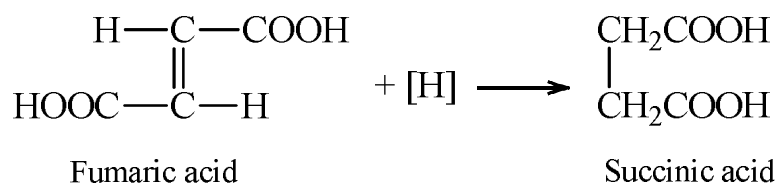

3. Addition of Br₂ of:

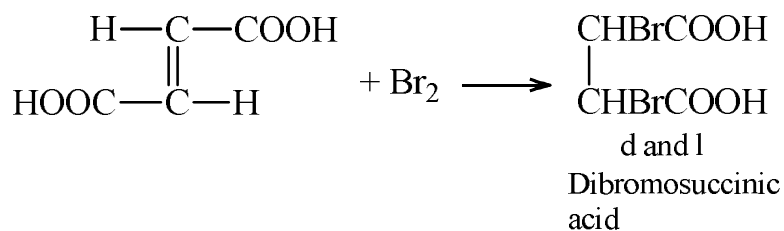

4. Addition of HBr:

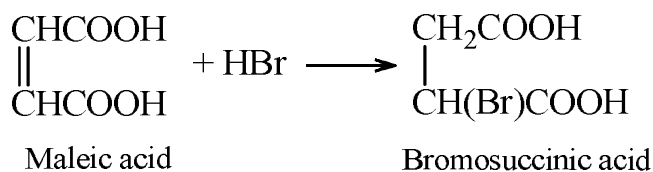

5. Oxidation: When oxidised with alkaline KMnO₄, fumaric acid gives racemic acid gives a racemic mixture of d and l tartaric acids.

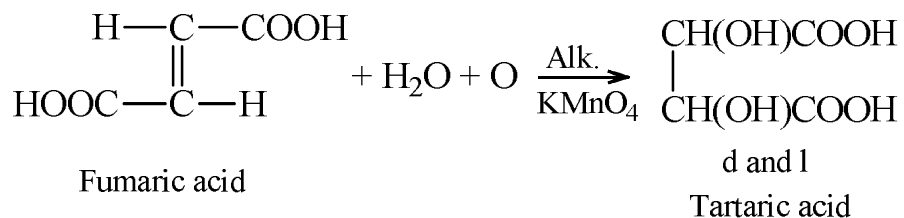

5.29 Malic acid (HOOC-CHOH-CH₂-COOH): Methods of Preparation of Malic Acid

1. It is best prepared from green mountain-ash berries. The extract from the fruit is treated with lime and malic acid gets precipitated as insoluble calcium malate. Calcium malate is filtered off and treated with dilute sulphuric acid to obtain malic acid.
2. By heating maleic acid with dilute sulphuric acid under pressure

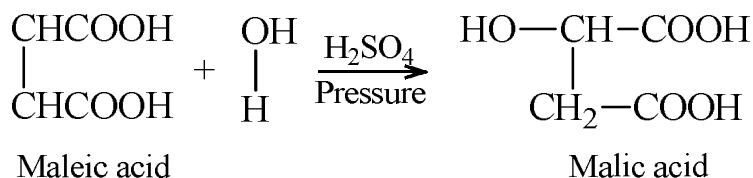

3. By partial reduction of tartaric acid with hydroiodic acid:

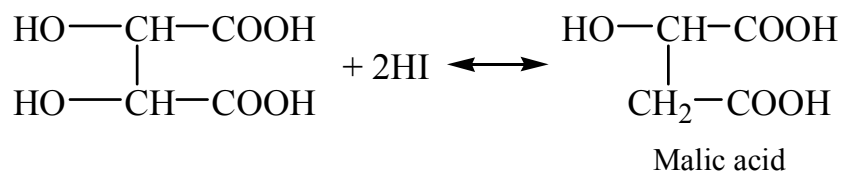

4. Laboratory preparation: By hydrolysis of bromosuccinic acid with moist silver oxide.

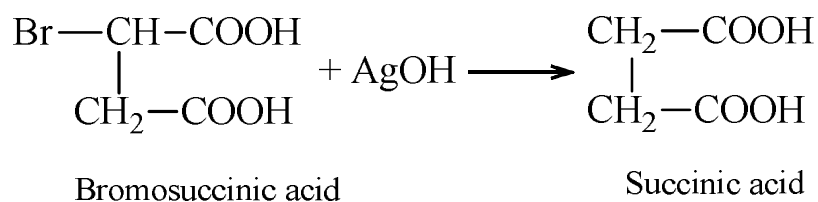

5.30 Properties of Malic Acid

1. **Reduction with HI:** With HI, succinic acid is obtained.

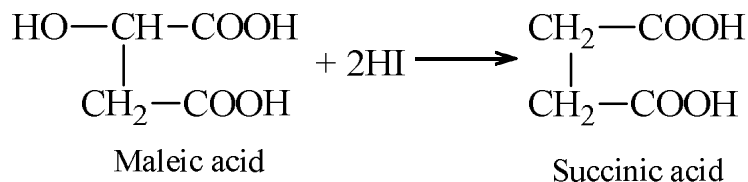

2. **Action of heat:** on heating it forms fumaric acid maleic acid and maleic anhydride.

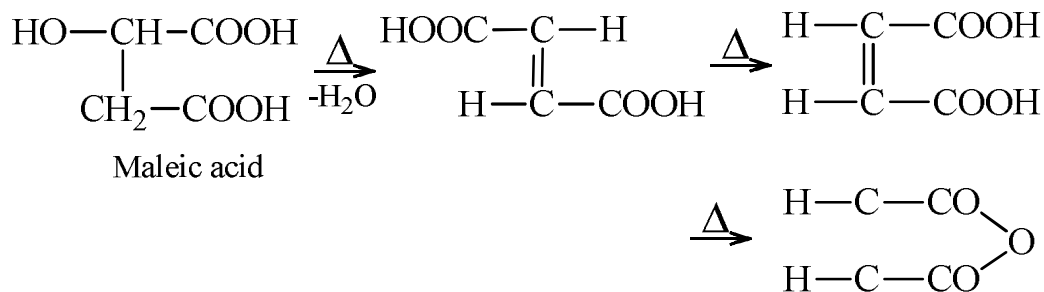

3. **Oxidation:** On oxidation, it is converted into oxal-ascetic with keto-enol tautomerism.

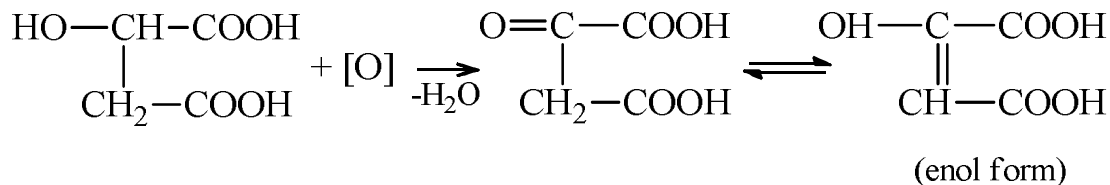

5.31 Tartaric acid: Methods of preparation of tartaric acid

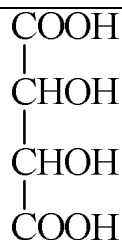

1. **From grape juice:** Tartaric acid occurs as potassium hydrogen tartrate in the grape juice. On fermentation, it separates out as a brown mass known as argol, which is crystallized to

obtain colorless crystals of pure substance, known as cream of tartar this cream of tartar is treated with lime and subsequently with calcium chloride. Calcium tartrate obtained during the process is separated by filtration.

This is neutralized with calculated quantities of sulfuric acid. Calcium sulphate produced during the reaction is removed by filtration. Filtrate is concentrated to obtain crystals of dextro-tartaric acid.

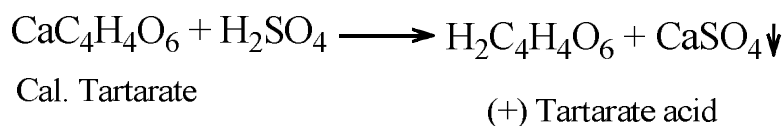
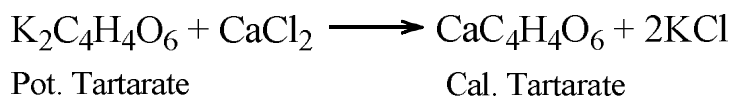
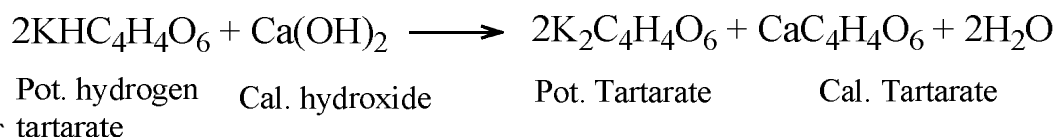

2. **By hydroxylation of maleic and fumaric acids:** Maleic acid and fumaric acids on hydroxylation with alkaline potassium permanganate give meso tartaric acid and racemic tartaric acid respectively.

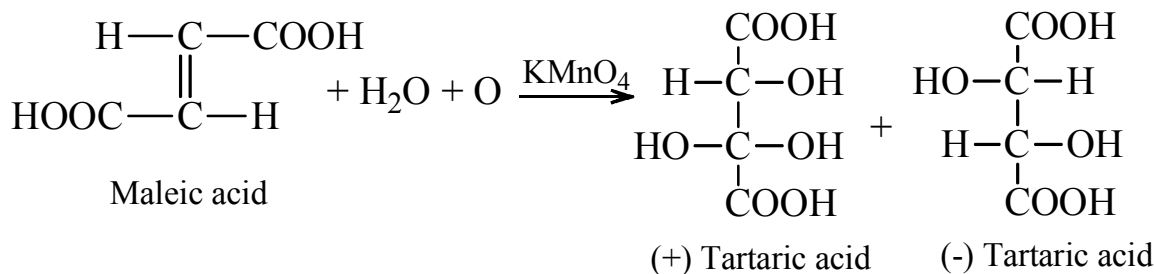
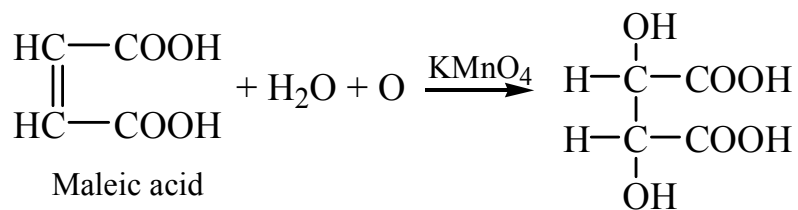

3. Synthesis from acetylene:

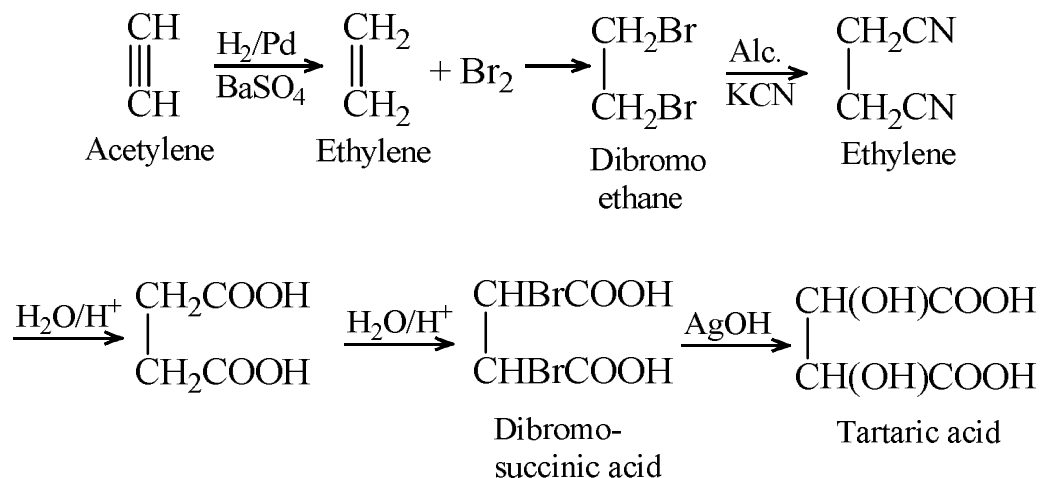

5.32 Properties of Tartaric acid

- Optical isomerism:** Due to the presence of two chiral carbon atoms in the molecule of tartaric acid, it exists in two optically active forms and one optically inactive meso form.
- Formation of salts and esters:** As this compound contains two Carboxylic groups, treatment with alkalies and alcohols gives Salts and esters respectively. Two series of salts and esters are obtained depending upon whether one or two hydrogens of tartaric acid are replaced.

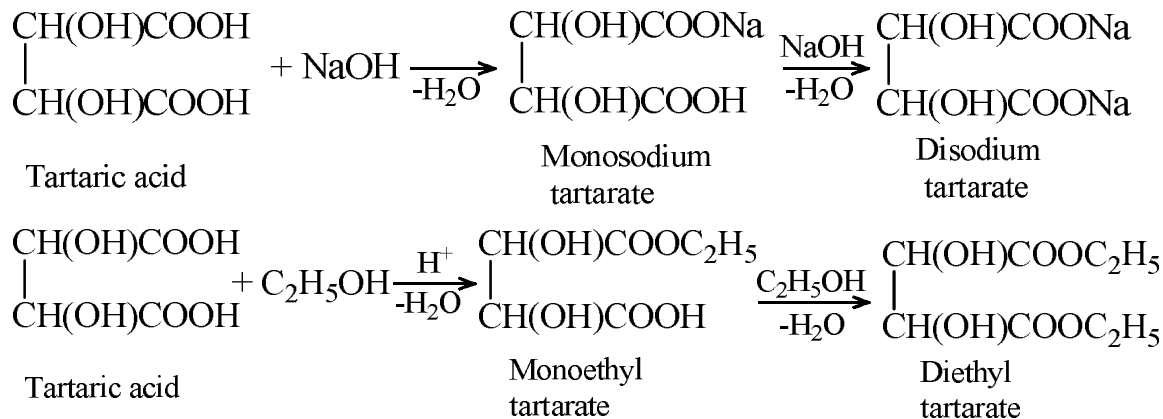

It also forms mixed salt as given below:

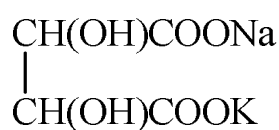

Sod. pot. tartarate
(Rochelle salts)

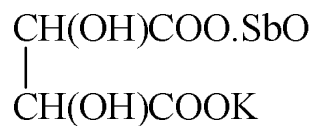

Pot. antimonyl
tartarate
(Tartar emetic)

3. **Dehydrogenation:** On treatment with hydrogen peroxide in the presence of ferrous salts, tartaric acid is dehydrogenated to dihydroxy fumaric acid.

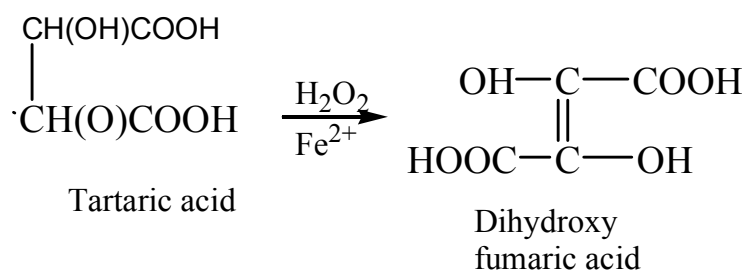

4. **Action of heat:**

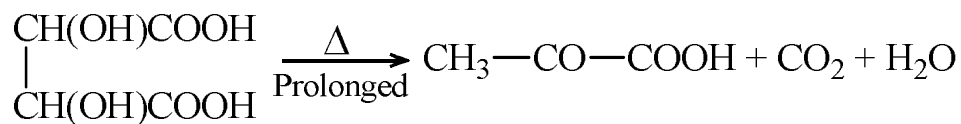

On prolonged heating at 423 K, cyclic anhydride is obtained.

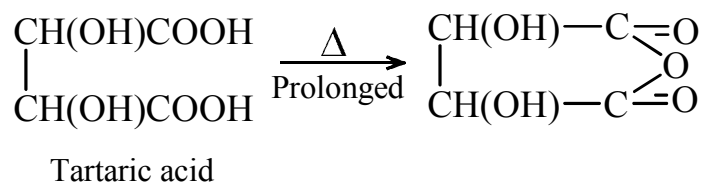

5. **Reduction:** Hydrogen iodide reduces tartaric acid first to malic acid and then to succinic acid.

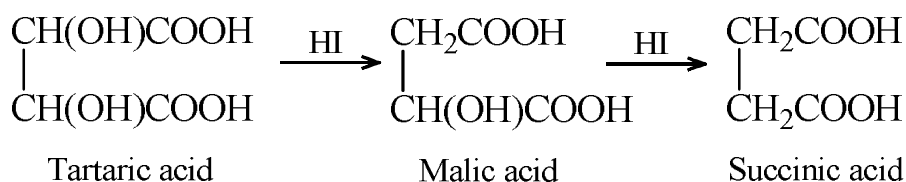

6. Oxidation:

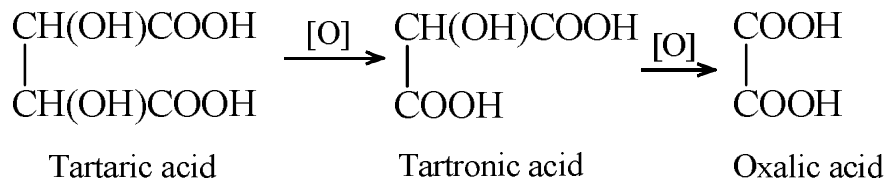

5.33 Citric acid: Methods of preparation of citric acid

- 1. From lemon juice:** Lemon juice is boiled to coagulate proteinous matter which is filtered off. The hot filtrate is neutralized with lime. Citric acid in the filtrate is converted into calcium citrate which is filtered off. Calcium citrate is decomposed to citric acid by treating with a calculated amount of sulfuric acid. Solution containing citric acid is concentrated to crystallize out pure citric acid.
- 2. From molasses:** Fermentation of molasses with microorganism *Aspergillus niger* in the presence of some inorganic salts yields citric acid. The fermentation takes place at a pH value of ?.
- 3. Synthesis of citric acid from glycerol**

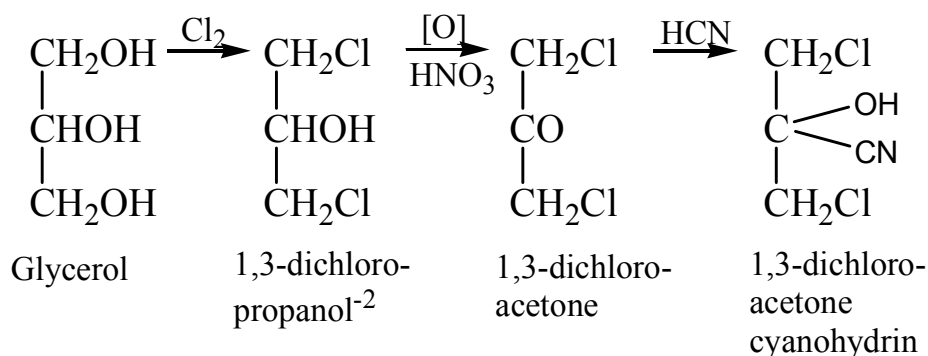

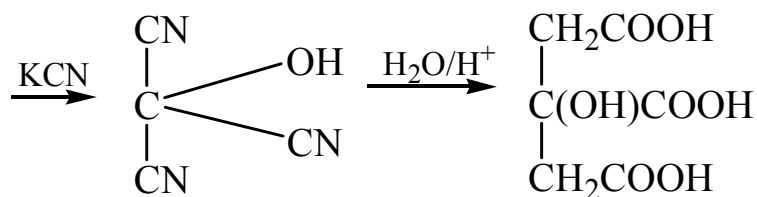

5.34 Properties of citric acid

- Formation of salts and esters:** As it is tricarboxylic compound, there is a possibility to form three series of salts and esters depending upon whether one, two or three carboxy hydrogens are substituted.

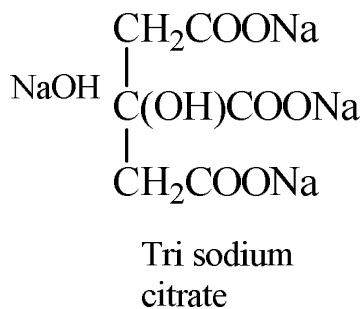
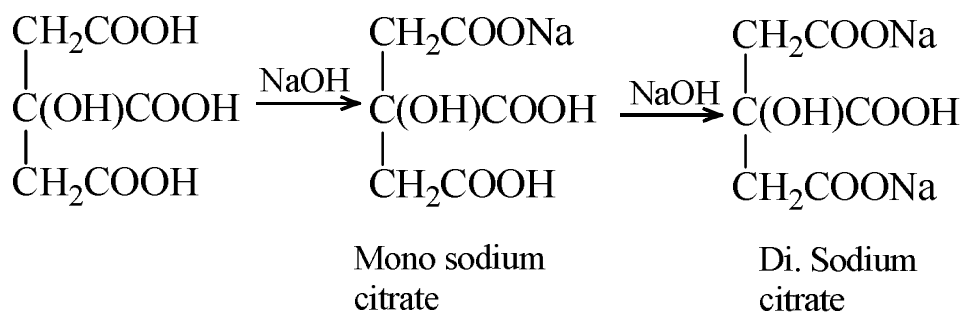

Similarly, formation of Mono, di and tri alkyl citrate takes place on reaction with an alcohol.

- Acetylation:** Acetyl derivatives are obtained with acetic anhydride or acetyl chloride.

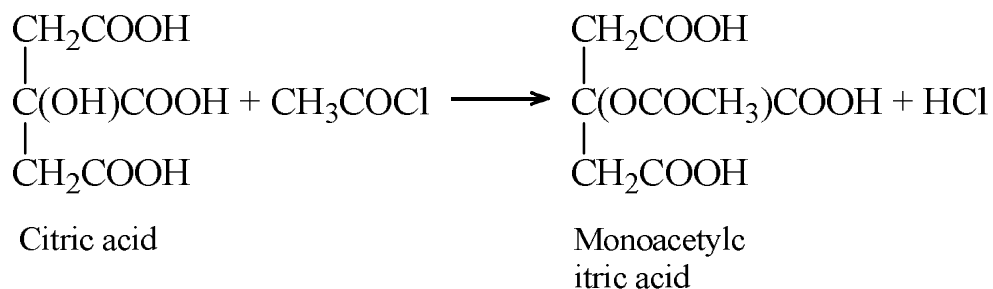

3. Reduction: On reduction with HI, citric acid gives tricarboxylic acid.

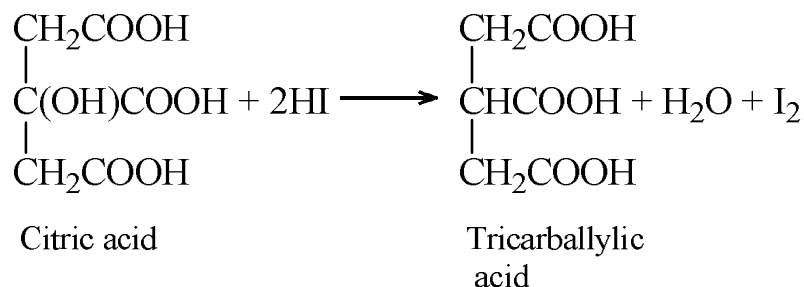

4. Action of fuming sulfuric acid:

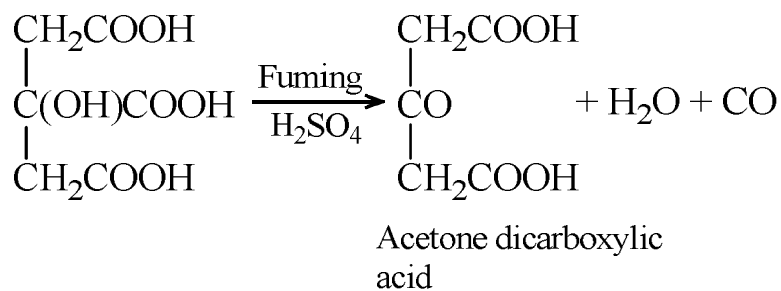

5. Action of heat: When heated to 423 K, citric acid loses a water molecule forming aconitic acid. This reaction is characteristic of β -hydroxy acid.

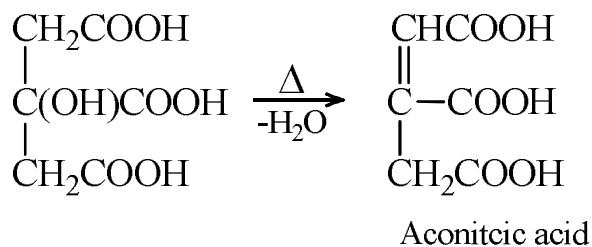

On heating to higher temperatures, aconitic acid further loses a molecule of carbon dioxide to form a mixture of itaconic acid and citraconic acid and mesaconic acid which changed into their anhydrides as shown on page 582.

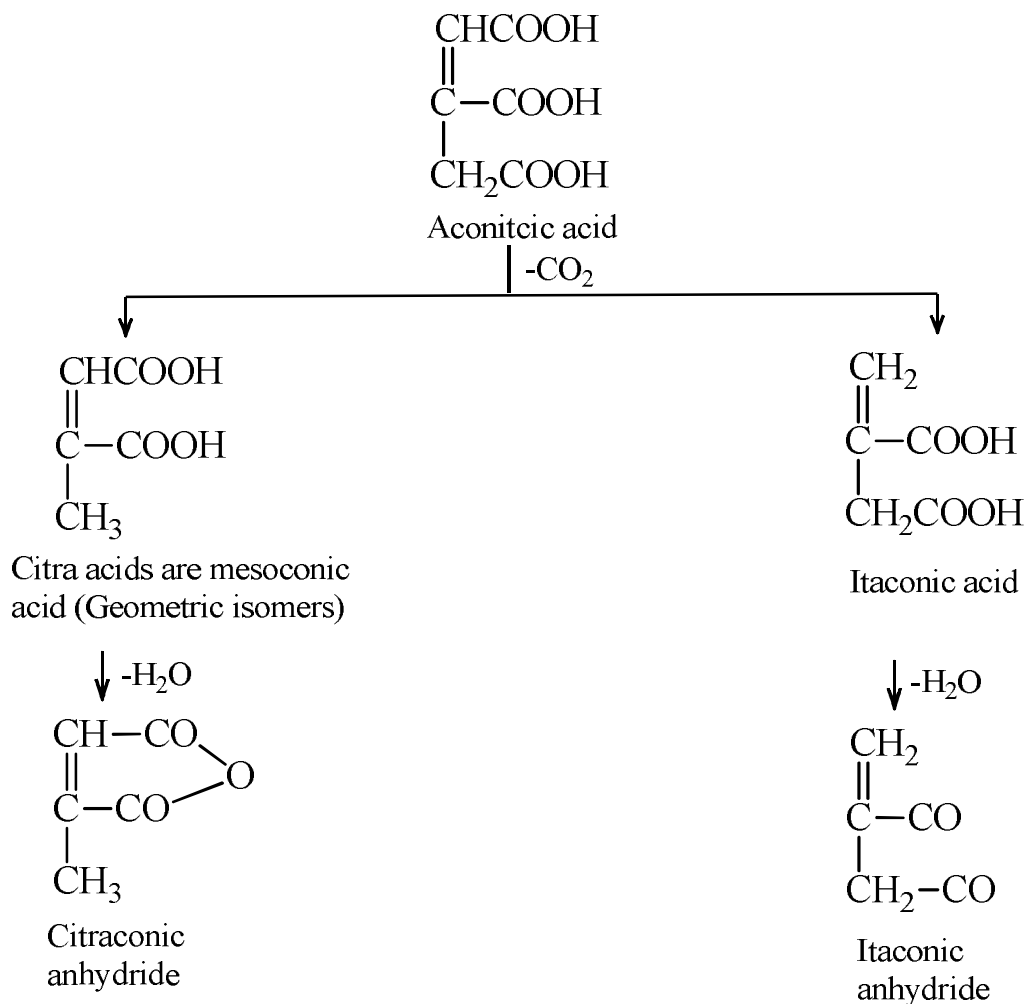

- 6. Complex formation:** Citric acid prevents the precipitation of heavy metal hydroxides by forming soluble complex. This property of citric acid is used in the making of Benedict solution which contains a mixture of copper sulphate, sodium carbonate and sodium citrate.

Short answer question

1. Compare the acidic strength of α -chloro benzoic acid and its p-isomers.
2. Giving reasons, arrange the following in the increasing order of their acidity: 2-chloropropionic acid, 2-fluoropropionic acid and propionic acid.
3. Account for the fact that C–O Bond length is shorter in RCOOH than in ROH.
4. Benzoic acid reacts with sodium bicarbonate to give CO_2 but phenols do not. Justify the statement.
5. Arrange $\text{CH}_3\text{-CHCl-COOH}$, CH_3COOH , and $\text{F-CH}_2\text{-COOH}$ in order of increasing acidity.
6. Arrange the following in order of their acidic strength:
p-Nitrobenzoic acid, o-nitrobenzoic acid and m-nitrobenzoic acid.
7. Giving reasons, arrange the following in order of increasing acidity:

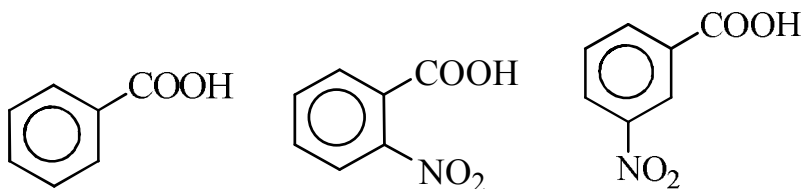

8. $(\text{CH}_3)_3\text{C-COOH}$ does not get esterified in acidic medium. Why?
9. Why does a carboxylic acid do not form an oxime or phenyl hydrazone?
10. Complete the following:



11. Arrange the following in order of increasing acidity giving reasons:
 - a. FCH_2COOH
 - b. CH_3COOH
 - c. ClCH_2COOH
 - d. HCOOH

12. Out of acetic acid and n-propyl alcohol, which is expected to have a higher boiling point and why?

13. How are Carboxylic acids obtained from CO?

14. Complete the following

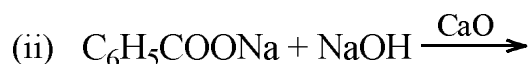

15. Complete the following reactions, giving the names of main products:



16. o-Hydroxybenzoic acid is stronger acid than o-methoxybenzoic acid. Explain.

17. Arrange the following acids in increasing order of their acetic characteristics:



18. Arrange the following acids in descending order of their acidic strength: p- toluic acid, p-bromo benzoic acid, m- bromo benzoic acid, benzoic acid, phenyl acetic acid.

19. Chloro acetic acid is a stronger acid than acetic acid, itself is weaker than formic acid. Justify.

20. Why is benzoic acid weaker than formic acid?

21. Why do alcohols behave as weaker acid than carboxylic acid?

22. p- nitrobenzoic acid is stronger than benzoic acid. Explain.

23. Out of CH_2ClCOOH and CHCl_2COOH , which is stronger and why?

24. Which is the strongest acid in each of the following pairs?

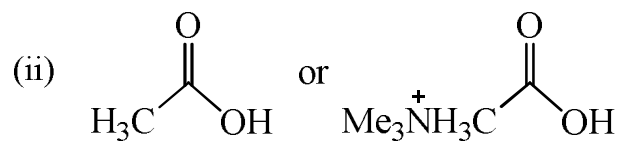
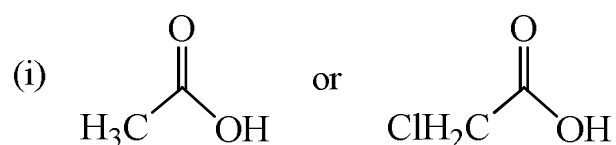

25. Explain why most of carboxylic acid exist cyclic dimers?

26. Discuss the mechanism of esterification of acetic acid with ethyl alcohol.
27. Giving reasons, arrange the following in increasing order of their acidity.
2- chloropropionic acid, 2- fluoropropionic acid and propionic acid.
28. Which is stronger acid and why?
- CH_2ClCOOH and CH_2BrCOOH
 - $\text{CH}_3\text{CH}_2\text{CHClCOOH}$ and $\text{CH}_3\text{CHClCH}_2\text{COOH}$
29. How will you explain that:
- Mono carboxylic acid is stronger than phenol.
 - Fluoroacetic acid is stronger than chloro acetic acid.
30. Complete the following reactions:
- $\text{CH}_3\text{COOH} + \text{CH}_3\text{COCl} \xrightarrow{\text{Py}}$
 - $\text{C}_2\text{H}_5\text{COOH} \xrightarrow[\text{Heat}]{\text{HNO}_3/\text{H}_2\text{SO}_4}$
 - $\text{CH}_3\text{CONH}_2 + \text{Br}_2 + 4\text{KOH} \xrightarrow{\text{Py}}$

31. Give the mechanism of esterification.
32. Write a short note on acidity of carboxylic acid.
33. Give the mechanism of decarboxylation.
34. Write briefly about the following:
- Hell-Volhard-Zelinsky Reaction.
 - p-nitrobenzoic acid is stronger than benzoic acid.
35. Sketch the mechanism of the following reaction.

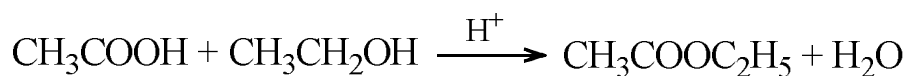

5.4 Carboxylic acid Derivatives

General

A carboxylic acid derivative is compound which is derived obtained from carboxylic acid by performing a reaction.

There are four different types of derivatives which we commonly come across. These are car

- Ester

2. Acid Anhydrides
3. Acid Chlorides
4. Acid Amides

These four types of acid derivatives are obtained replacing the $-OH$ group of the carboxylic acid by $-OR$; $-OCOR$ $-Cl$ and $-NH_2$ groups, respectively.

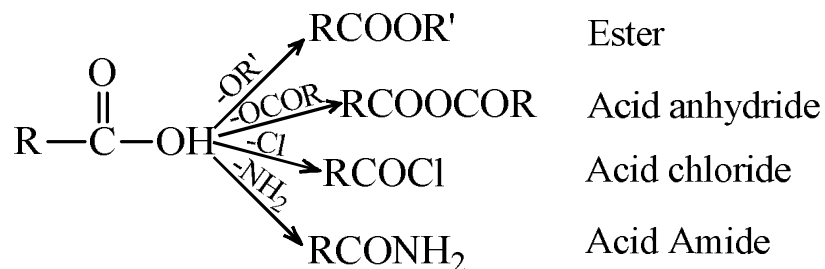

5.41 Nomenclature of Esters

Esters are named as follows by two different system of nomenclature:

1. **Common system:** As an ester is obtained by the combination of a carboxylic acid and alcohol (or phenol) it is named accordingly. The alkyl part of the alcohol is written first followed by the acid part (with the ending -ate).
2. **IUPAC system:** Naming an ester according to this system is not much different from the common system, except that the IUPAC name of the relevant carboxylic acid is used. Name of a few compounds according to both systems of nomenclature are given in Table 6.1

Compound	Common Name	IUPAC Name
$\text{CH}_3\text{COOC}_2\text{H}_5$	Ethyl acetate	Ethyl ethanoate
HCOOC_2H_5	Ethyl formate	Ethyl methanoate
$\text{CH}_3\text{COOC}_6\text{H}_5$	Phenyl acetate	Phenyl ethanoate
$\text{C}_6\text{H}_5\text{COOC}_6\text{H}_5$	Phenyl benzoate	Phenyl benzoate
$\text{C}_6\text{H}_5\text{COOCH}_3$	Methyl benzoate	Phenyl ethanoate

5.42 Methods of preparation of Ester

Esters can be prepared by the following general method:

1. By the combination of carboxylic acid and alcohol (or phenol):

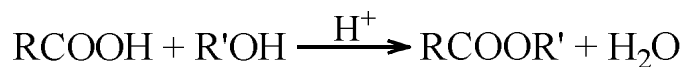

Carboxylic acid Alcohol

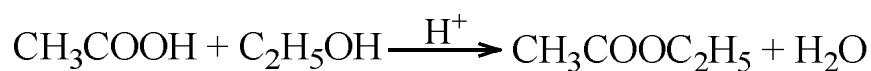

Ethyl ethanoate

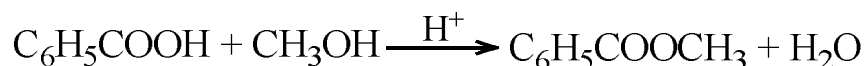

Benzoic acid

Methyl ethanoate

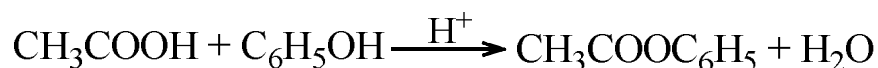

Phenol

Phenyl acetate

This reaction is known as esterification. Its mechanism is described in the chapter on carboxylic.

2. By the combination of acid chlorides or anhydrides with alcohols or phenols:

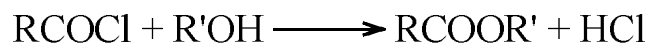

Acid Chloride Alcohol or phenol Ester

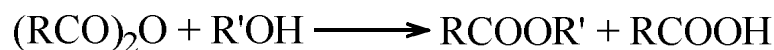

Acid Alcohol or phenol Ester Acid



Ethanoyl chloride

Ethanoyl

Ethyl ethanoate

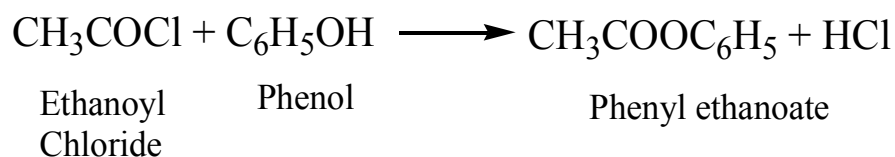
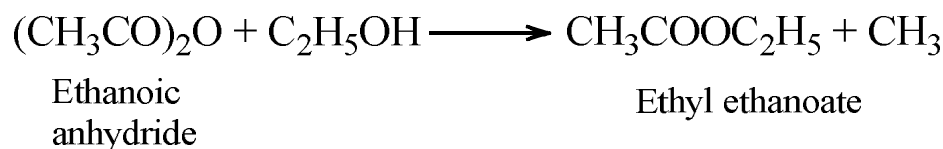

Unlike esterification involving a carboxylic acid and an alcohol, all these reactions do not involve equilibrium between reactants and products. Hence we can expect better yields in such reactions

3. **Trans-esterification:** Treatment of an Ester with an alcohol is different from the constituent alcohol part of the Ester results in the displacement reaction where the two alcohols are interchanged.

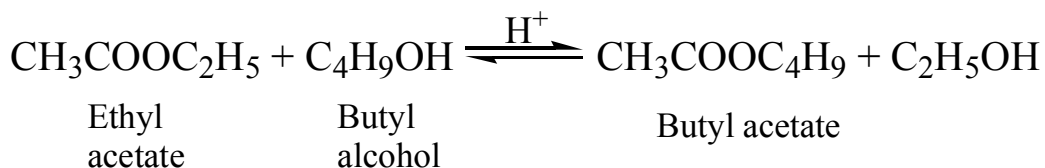

4. **By heating silver salt of an acid with an alkyl halide:**

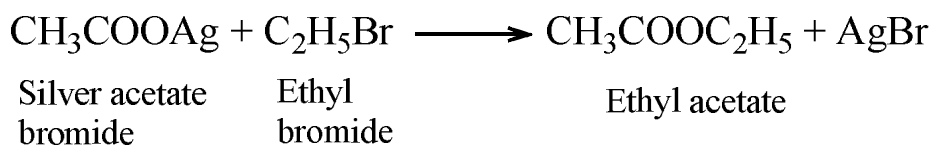
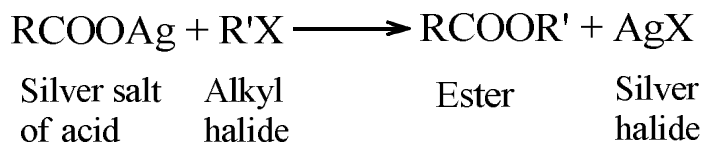

5. **Reaction of carboxylic acid with diazomethane**

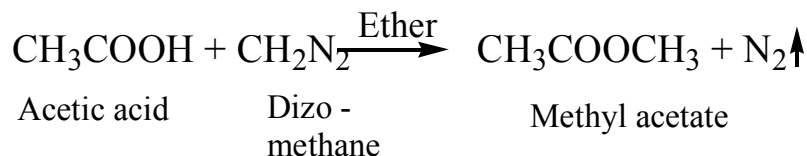

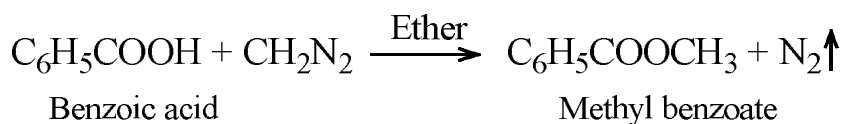

5.43 Physical properties of esters

1. Sweet smell and fragrance in fruits and flowers is due to the presence of ester. Esters present in various substances are as follows:

Fruit	Ester
Orange	Octyl acetate
Banana	Isoamyl acetate
Apple	Isoamyl valerate
Pineapple	Methyl butyrate
Apricot	Amyl butyrate

2. Esters are insoluble in water and show lower boiling points than the corresponding acids. This is due to the absence of hydrogen bonding in esters.

5.44 Chemical properties of esters

1. **Nucleophilic substitution:** Esters undergo nucleophilic substitution that is typical of carboxylic acid derivatives. attack occurs at electron deficient acyl ka and results in the replacement of $-\text{OR}'$ group by $-\text{OH}$, $-\text{OR}''$ or $-\text{NH}_2$.

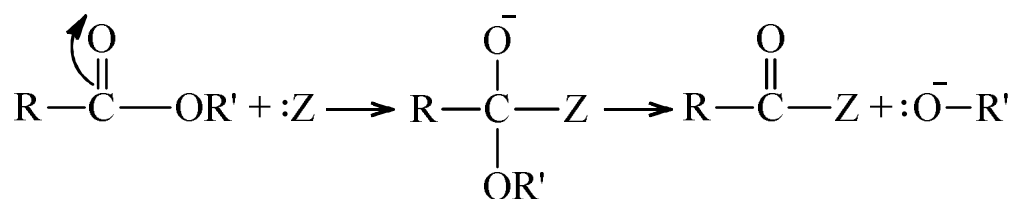

The following reactions are examples of nucleophilic substitution:

Hydrolysis: Esters on hydrolysis in the presence of an alkali give the alcohol (or phenol) and the sodium salt of the carboxylic acid.

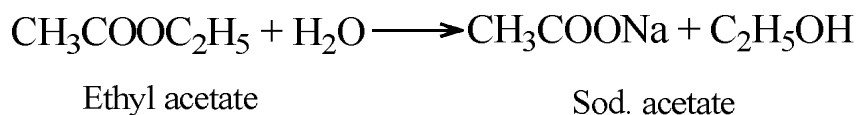
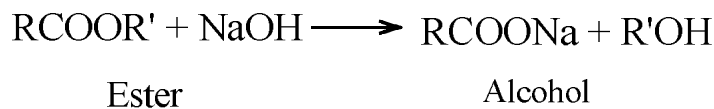

In the presence of an inorganic acid, the hydrolysis takes place as follows:

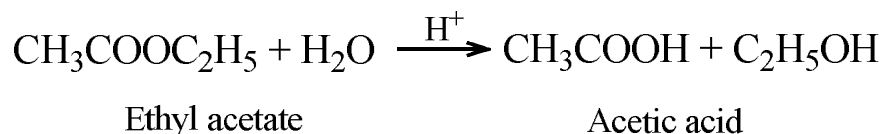

The mechanism of hydrolysis of an ester in the presence of an acid and alkali is explained in the chapter on carboxylic acids.

Action of PCl_5 or SOCl_2 : Esters, on treatment with Phosphorus pentachloride or thionyl chloride, are converted into acid chloride.

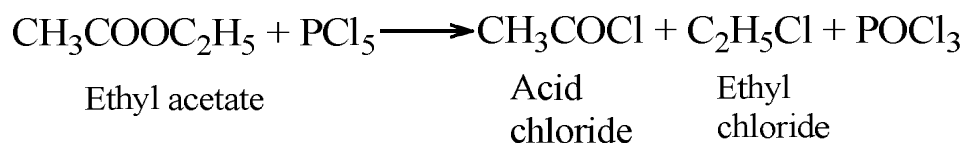
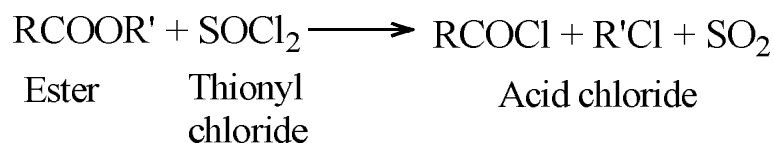
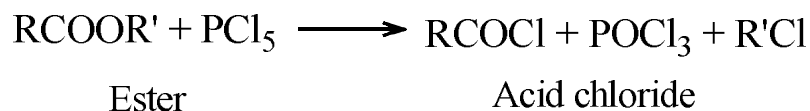

Action of ammonia:

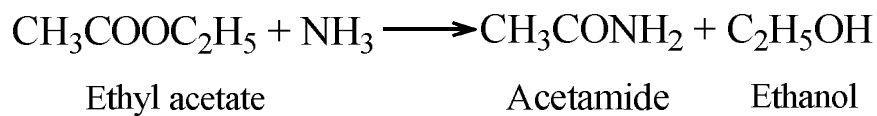
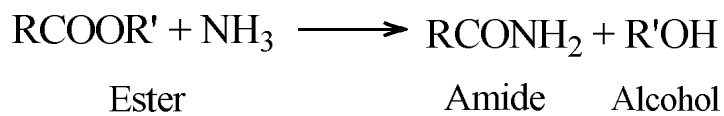

Mechanism

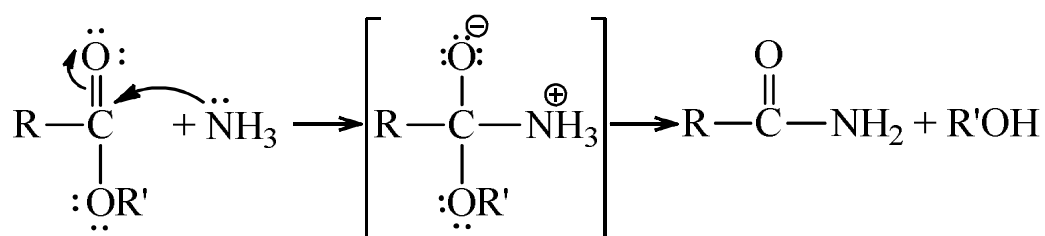

2. **Reduction of esters:** Esters get reduced to alcohol in the presence of Na and alcohol or LiAlH_4 .

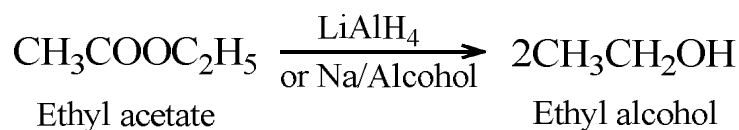
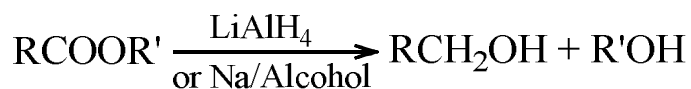

3. **Reaction with Grignard reagents:** Esters of formic acid gives secondary alcohols and those of other acid give tertiary alcohols on reaction with Grignard reagents.

Reaction between ethyl formate and methyl magnesium bromide

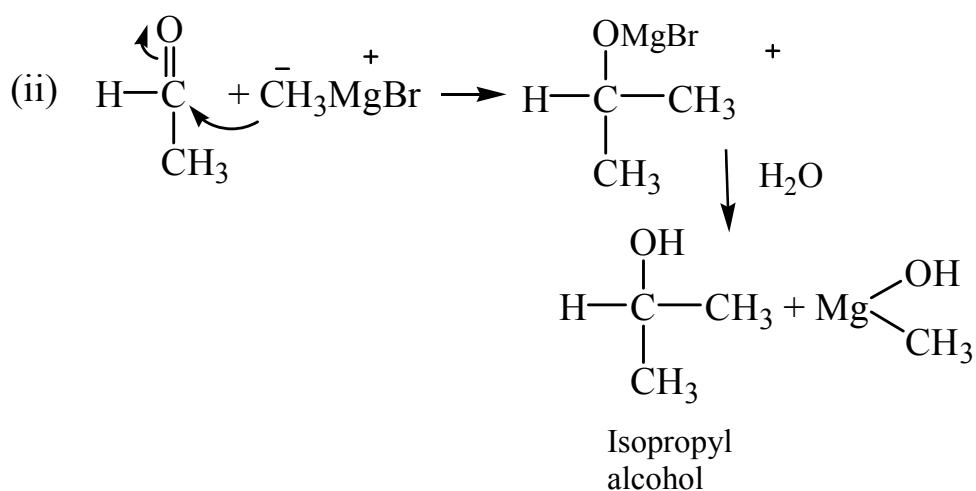
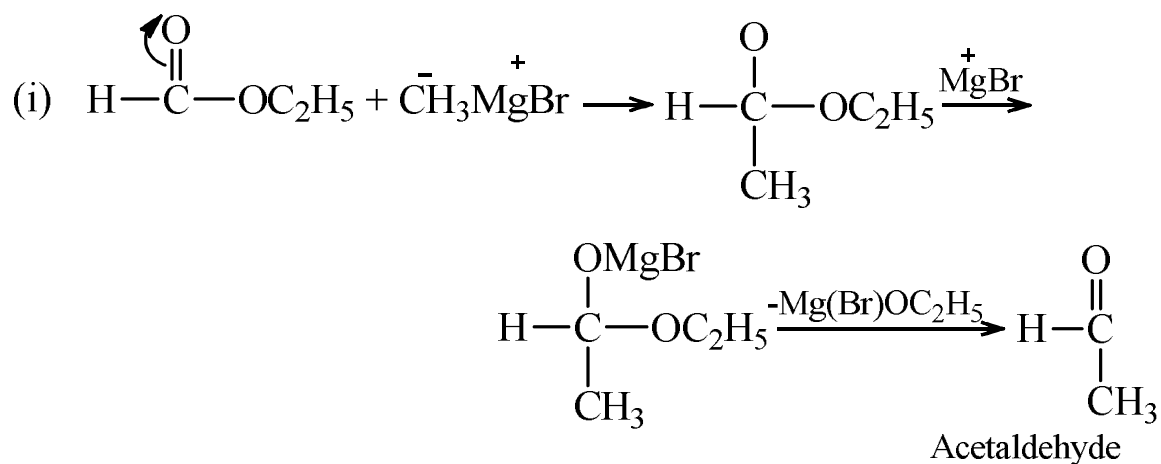

Reaction between Ethyl Acetate and methyl magnesium Bromide:

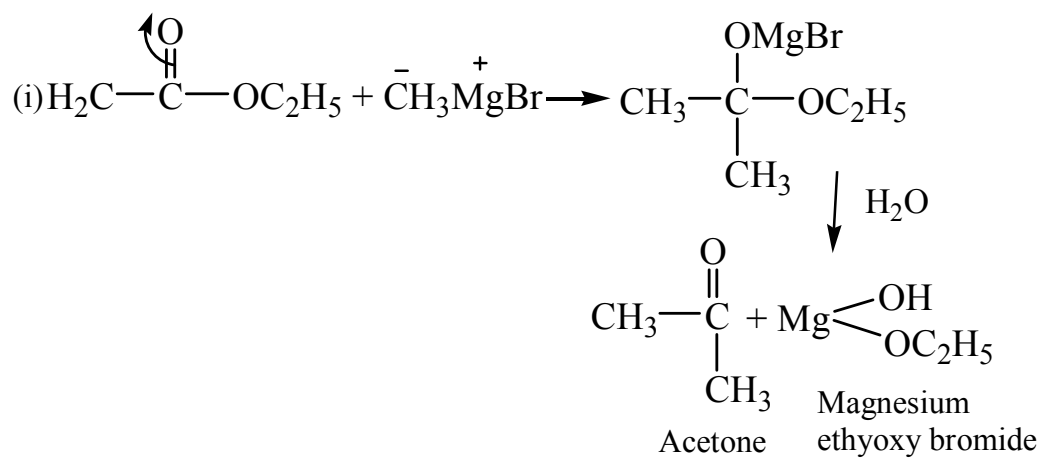

Mechanism (base catalyzed)

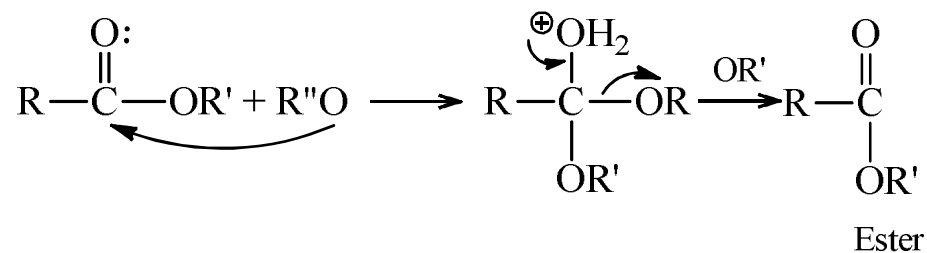
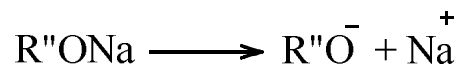

5.45 Mechanism of acid catalyzed and base catalysed hydrolysis of an ester

Both these reactions are acyl nucleophilic substitution reactions.

Acid catalyzed:

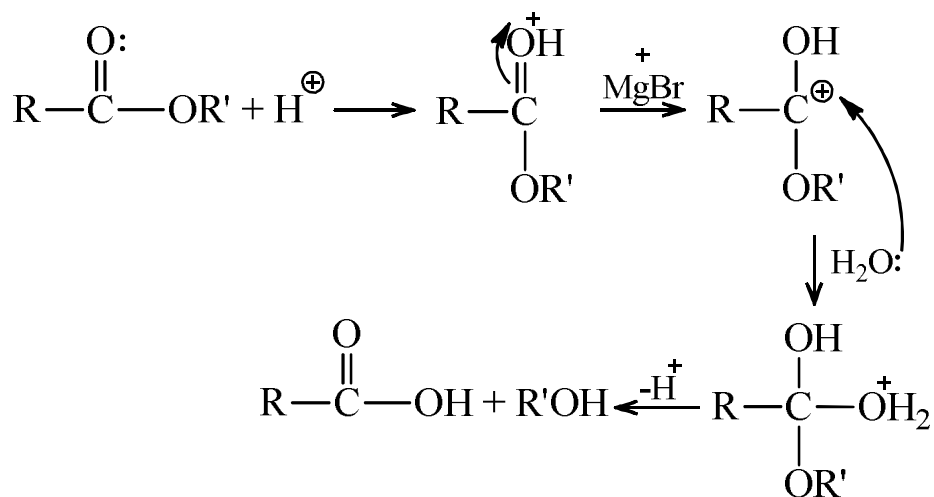

Base catalysed:

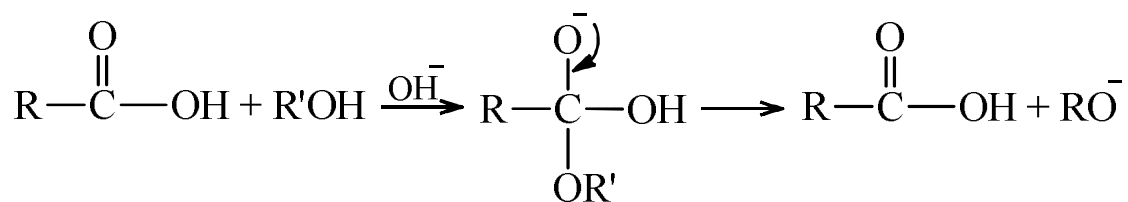

5.5 Acid anhydrides

General

Acid anhydrides are organic substances obtained by the dehydration of carboxylic acids.

Generally one water molecule is removed from the two molecules of monocarboxylic acid. In the case of dicarboxylic acids, one water molecule is taken out from one molecule of the acid. Thus

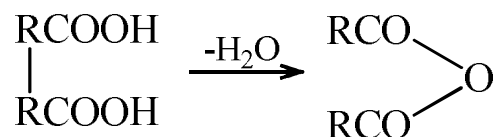

2 molecules
of the acid

Acid anhydride

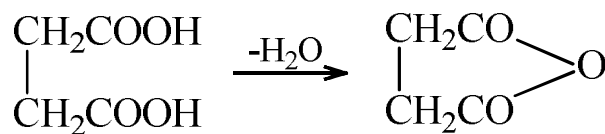

Succinic acid

Succinic anhydride

5.51 Nomenclature of acid anhydrides

Such compounds are named by adding the word “anhydride” after the name of the acid as indicated in Table 6.2

Table 6.2 common and IUPAC names of acid anhydrides

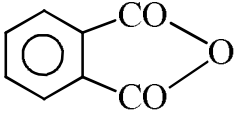
Compound	Common name	IUPAC Name
$\begin{array}{c} \text{CH}_3\text{CO} \\ \quad \diagdown \\ \quad \quad \text{O} \\ \quad \diagup \\ \text{CH}_3\text{CO} \end{array} \text{ or } (\text{CH}_3\text{CO})_2\text{O}$	Acetic anhydride	Ethanoic anhydride
$\begin{array}{c} \text{CH}_2\text{CO} \\ \quad \diagdown \\ \quad \quad \text{O} \\ \quad \diagup \\ \text{CH}_2\text{CO} \end{array}$	Succinic anhydride	Butanedioic anhydride
	Phthalic anhydride	O-Benzenedioic anhydride

5.52 Methods of preparation of acid anhydride

Following methods are used for the preparation of acid anhydrides:

- Dehydration:** Vapours of the acid are passed over phosphorus pentoxide.

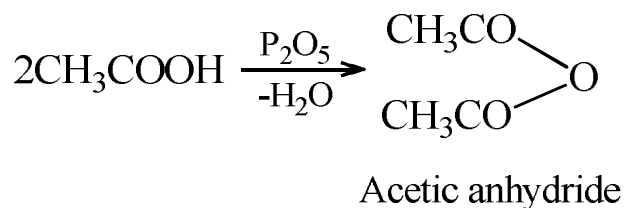
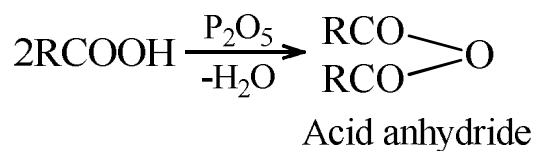

- By the action of acid chloride on the sodium salt of acid:**

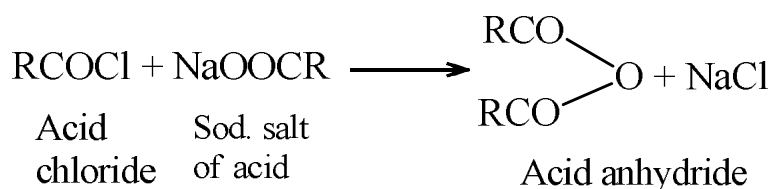

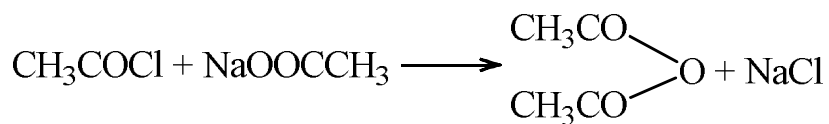

3. **By the combination of acid and ketone. This reaction takes place in two steps:**

Ketene is obtained when acetic acid is heated at 700° C

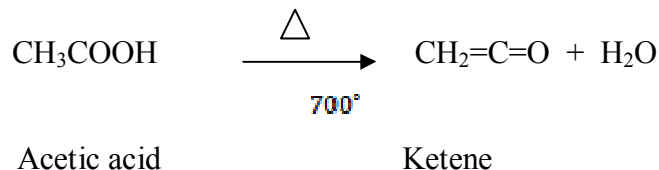

Ketene react with acetic acid to produce acetic anhydride

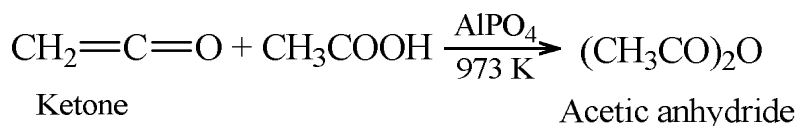

5.53 Properties of acid anhydrides

1. **Hydrolysis:** Acid anhydrides get hydrolysed by water to produce acids.

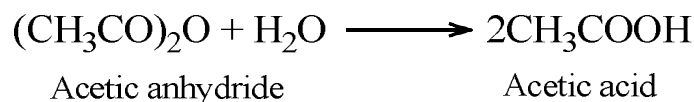

2. **Alcoholysis:** With ethyl alcohol, acetic anhydride reacts to form ethyl acetate.

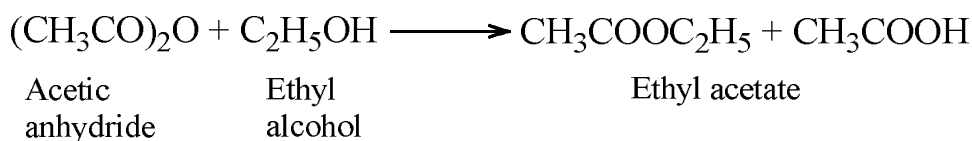

Better yield of the ester is obtained by this method.

3. **Ammonolysis:** Ammonia reacts with acetic anhydride to produce acetamide.

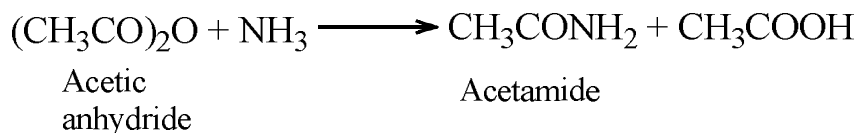

4. Action of primary amine:

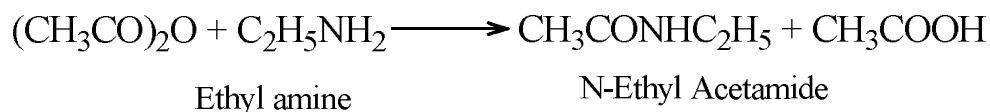

5. Action of PCl_5 for HCl : With either of these, acid chlorides are formed.

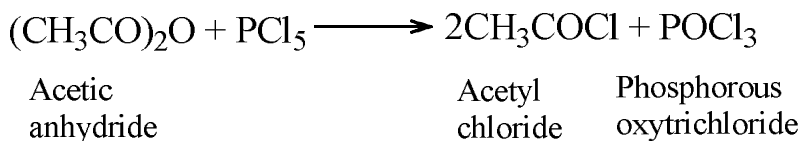

6. Reduction: Acid anhydride on reduction produces alcohols. Reducing agents used are sodium-alcohol or LiAlH_4 .

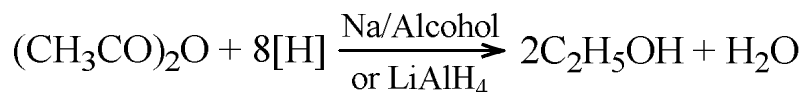

7. Friedel-Crafts acylation: Acetic anhydride can be used for acylating aromatic compounds in the presence of anhydrous AlCl_3 .

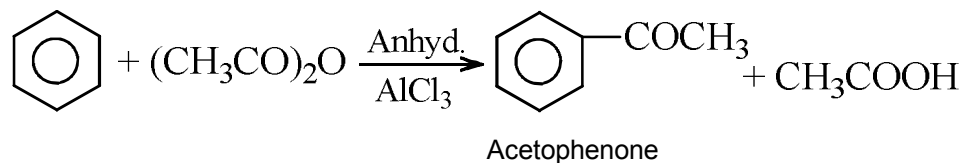

5.6 Acid amides: Nomenclature of acid amides

Acid amides are organic compounds having the general formula RCONH_2 , where R are stands for some alkyl or aryl group. These are acid derivatives as these compounds can be obtained from acid.

Nomenclature of acid amides

These compounds are obtained by replacing the $-OH$ group of the carboxylic acid $RCOOH$ by NH_2 group, Nomenclature of amides according to common system and IUPAC system are given in Table 6.3

Table 6.3 Common and IUPAC names of acid amides

Compound	Corresponding acid	Common name	IUPAC name
$HCONH_2$	$HCOOH$	Formamide	Methanamide
CH_3CONH_2	CH_3COOH	Acetamide	Ethanamide
$CH_3CH_2CONH_2$	CH_3CH_2COOH	Propionamide	Propanamide
$C_6H_5CONH_2$	C_6H_5COOH	Benzamide	Benzenamide

5.61 Method of preparation of amides

1. By the action of NH_3 on acid derivatives

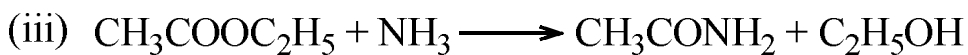
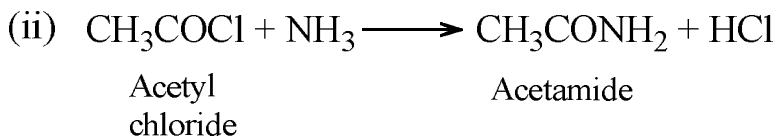
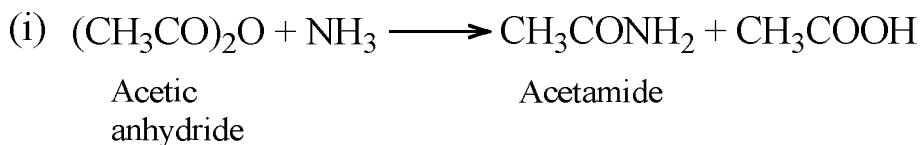

Mechanism

These are all nucleophilic substitution reaction.

Mechanism of the mechanism of the reaction below

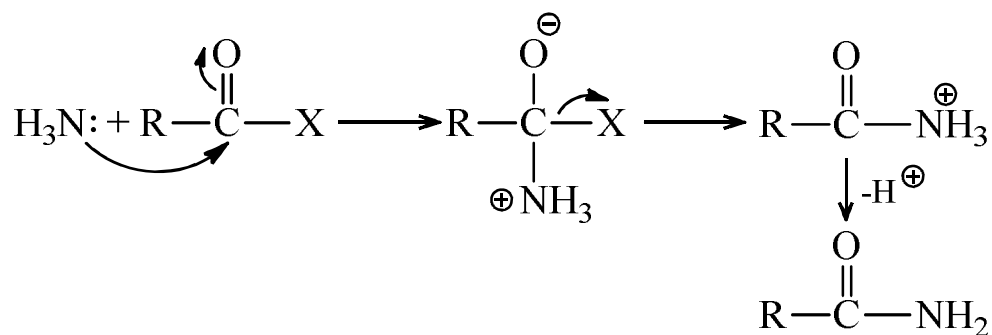

Stands for $-\text{OCOCH}_3$, $-\text{Cl}$ or OCH_2H_5 Group

2. **From ammonium salt:** ammonium salt of carboxylic acid on heating give amides

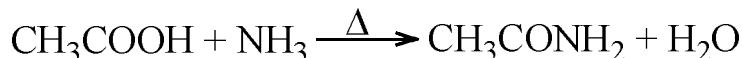
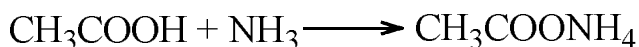

3. **Partial hydrolysis of cyanides:**

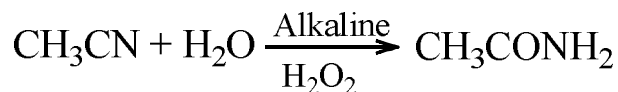

5.62 Properties of amides

1. **Hydrogen bonding:** There is intermolecular hydrogen bonding between amide molecules. This leads to higher boiling points of amides hydrogen bonding involve H-O bonds as shown below

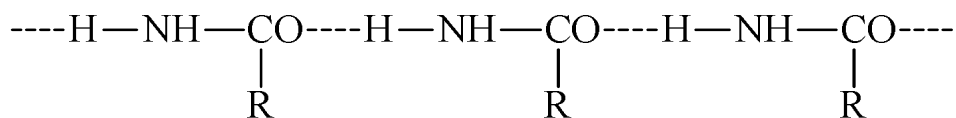

2. **Reactivity:** Acid amides are quite reactive towards nucleophilic substitution point this is because of the positive charge on acyl carbon atom. Which is so necessary for nucleophilic substitution and the intermediate compound is stabilized as shown below

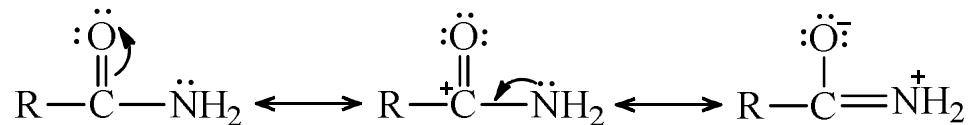

3. **Amphoteric nature:** Amides are neutral to limits. These show weakly acidic as well as basic properties

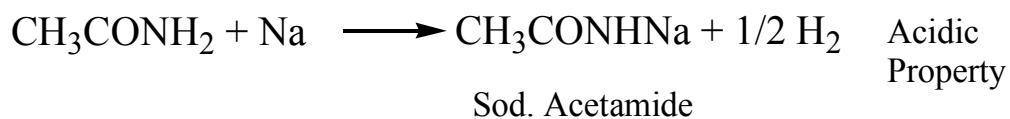
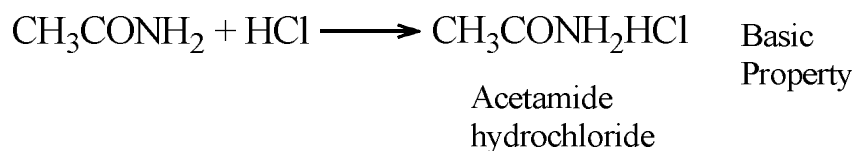

The low basicity is because of the following transition:

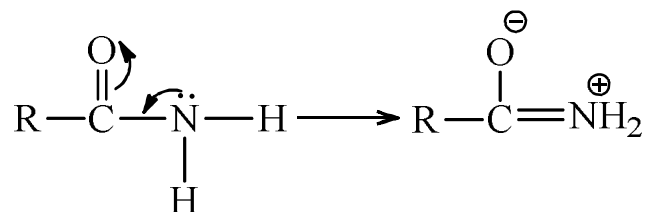

4. **Hydrolysis:** They are hydrolyzed to parent acids in the presence of mineral acid or alkali

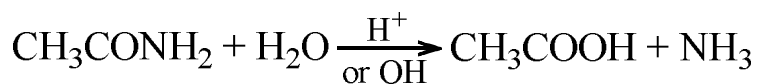

Mechanism (In the presence of an acid)

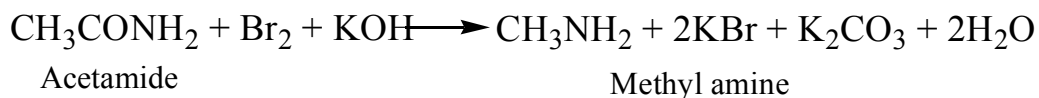

For mechanism see chapter on amines

5.7 Acid chloride: Nomenclature of acid chloride

Acid chloride are organic compounds having the general formula RCOCl where R stands for some alkyl or aryl group. These are acid derivatives and can be obtained by subtracting $-\text{OH}$ Group of the carboxy acid by $-\text{Cl}$ group. This can also be obtained replacing $-\text{NH}_2$, $-\text{COCOR}$ or $-\text{OR}$ group by $-\text{Cl}$

Nomenclature of acid chloride

Nomenclature of acid chloride according to common and IUPAC system is given in table 6.4

Table 6.4 Common and IUPAC names of acid chlorides

Acid chloride	Corresponding acid	Common chloride	IUPAC Name
HCOCl	HCOOH	Formyl chloride	Methanoylchloride
CH_3COCl	CH_3COOH	Acetyl chloride	Ethanoylchloride
$\text{CH}_3\text{CH}_2\text{COCl}$	$\text{CH}_3\text{CH}_2\text{COOH}$	Propionyl chloride	Propanoyl chloride
$\text{C}_6\text{H}_5\text{COCl}$	$\text{C}_6\text{H}_5\text{COOH}$	Bezoyl chloride	Benzene carbonyl chloride

5.71 Method of preparation of acid chloride

1. **Using PCl₅ or PCl₃:** Acid chloride can prepared by action of PCl₅ OR PCl₃ on carboxylic acid

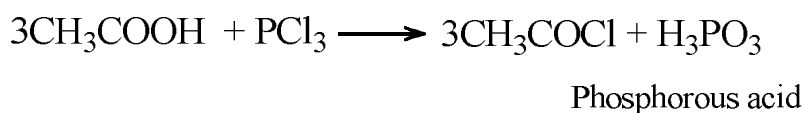
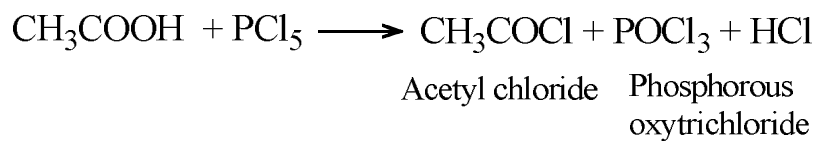

2. **By the action of thionyl chloride on carboxylic acid:**

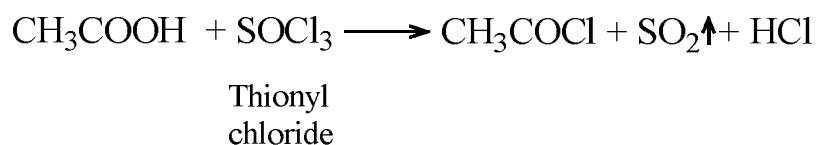

3. **By the action of PCl₃ thionyl Chloride on sodium or calcium salts of fatty acid.**

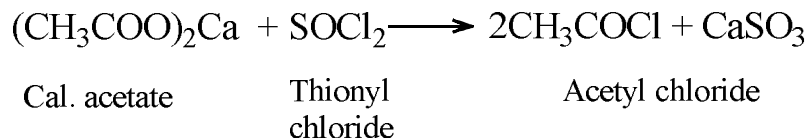
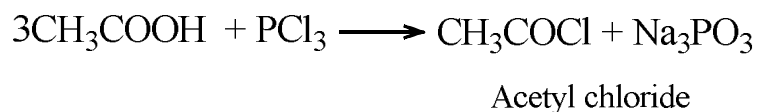

5.72 Properties of acid chloride

Acid chlorides are the most reactive of carboxylic acid derivatives. They undergo nucleophilic substitution reactions important reactions of acid chlorides are given below

1. **Hydrolysis:** Acid chlorides are hydrolyzed by water to form the present carboxylic acids.

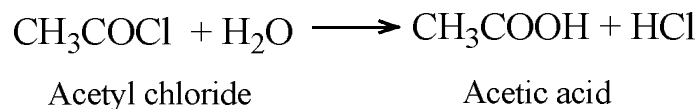

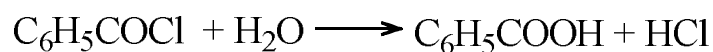

Benzoyl chloride

Benzoic acid

Mechanism of reaction is as follows:

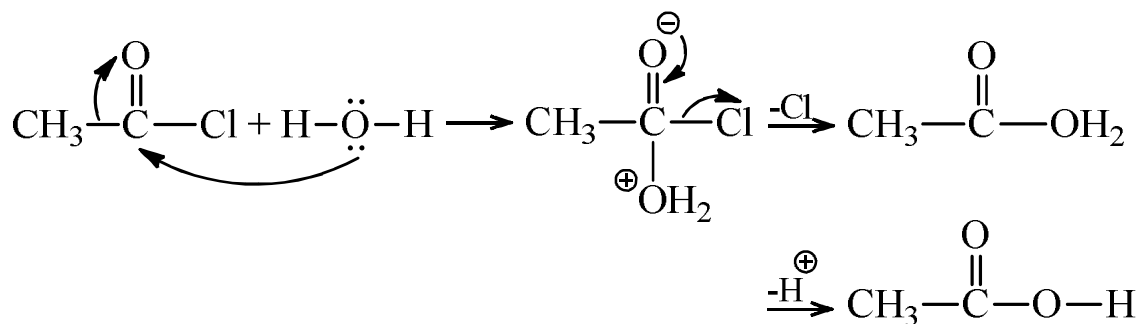

2. Reaction with alcohol and acid chloride reacts with alcohol to form an ester.

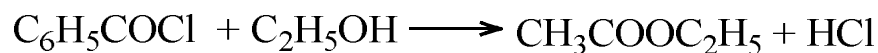

The reaction takes place as a nucleophilic substitution with the following **Mechanism:**

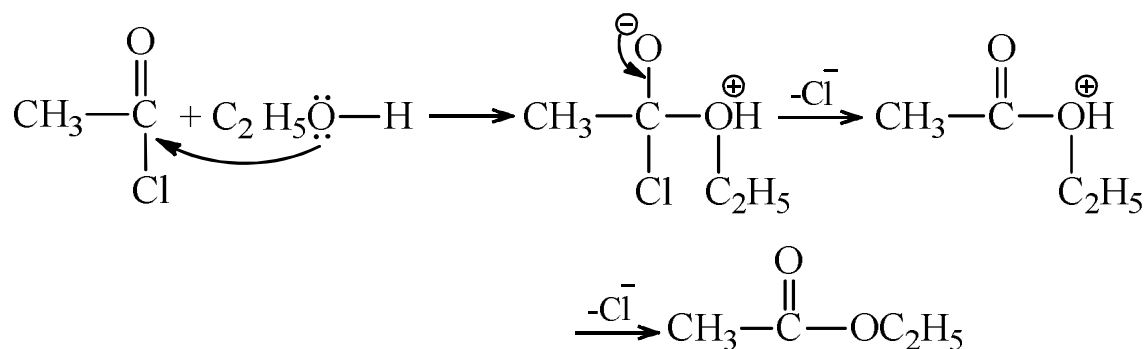

3. **Ammonolysis:** An acid chloride reacts with Ammonia to form an amide.

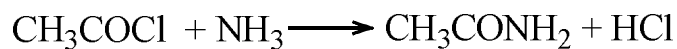

Acetyl chloride

Acetamide

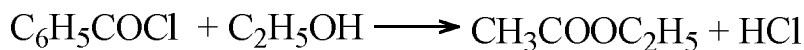

Benzoyl chloride

Benzamide

Mechanism of the reaction is given below: It is again a nucleophilic substitution reaction.

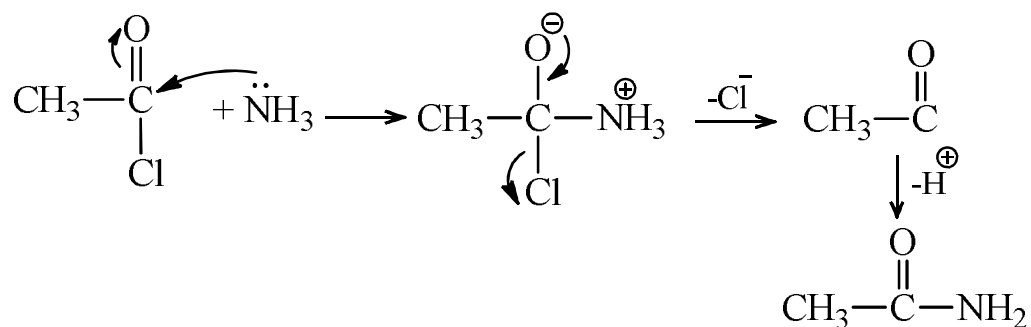

4. **Reaction with amines:** and acid chloride on reaction with an amine give substituted amide.

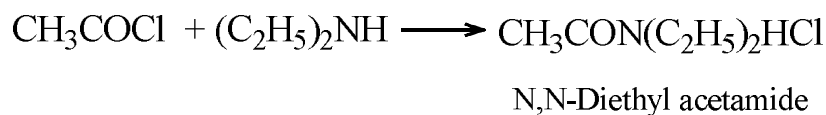
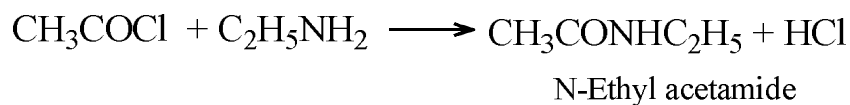

5. **Formation of acid anhydride:** There is a reaction with sodium salt of fatty acid and acid anhydride is obtained.

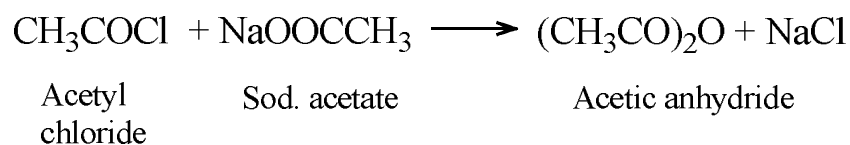

6. **Reaction with Grignards reagent:**

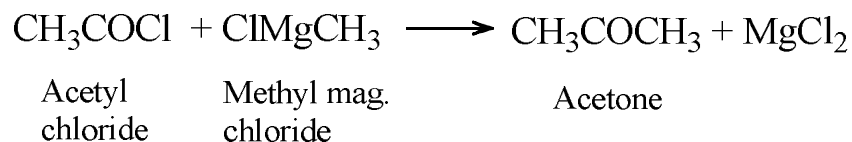

7. Reaction with organocadmium compound:

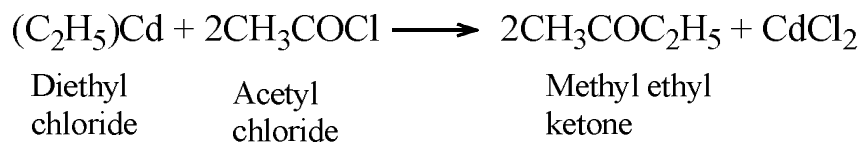

8. Rosenmund's reduction: hydrogenation of an acid chloride in the presence of palladium based on BaSO_4 using xylene as a solvent gives aldehyde.

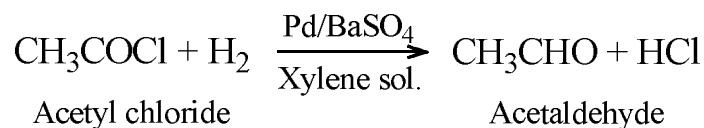

9. Friedel-Crafts reaction:

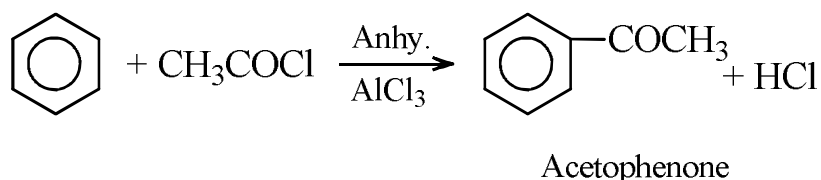

10. Action with halogens: treatment with the halogen brings about substitution at the alkyl group. Alpha hydrogen atoms undergo substitution with halogen as shown below:

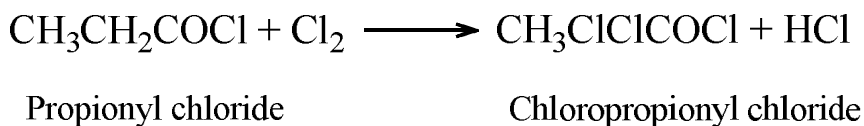

11. Reaction with carboxy acid: an acid chloride reacts with carboxylic acid in the presence of an acid chloride reacts with a carboxylic acid in the presence of pyridine to produce acid anhydride.

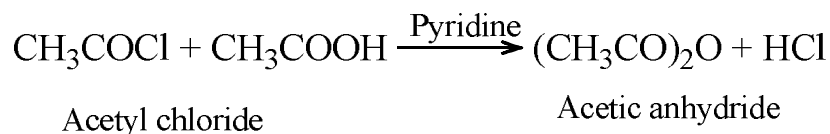

5.8 Urea: Methods of preparation of urea

Historical importance

It is the end product of human metabolism of Nitrogen containing foods (proteins). In 1773, Roulle isolated it from urine and name it urea. It has historical significance as it was the first organic compound synthesized in the laboratory (Wohler 1828) from inorganic material.

Methods of preparation of urea

Methods of preparation of urea are described as under:

1. **From urine:** urine is evaporated to a small bulk and nitric acid is added to it to precipitate sparingly soluble urea nitrate ($\text{NH}_2\text{CONH}_2\cdot\text{HNO}_3$). Urea nitrate is treated with barium carbonate to remove the acid and then extracted with alcohol, barium nitrate being insoluble in alcohol.



2. **By heating a solution containing a mixture of potassium cyanate and Ammonium Sulphate to dryness (Wohler synthesis):** When this mixture is heated to dryness, ammonium cyanate which undergoes molecular rearrangement (isomeric change) to give urea. Urea is extracted from this mixture by dissolving in hot absolute alcohol. Ammonium sulphate being in soluble may be filtered off and the filtrate on cooling deposits urea

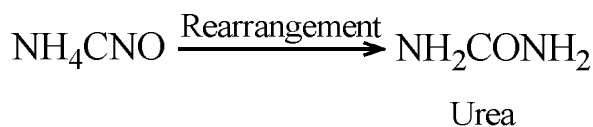
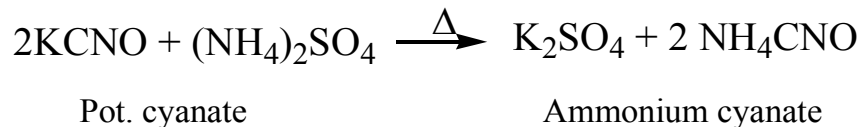

3. **By partial hydrolysis of cyanamide (Manufacture):** Cyanamide for this purpose is obtained from calcium cyanamide which is manufactured by passing nitrogen through heated calcium carbide at about 1073 K.

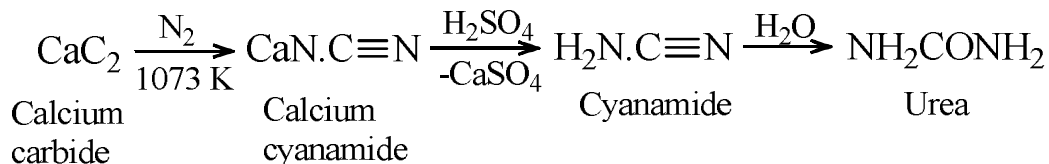

4. **By the action of ammonia on carbonyl chloride (Laboratory preparation):**

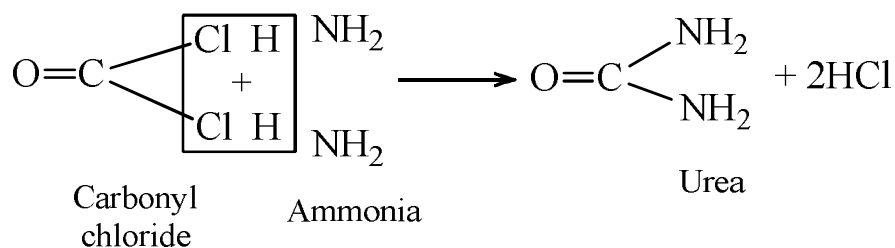

5. **By the action of liquid carbon dioxide on liquid ammonia at 423 K and 35 atmospheric pressure (Manufacture).**

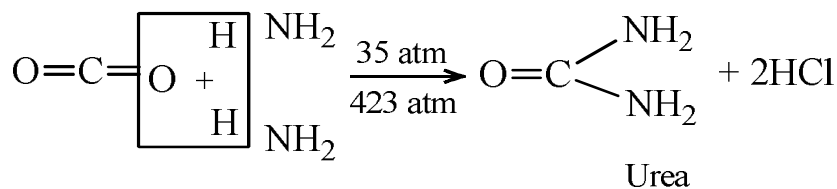

5.81 Properties of urea

Physical properties of urea

Urea is white crystalline solid. It melts at 405 K. It is soluble in water and ethyl alcohol but insoluble in ether. It is odourless and has a metallic taste.

Chemical properties of urea

Urea contains an amide group attached to an amino group and give reactions of both these groups.

1. **Basic nature (salt formation):** An aqua solution of urea is neutral to litmus but behaves as a weak mono acid base and forms salt with strong acids. Thus, when nitric acid is added to a strong solution of urea, a crystalline precipitate of urea nitrate is formed.

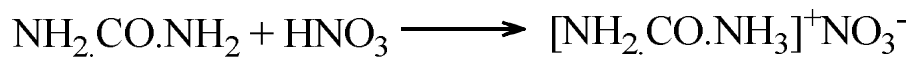

2. **Hydrolysis:** It is rapidly hydrolysed into Ammonia and carbon dioxide when boiled with dilute acid or alkalis.

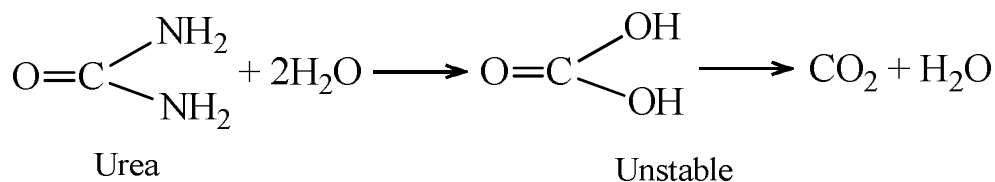

Thus upon hydrolysis with dilute hydrochloric acid urea forms ammonium chloride and with caustic soda it forms sodium carbonate.

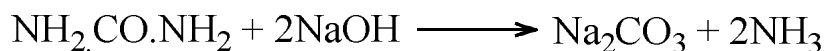

Enzyme, urease also brings about the hydrolysis of urea.

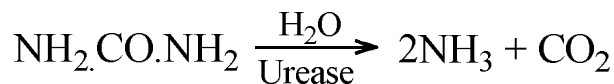

3. **Reaction with nitrous acid:** Urea reacts with nitrous acid to produce carbon dioxide, nitrogen and water.

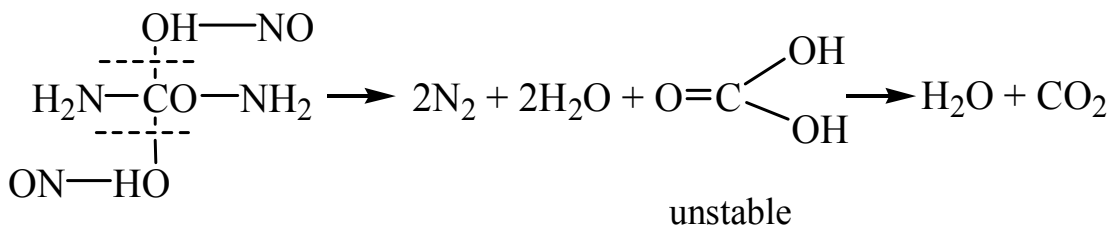

4. **Acetylation:** Urea undergoes acetylation with acetyl chloride.

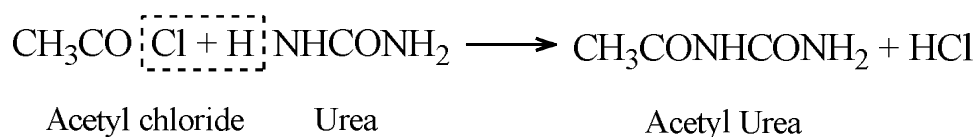

5. **Reaction with sodium hypohalites:** With excess of alkaline sodium hypobromite, urea is converted to nitrogen and sodium carbonate.

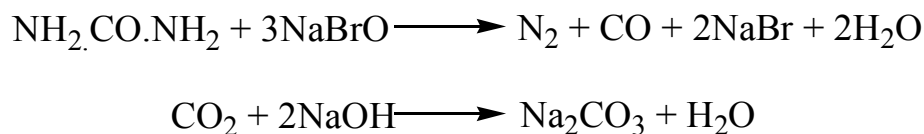

6. **Action of heat:**

a. On heating gently at about 405 K urea melts and after evolution of ammonia, a solid compound called biuret is produced.

Biuret contains $-\text{CO}-\text{NH}-$ group and hence give a violet coloration with alkaline dilute copper sulphate solution.

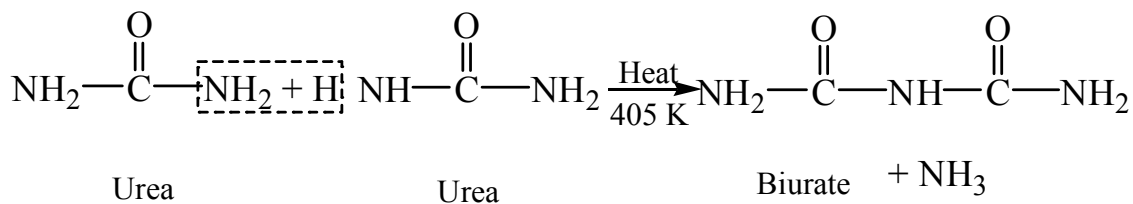

b. When heated rapidly: ammonia is liberated and isocyanic acid is produced which trimerizes to cyanuric acid.

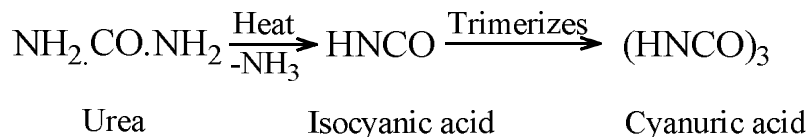

7. **Reaction with formaldehyde:** urea reacts with formaldehyde to form urea formaldehyde resin or plastics.

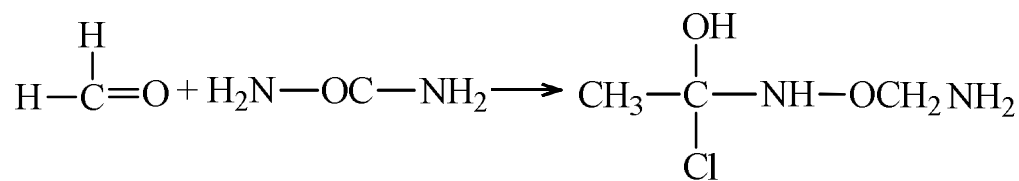

Methyl Urea

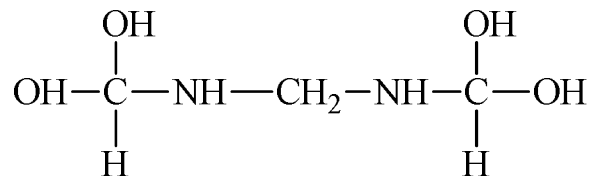
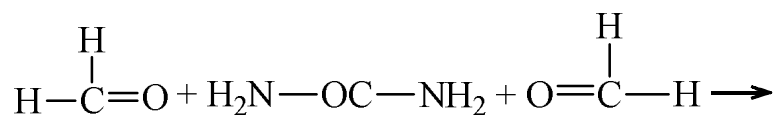

Dimethyl Urea

As the end $-\text{CHOH}$ Groups for the react with $-\text{NH}_2$ the chain grows in length. Again the $-\text{NH}-$ group formaldehyde which gives rise to cross linkages forming valuable polymers.

Uses of urea: It is used:

1. In the manufacture of formaldehyde- urea plastic or resins.
2. As a stabilizer for explosives.
3. For making barbiturates used as hypnotics and sedatives.
4. As a fertilizer.

5.82 Estimation of urea

Two methods are generally employed for the estimation of urea: (a) the hypobromite method; and (b) urease method. These are described as under:

1. **The Hypobromite method:** This is a very rapid and sufficiently accurate method for medical requirements. known volume of urine (or urea solution) is treated with sodium hypobromite solution containing an excess of sodium hydroxide.

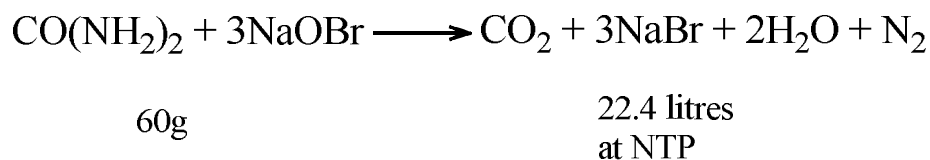

The carbon dioxide evolved is absorbed by Sodium Hydroxide and the volume of Nitrogen evolved is measured in the nitrometre. As shown by the chemical equation 22.4 liters of nitrogen at NTP produced by 60 g of urea. Therefore, the amount of Urea in the sample of urine is calculated as:

$$= \frac{60}{22400} \times V \text{ grams}$$

Where V is the volume of Nitrogen gas (reduced to NTP conditions) in the nitrometer.

Procedure: Place about 30 ml of freshly prepared sodium hypobromite solution containing excess of NaOH in 250 ml conical flask (Fig .6.1). Measure urine into the small test- tube and with the rubber stopper securely. adjust water to the same level in the two limbs of nitro metre. Fill the flask so that the urine and hypobromite solution come into contact. The reaction starts and nitrogen collects in the nitro meter while CO₂ is absorbed by excess of sodium hydroxide in the flask. The volume of N₂ is noted again by adjusting the water levels in the nitro meter. It is reduced to NTP.

2. **The Urease Method:** This method is based on the conversion of Urea to ammonium carbonate by hydrolysis with urease (soya bean extract). The ammonium carbonate solution so produced is estimated by titration with N/10 HCl.

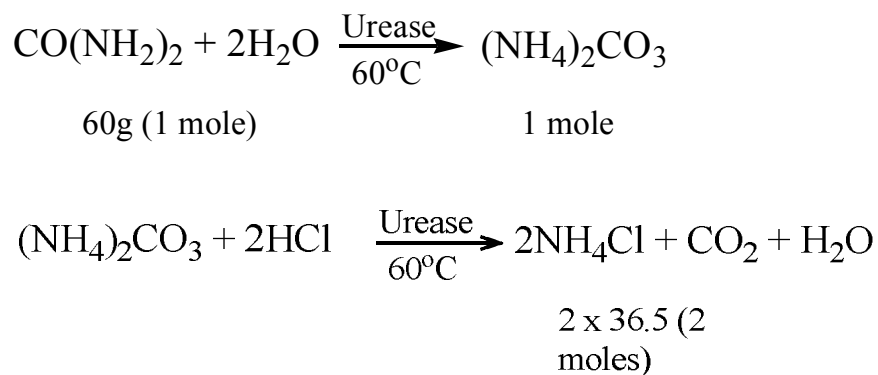

From the volume of N/10 of HCl used by unknown weight of the sample, the amount of Urea can be calculated as under:

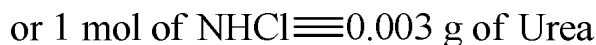
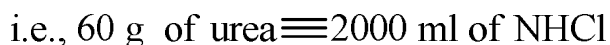
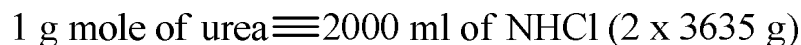

Procedure: Weigh accurately about 0.1 g of the crude urea in a 250 ml flask. Add to 820 ml of warm water to bring the temperature to 60 degree Celsius (optimum condition for urease). Add 3 drops of phenolphthalein and 10 ml of urease solution when the solution turns pink. Now add to it N/10 HCl dropwise till the pink colour is just discharged. This gives a pH of about 8. Continue to add acid carefully so as to keep the color discharged/ the reaction (hydrolyses to ammonium carbonate) is complete in about 5 minutes. The resulting solution is then titrated again N/10 HCl using methyl orange as indicator. The volume of the acid used in noted and calculations are made as shown above.

5.9 Terminal Questions

1. Give the reaction and reagent for the formation of acetyl chloride.
2. Complete the following:

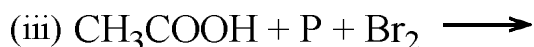
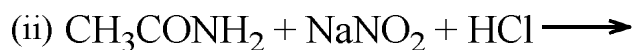
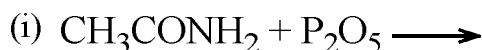

3. Write down the product of the reaction:

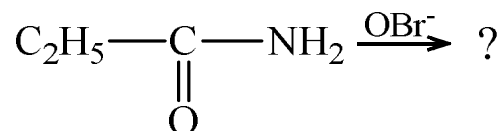

4. Which of the following can be most easily hydrolysed and why?
 - a. $(\text{CH}_2\text{CO})_2\text{O}$
 - b. CH_2COCl

c. CH_3CONH_2

d. $\text{CH}_3\text{COOC}_2\text{H}_5$

5. Complete the following:

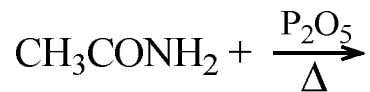

6. Complete the following:

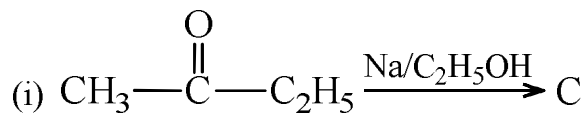

7. Which of the following can be most easily hydrolyzed and why?

CH_3COCl , $\text{C}_2\text{H}_5\text{Cl}$, $(\text{CH}_3\text{CO})_2\text{O}$, CH_3CONH_2

8. Discuss the order of ease of hydrolysis of:

a. Acid chlorides

b. Esters

c. Acid amides

d. Acid anhydrides

9. Why acetic anhydride is preferred to acetyl chloride for acetylation reaction?

10. Complete the following:



11. Write briefly why CH_3CONH_2 is acidic in nature.

12. Starting with malonic Ester, how will you prepare succinic acid?

13. Why acetyl chloride is more reactive than acetamide?

14. How would you prepare ethyl amine by Hoffmann degradation of amides?

15. How will you convert an acid chloride into an amide, an ethyl ester and an amine?

16. Which of the following can be hydrolysed most easily and why?

Acetic anhydride, acetyl chloride, acetamide and ethyl acetate.

17. Write a short note on Hoffman's Bromamide reaction.

18. Complete the following reactions:

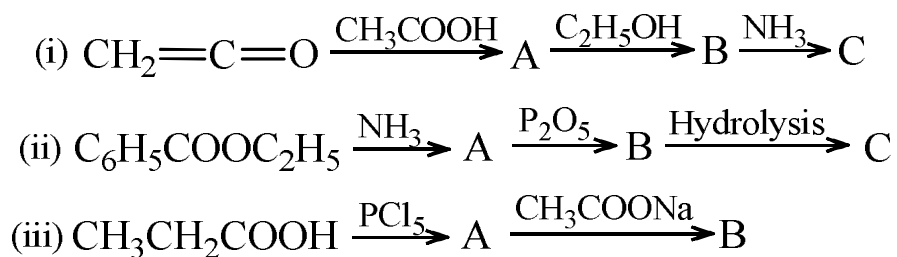

19. Write a short note on trans-esterification.
20. Why does acetyl chloride get hydrolysed more easily than ethyl acetate? Explain.
21. Explain the following:
 - a. Trans-esterification
 - b. Amphoteric nature of amides.
22. Give the mechanism of alkaline hydrolysis of esters.
23. Account for: acid halides are most reactive of all the acid derivatives.
24. Give the mechanism of esterification.
25. How does the presence of electron- donor group retard the rate of basic hydrolysis?
26. Give the mechanism of esterification.
27. Discuss Hofmann's bromamide reaction of amides. Give its mechanism.
28. Discuss amphoteric behaviour of amides.
29. Give reasons why acetamide is hydrolysed very slowly with water but rapidly in the presence of an acid or alkali?
30. Discuss the mechanism of hydrolysis of ethyl acetate.
31. Outline the mechanism of laboratory preparation of ethyl acetoacetate.
32. What is esterification? Discuss its mechanism.

Unit-6: Organic Compounds of Nitrogen

6.1 Introduction

Objectives

6.2 Nomenclature of nitro compounds

6.3 Methods of Preparation of Nitroalkanes of Aliphatic Nitro Compounds

6.4 Physical properties of nitro compounds

6.5 Chemical properties of nitroalkanes

6.6 Methods of Preparation of Aromatic Nitro Compounds are given below

6.7 Physical Properties of Aromatic Nitro Compound

6.8 Chemical Properties

6.9 Halogen Nitro Compounds

6.10 o-, m-, p- Nitroaniline

6.11 2,4,6 Trinitrophenol (Picric Acid)

6.12 Classification of Amines

6.13 Nomenclature of Amine

6.14 Structure and shape of amine molecules

6.15 Method of Preparation of Amines

6.16 Distinction between Primary, Secondary and Tertiary Amines

6.17 Basicity of Amines

6.18 Explanation of Relative Basicity

6.19 Effect of Substitutions on the Basicity of Aromatic Amines

6.20 Exhaustive Methylation of Amines and Hoffman's Elimination

6.21 Cope Elimination

6.22 Amine Salts as phase transfer catalyst

6.23 Structure of Benzene Diazonium Chloride

6.24 Laboratory Preparation of Benzenediazonium Chloride

6.25 Diazomethane

6.26 Terminal Question

6.1 Introduction

Nitro compounds are the compounds which contain at least one nitro group ($-\text{NO}_2$) in the molecule e.g. nitro methane (CH_3NO_2) nitrobenzene ($\text{C}_6\text{H}_5\text{NO}_2$) etc.

Structure Of Nitro Group: Nitro group has the structure.

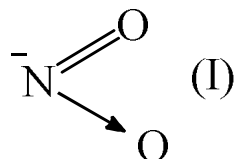

Thus there is one nitrogen-oxygen double bond and one nitrogen-oxygen co-ordinate bond. It is also represented as:

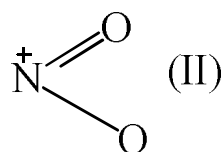

Structure II contribute to a greater extent to the actual structure of nitro groups as it is resonance stabilized:

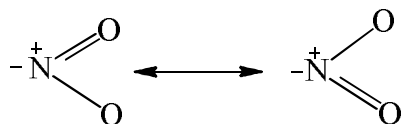

The above two resonating structure have equal energies. This imparts extra stability to the structure of nitro groups. Single and double bonds exchange their positions, hence single structure of NO_2 group could be written as

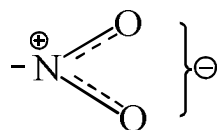

Orbital diagram of nitro groups is represented as.

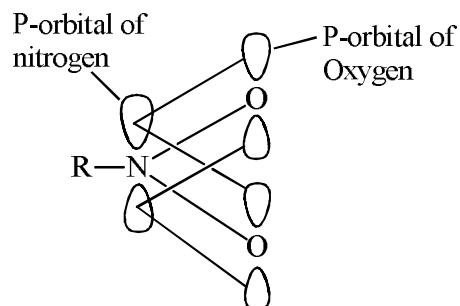

Difference between nitro and nitrite group:

Consider the following two compounds.

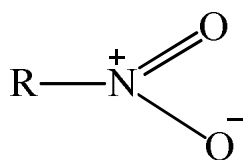

(a)



(b)

Out of the two compounds (a) is a nitro compound whereas compound (b) is nitrite. The difference between the two is obvious.

In a nitro compound, the alkyl (or any I) group is directly linked to the nitrogen atom, whereas in the nitrite, the alkyl group is linked to oxygen.

Some points of distinction between nitro compounds and nitrites are given in the table below.

Distinction between Nitroalkenes and Alkyl nitrites.

No.	Property	Nitro Alknae	Alkyl Nitrite
1.	Boiling point	High	Low
2.	Reduction Sn/HCl	Primary amine is formed $\text{RNO}_2 + 6\text{H} \xrightarrow{\text{Sn/HCl}} \text{RNH}_2 + 2\text{H}_2\text{O}$	Alcohol is formed $\text{RNO}_2 + 4\text{H} \xrightarrow{\text{Sn/HCl}} \text{ROH} + \text{NH}_2\text{OH}$
3.	Action of alkalis	Salt formation takes place $\text{RCH}_2\text{NO}_2 + \text{NaOH} \longrightarrow \text{RCHNaNO} + \text{H}_2\text{O}$	Hydrolysis takes place with the formation of alcohol $\text{RNO}_2 + 4\text{H} \longrightarrow \text{ROH} + \text{NH}_2\text{OH}$
4.	Action of HNO ₂	Nitrolic acid is formed $\text{RCH}_2\text{NO} + \text{HNO}$ $\text{R}-\overset{\text{ }}{\text{C}}-\text{NO}_2 + \text{H}_2\text{O}$ NOH	No Action

6.2 Nomenclature of nitro compounds

Nitro compounds are named by adding the word nitro before the name of parent compound. Nitro compounds may be divided into categories viz, aliphatic nitro compounds and aromatic nitro compounds. The nomenclature of compounds from both categories is given below.

Aliphatic Nitro Compounds

Compounds	Name
CH ₃ NO ₂	Nitromethane
CH ₃ CH ₂ NO ₂	Nitroethane
CH ₃ CH ₂ CH ₂ NO ₂	1-Nitropropane
$\begin{array}{c} \text{CH}_3\text{CH}_2\text{CH}-\text{CH}_3 \\ \\ \text{NO}_2 \end{array}$	2-Nitrobutane

Aromatic nitro compounds

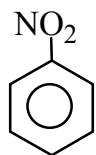

Nitrobenzene

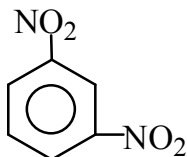

m-dinitrobenzene

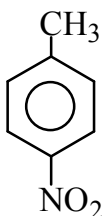

p-toluene

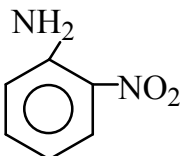

o-nitroaniline

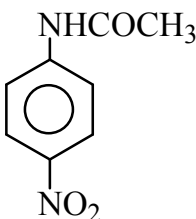

p-nitroacetanilide

6.3 Methods of Preparation of Nitroalkanes of Aliphatic Nitro Compounds

1. **Nitration of alkanes:** It is carried out by heating the alkane with nitric acid in vapour phase at 100K. One hydrogen of the alkanes is replaced by nitro group.



However, the reaction does not give single products in pure state. At high temperature of 700K, hydrocarbons are broken into smaller fragments and consequently i.e. obtain a mixture of different nitroalkanes.

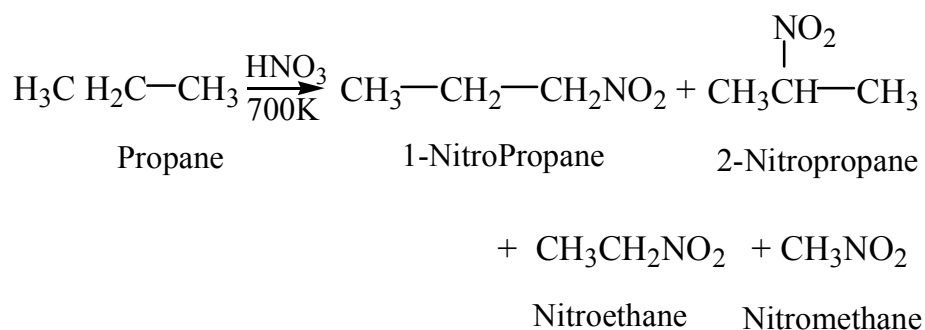

2. **Action of nitrous acid on α -halogen acid:** On boiling an aqueous solution of sodium nitrite with an α -halogen carboxylic acid nitroalkane is obtained.

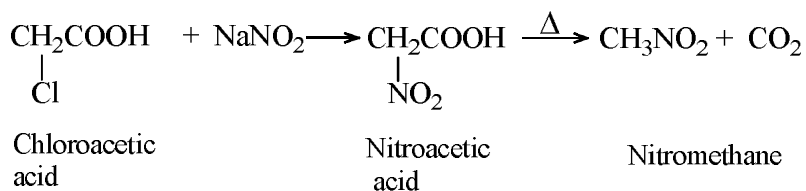

3. **Action of silver nitrite on alkyl halide:** Alkyl halides undergo nucleophilic substitution with silver nitrite to yield nitroalkanes.

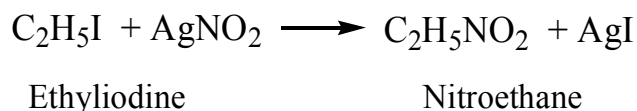

4. **Oxidation of amines:** An amino group attached to a tertiary carbon atom is oxidized with potassium permanganate to give nitroalkanes.

5. **Hydrolysis of a nitroalkenes:** A nitroalkene on hydrolysis in the presence of an acid or alkali produces nitroalkane.

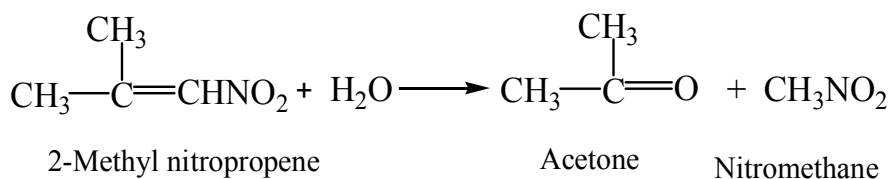

6. **Oxidation of amines:** Aldoximes and ketoximes on oxidation with trifluoroxy

Acetic acid yield primary and secondary nitroalkanes respectively.

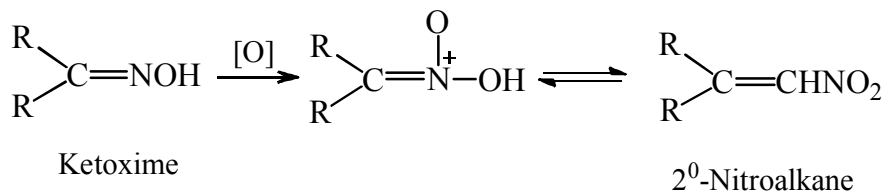
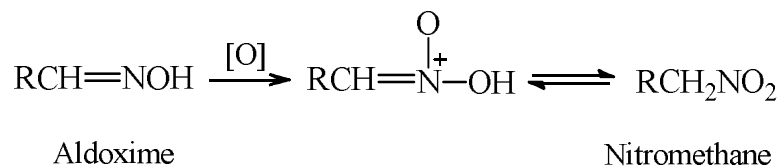

6.4 Physical properties of nitro compounds

- Physical state:** Pure Nitroalkanes are colorless oily liquids.
- Smell:** They have a pleasant smell.
- Solubility and density:** Nitroalkanes are sparingly soluble in water. These compounds have density more than one i.e. they are heavier than water.
- Boiling points:** Nitro compound have strong dipole interaction the dipole moment is of the order of 3-4D, consequently they possess higher boiling point than hydrocarbons of compatible molecular masses, However most of them are steam volatile.

6.5 Chemical properties of nitroalkanes

- Acid nature of nitroalkanes (tautomerism):** Nitroalkanes containing a hydrogen atom exhibit acidic behavior and form salt with strong alkalis.

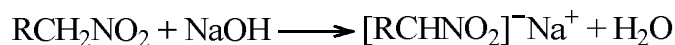

Acidic nature of hydrogen in nitro alkanes is due to the electron withdrawing inductive effect and -NO₂ group anion obtained after releasing one proton gets resonance stabilized.

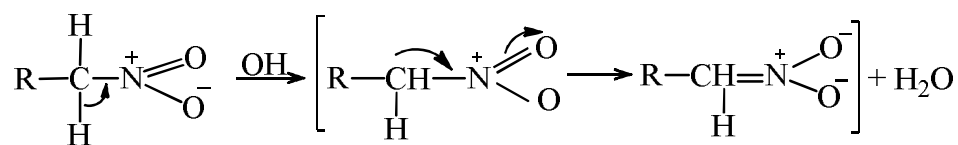

Primary and secondary nitroalkanes exhibit tautomerism. It forms being nitro forms and acinitro form.

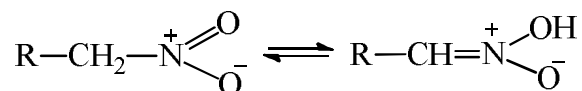

2. **Reduction:** Nitroalkanes on reduction under different conditions give different products.

a. In acidic medium:

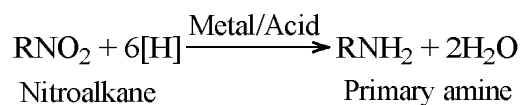

b. Catalytic reduction:

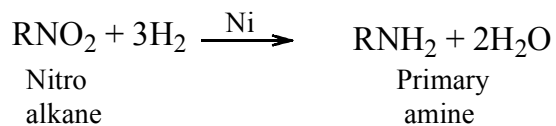

c. In neutral reducing medium

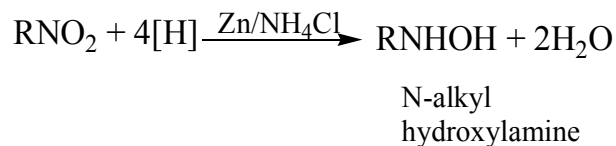

d. With SnCl_2 and HCl

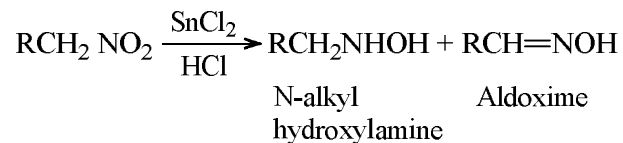

3. Hydrolysis

- a. Primary nitro compounds on boiling with HCl are converted into a mixture of carboxylic acid and hydroxylamine.



- b. Secondary nitroalkanes are hydrolysed to ketones on boiling with HCl

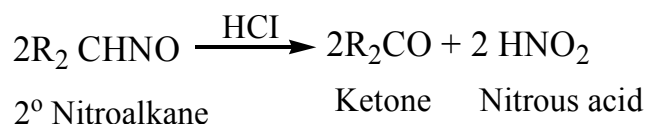

Tertiary nitroalkanes are not hydrolysed by acid

4. **Reaction with nitrous acid:** (a) primary nitroalkanes react with nitrous acid to form nitrolic acid which dissolves in alkali to give a red coloured solution

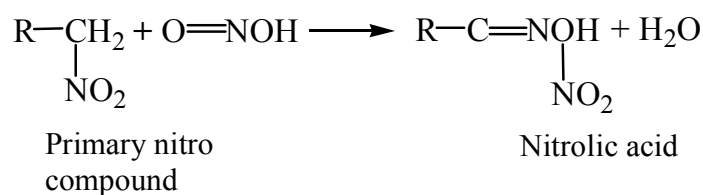

- (b) Secondary nitroalkanes react with nitrous acid to produce pseudo nitroles which give a blue colour with alkali

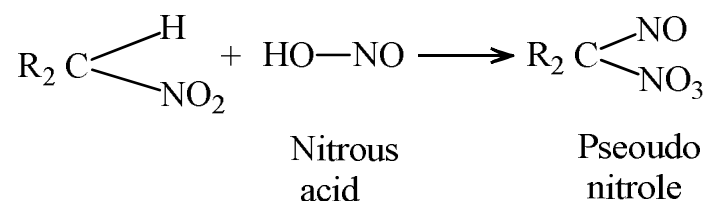

Tertiary nitroalkanes do not react with nitrous acid since they do not contain any α -hydrogen atom

5. **Halogenations** primary and secondary nitrite compounds having α -hydrogen atoms are halogenated in alkaline solutions.

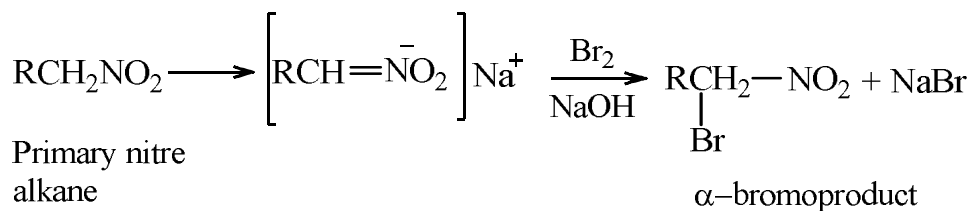

Nitromethane has 3-**alpha** hydrogen atoms and gives tri-halogen product

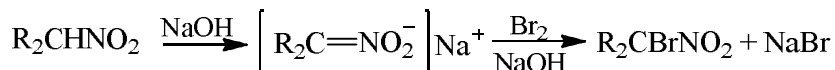

6. **Reaction with Grignard Reagent** acidic form of nitro alkene react with Grignard reagent as follows

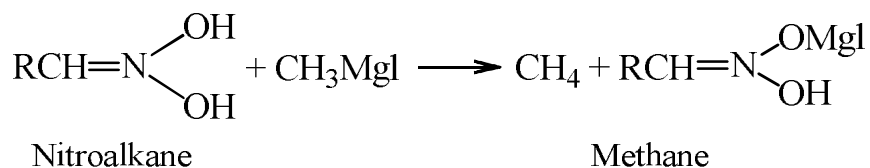

7. **Action of heat : Nitroalkanes on heating at 573 K produce alkenes.**

8. **Condensation with aldehyde: Primary and secondary nitroalkanes undergo aldol type reaction with aldehyde and ketone in the presence of a base to form nitro alcohol.**

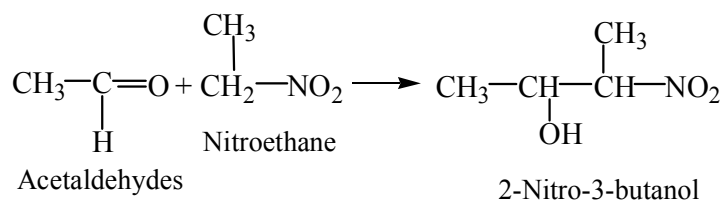

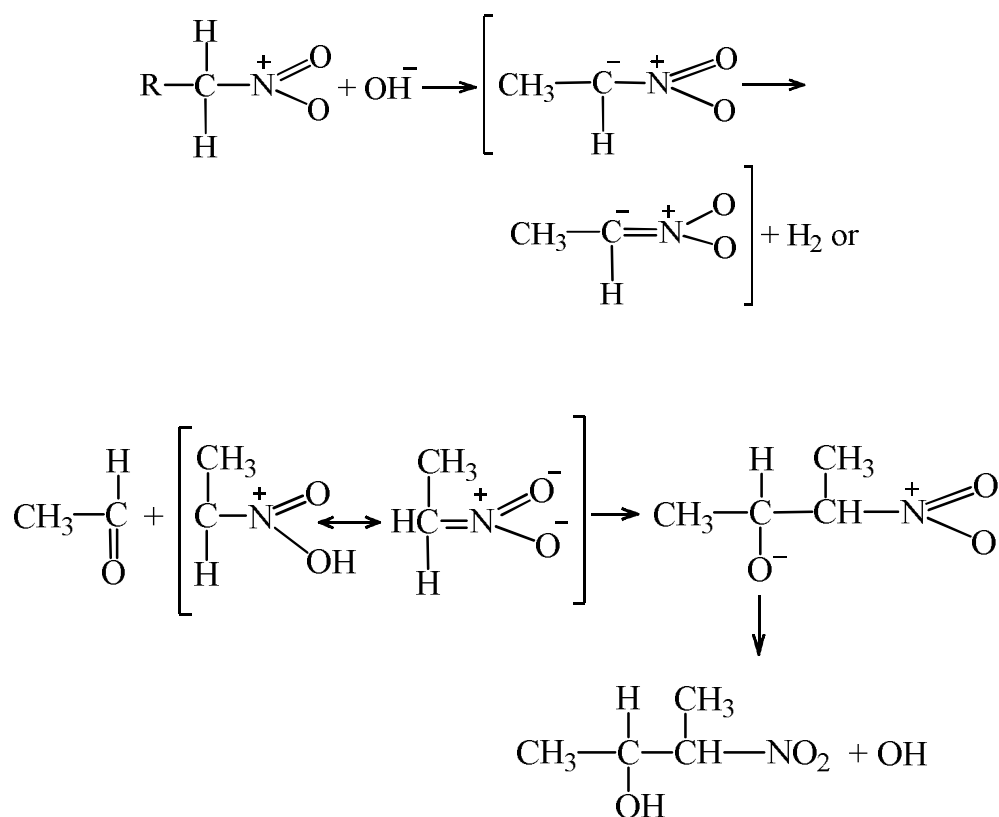

Mannich reaction: Nitro compounds having α -hydrogen atom condense with formaldehyde and ammonia as follows:

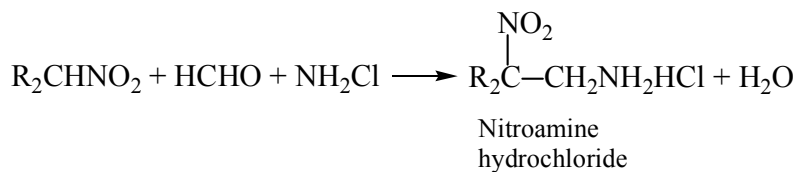

6.6 Methods of Preparation of Aromatic Nitro Compounds

Aromatic nitro compounds are prepared by the Nitration of benzene on its derivatives.

Following nitrating agents are generally employed.

- i. In the case of aromatic compound containing electron releasing agents such as $-\text{NO}_2$ -OH and $-\text{CH}_3$ the reaction takes place with concentrated HNO_3 as the nitrating agents. In some cases even dilute HNO_3 can carry out nitration at room temperature.

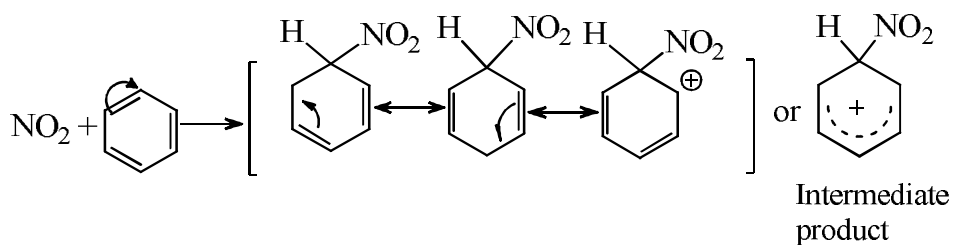

(iii) **Proper transfer to yield in the final product**

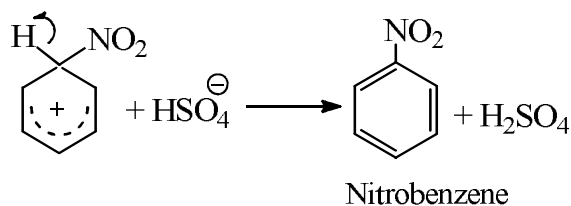

6.7 Physical Properties of Aromatic Nitro Compound

- Physical state:** Nitrobenzene is a yellow acid liquid. Other compounds are yellow crystalline solids. Nitrobenzene has the odour of bitter almonds. It is also known as oil of mirbane.
- Solubility:** Aromatic nitro compounds are insoluble in water but readily soluble in organic solvents such as alcohol and other.
- Melting and boiling points: M.P. and B.P. in** Nitrobenzenes gradually increase as the number of nitro groups increases. This is evident from the table below:

Compounds	M.P. (K)	B.P. (K)
Nitrobenzene	287.7	483.0
m-Dinitrobenzene	363.8	576.0
m-Trinitrobenzene	395.8	-

6.8 Chemical Properties

1. **Electrophilic Substitution:** Nitro group is a deactivation group. So further substitution does not take place easily in the nitro compound. To convert benzene into m-dinitrobenzene fuming HNO_3 is required.

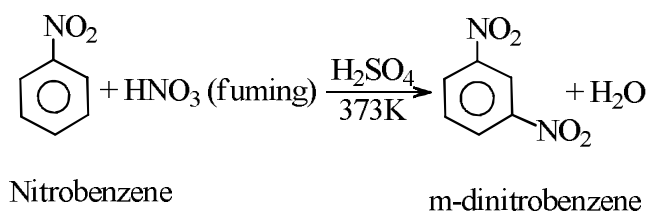

2. **Nucleophilic Substitution:** Nitro compounds easily undergo nucleophilic substitution reaction because of positive charge on the ring as a result of electron withdrawing effect of nitro group.

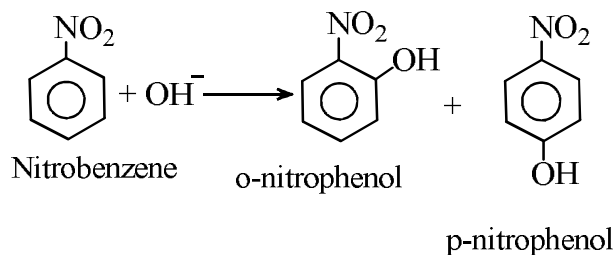

The mechanism of this reaction (taking the case of p-nitro phenol) is as follows:

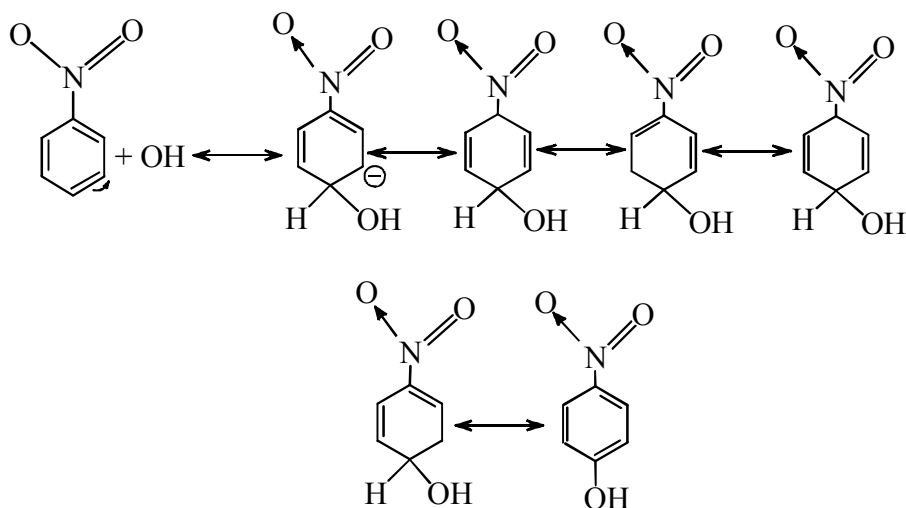

3. **Substitution** of nitro group in poly nitro compounds can be replaced by other nucleophilic groups.

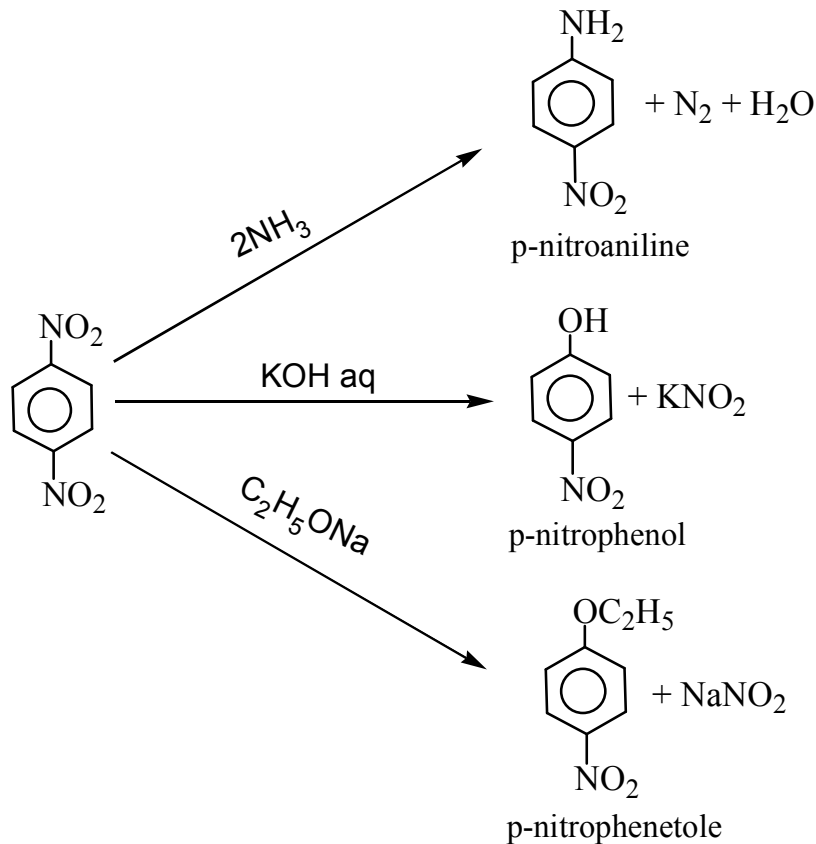

4. **Reduction:** Nitro compounds undergo reduction to give different products with different reducing agent, reaction proceeds in stage involving the following intermediate compound.

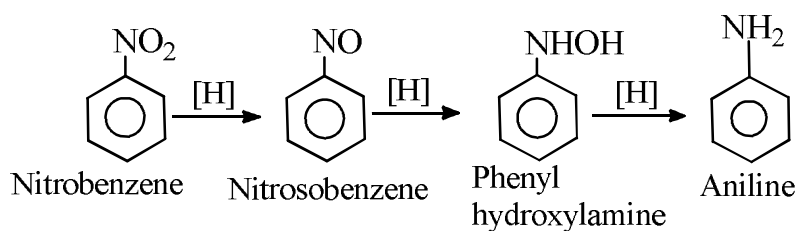

Actual product obtained depends upon the reducing agent used

(i) Reduction in acidic medium

Nitrobenzene on reduction with Zn, Fe or Sn in presence of HCl gives aniline

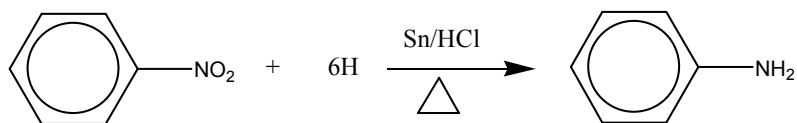

(ii) Reduction in alkaline medium with different reducing agents, different products are obtained

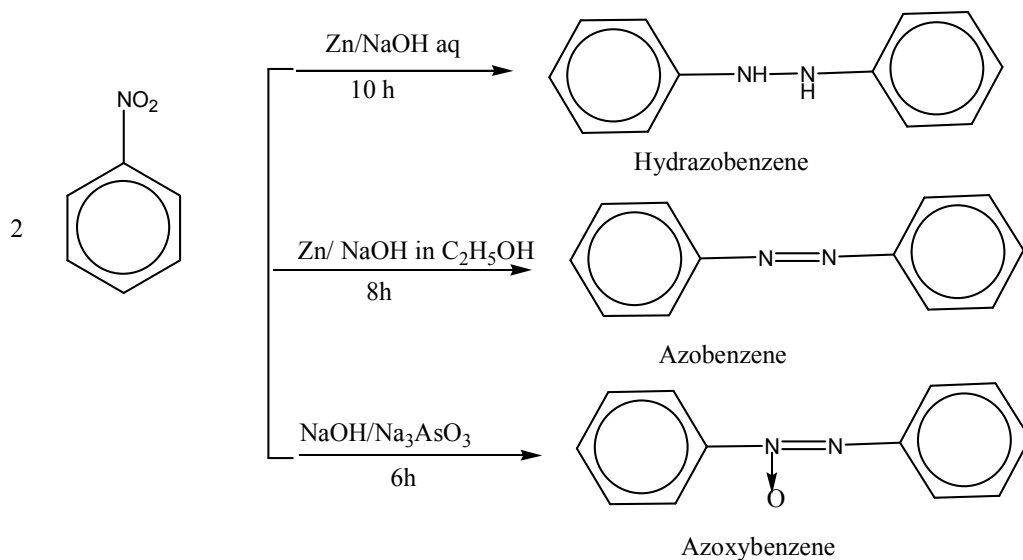

(iii) Reduction in neutral medium on reduction with Zn/NH₄Cl or Zn/H₂O, it produces phenylhydroxylamine.

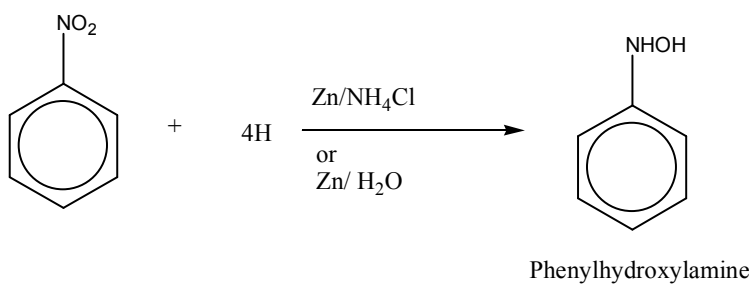

Properties of m-dinitrobenzene

One of the two nitro groups can be selectively reduced to -NH_2 group with the help of NH_4HS of ammonium sulphide or sodium polysulphide.

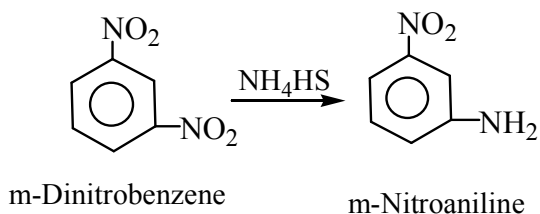

Alkaline $\text{K}_3\text{Fe}(\text{CN})_6$ oxidizes m-dinitrobenzene into 2,4-dinitrophenol.

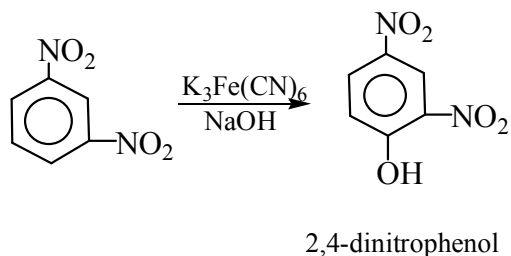

6.9 Halogen Nitro Compounds

Halogen nitro compounds are those aromatic compounds which contain both the halogen and nitro group. Common classes of such compound are derivative of benzene which contain one halogen and one nitro group with different relative position as given below

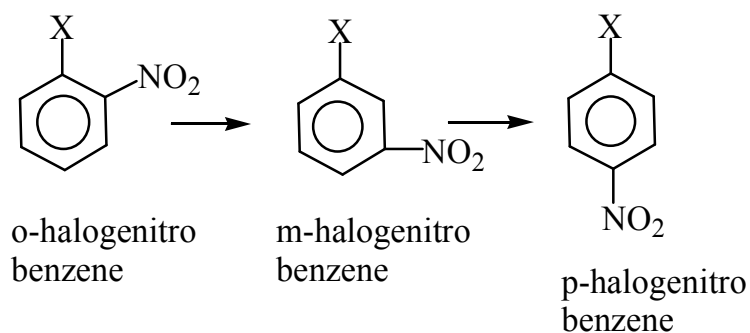

Preparation of o- and p- halogen nitrobenzene

Halogen compounds will be the starting materials. It is subjected to nitration with mixture of nitric and sulfuric acid as the Halogen group is **o- and p-** directing group point we obtain a mixture of o- and p- halogen nitrobenzene. The mixture can be subjected to fractional distillation to separate them into pure substance.

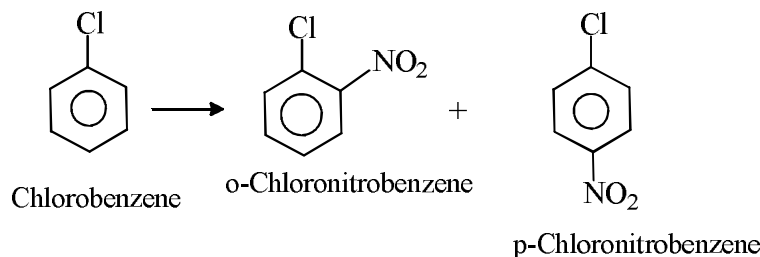

Preparation of M-Halogen Nitrobenzene

Nucleophilic substitution reaction of halogen nitrobenzene is easy. Thus the halogen groups is easily replaced by $-OH$, $-NH_2$, OR groups is ortho or para position easily

It is the nucleophilic substitution. We can compare in the case substitution of chloro group in 4-chloro nitrobenzene 4-nitrochlorobenzene and 2,4,6-trinitrochlorobenzene. In the first case substitution reaction take place with 15% NaCl solution. In the second case with a much weaker base, sodium carbonate and in the third case warming in water is enough to perform the reaction.

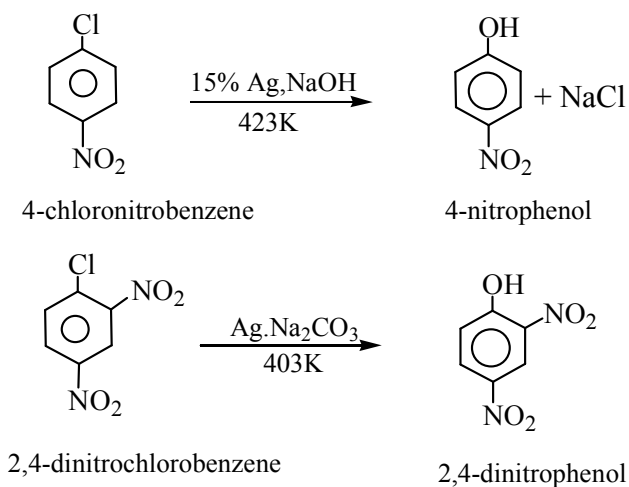

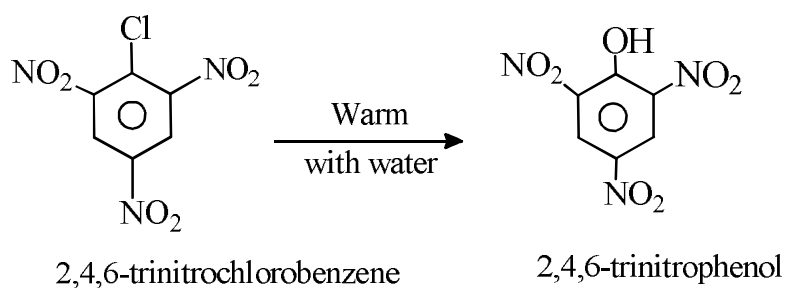

Influence of nitro groups on the reactivity of halogen towards nucleophilic substitution.

Compare the reactivity of two compounds visualising chlorobenzene and o-nitro chlorobenzene towards nucleophilic substitution reaction.

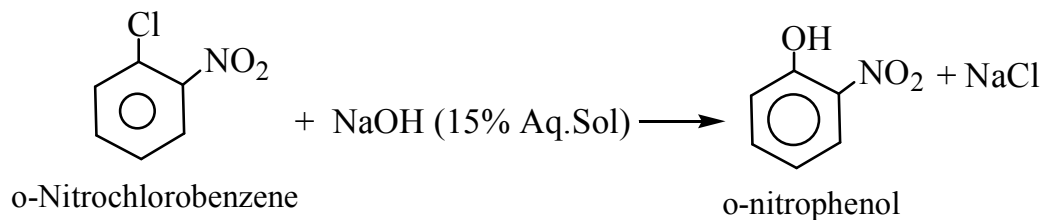
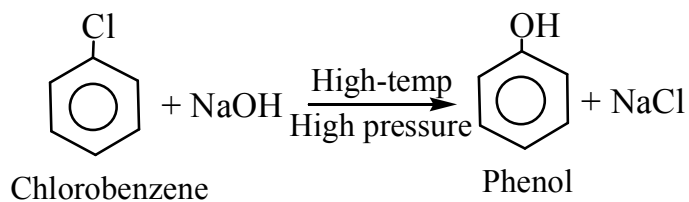

We find that in the sorrel case, much easiest condition are required to perform the reaction in the nucleophilic substitution reaction the following steps are involve

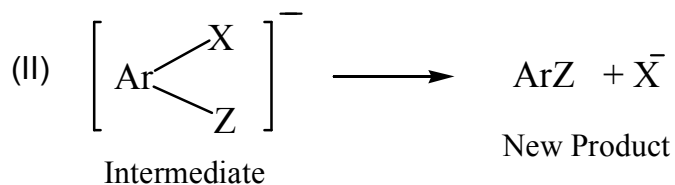
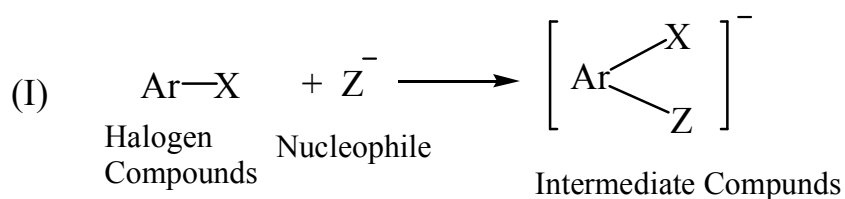

Thus for the reaction to take place efficiently the intermediate compound, a carbonium ion resonance stabilized in the presence of nitro group, (present in ortho or para position) with respect to halogen group. This is shown below.

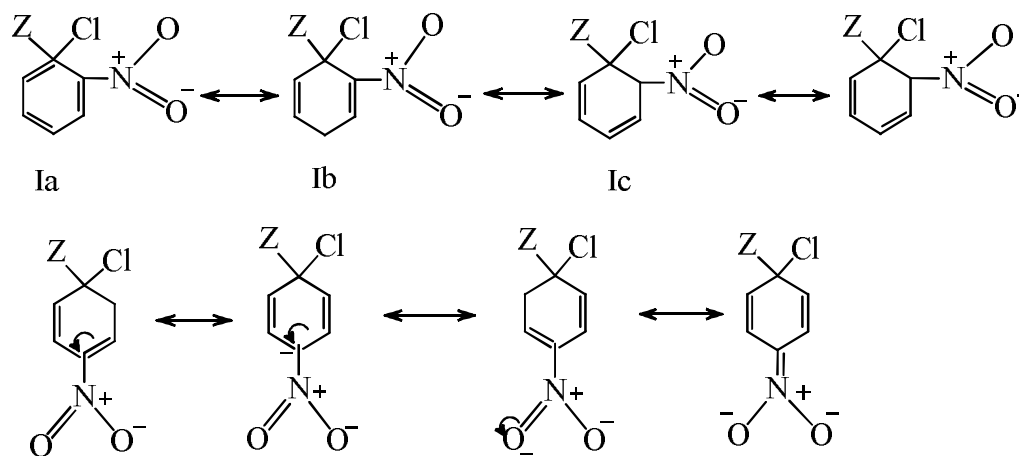

IIa

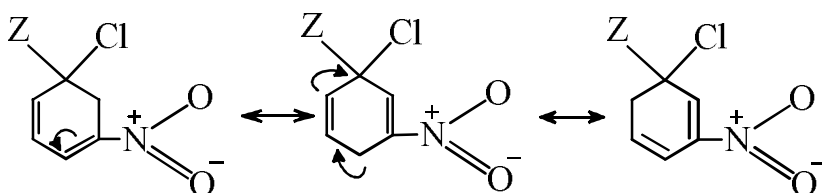

It may be noted that in case of ortho or para nitro chloro benzene the intermediate product has four resonating structure. I_a, I_b, I_c and I_d (for ortho) Whereas there are only three resonating structure in case of meta II_a, II_b and II_c. Hence intermediate compound is one more in case of ortho and para, nitrobenzene compound to negative charge of alternative the positive charge on nitro group substitution of the chloro groups.

6.10 o-, m-, p- Nitroaniline

These are prepared by nitration of aniline but before nitration, it is necessary to protect the -NH₂ group by acetylation

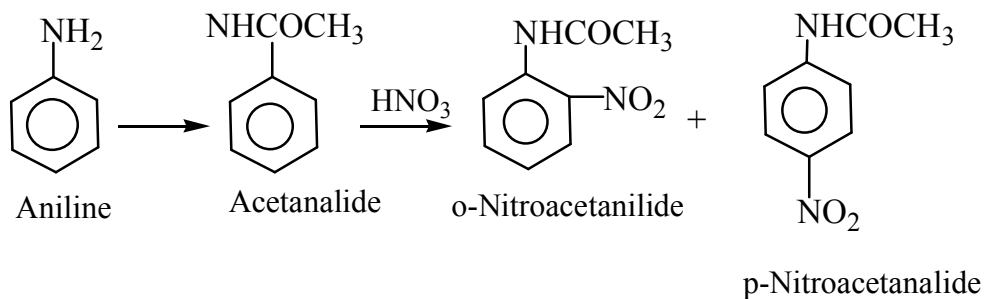

o- and p- nitroacetanilide are separated from each other by shaking with CHCl₃. The ortho derivative is soluble in chloroform whereas para isomer is insoluble. The two are then separately hydrolyzed to get pure o-nitroaniline and p-nitroaniline.

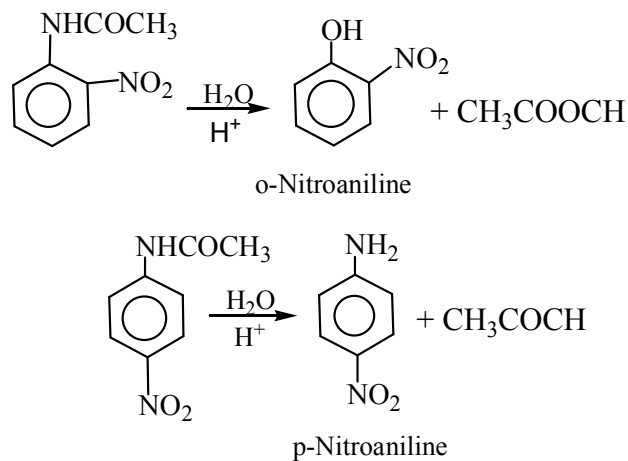

o- and p- nitroaniline can also be prepared by the aminolysis of chloro nitro benzene.

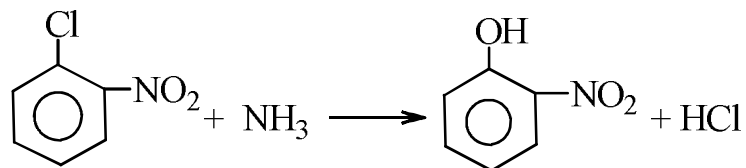

Properties of m-nitroaniline

m-nitro aniline can be prepared by selective reduction of m-dinitrobenzene with ammonium hydrosulphide

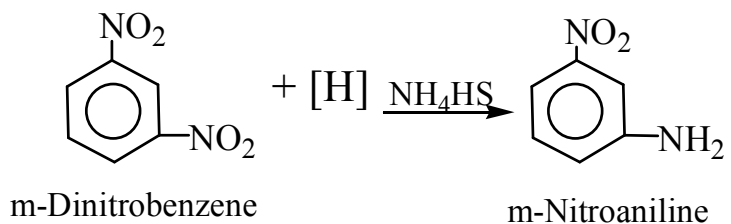

Properties of Nitroaniline

(i) o-, m- and p- on reduction with metal and acid converts into the corresponding phenylenes diamines.

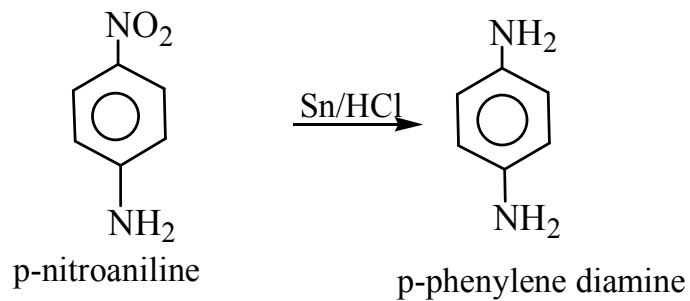
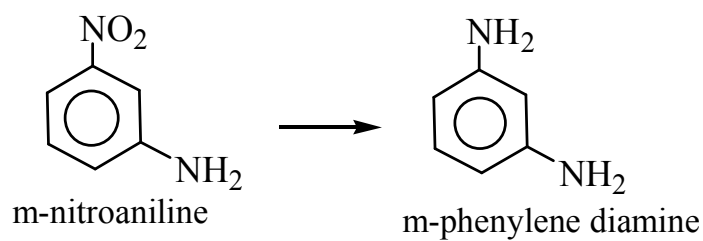
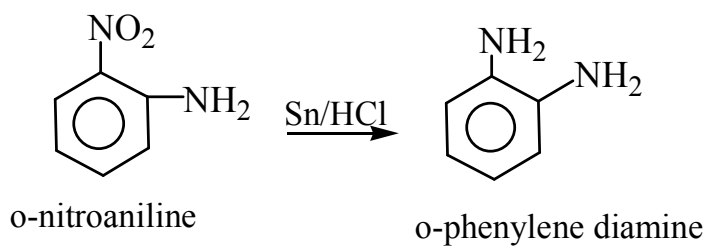

On boiling with sodium hydroxide solution, o and p nitroaniline change into corresponding nitrophenol.

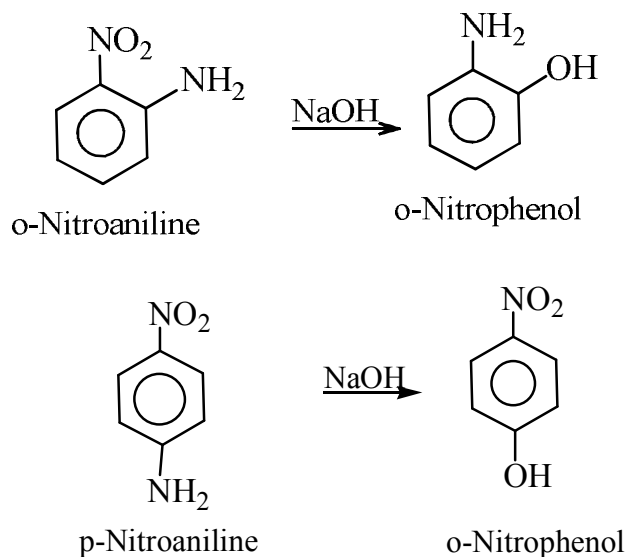

Method of Preparation of o-and p- Nitrophenols

- (i) **Nitration of phenols:** Phenolic group is o-, p- directing group hence it will direct the nitro group in -o and -p position on Nitration of phenols

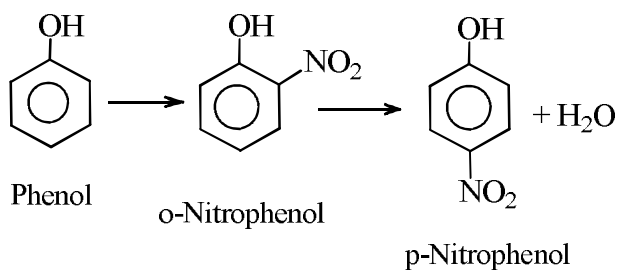

- (ii) **By hydrolysis of o- and p- chloronitrobenzene**

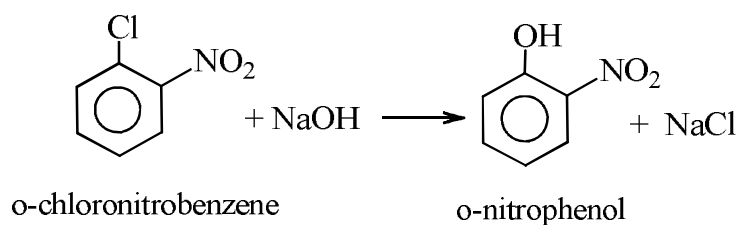

Preparation of m- Nitrophenol

It is prepared from m-dinitrobenzene as follows

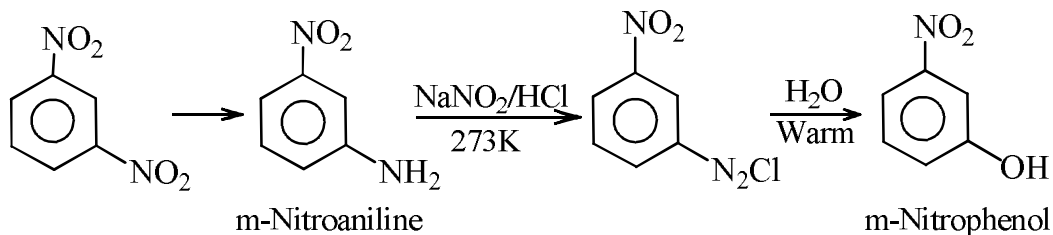

Properties of Nitrophenols

1. The nitrophenols behaves differently as regard solubility in water out of the three isomer of nitrophenol is ortho least soluble in water. It can however be steam distilled out. Among three isomer ortho has the lowest melting point followed by meta and para isomer. In ortho isomer the nitro and phenolic group are so close to each other that hydrogen bond is formed between them as shown below.

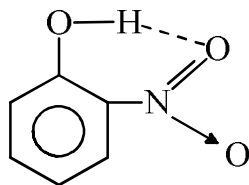

The chances of hydrogen bond between the molecules of o- nitrophenol and water and hence account for its solubility in water. The ortho isomer form intermolecular hydrogen bond with water as shown below and are water soluble.

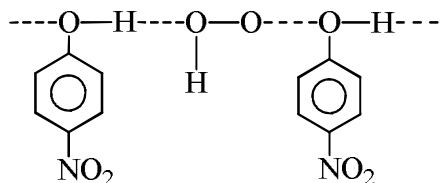

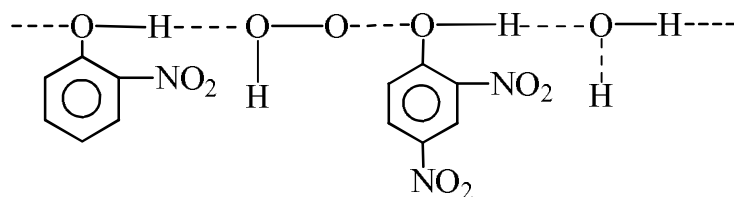

Intermolecular hydrogen bonding also accounts for lowest melting point for ortho nitro phenol, as compared to m- and p- isomers.

- Nitrophenol are acidic compound and acidity enhance due to electron withdrawing -NO₂ group, in turn react below with sodium carbonate to give salt.

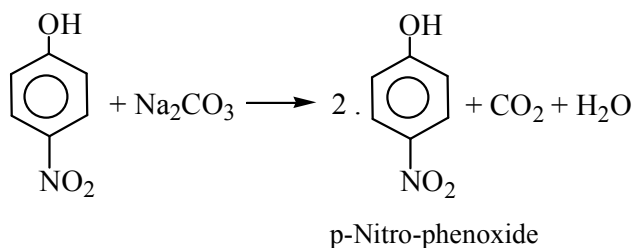

Effect of Nitro Group on the Reactivity of Phenolic Group

Nitro group is an electron withdrawing group hence it helps in the release of protons; the phenoxide ion gets resonance stabilized by the group. This is the reason why nitrophenols are more acidic than phenol.

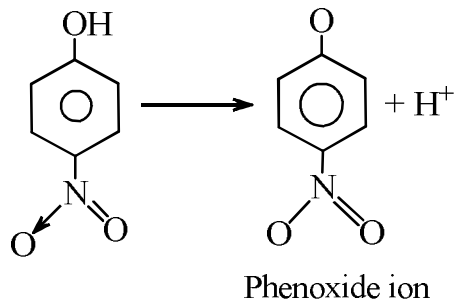

6.11 2,4,6 Trinitrophenol (Picric Acid)

Method of Preparation

From Chlorobenzene

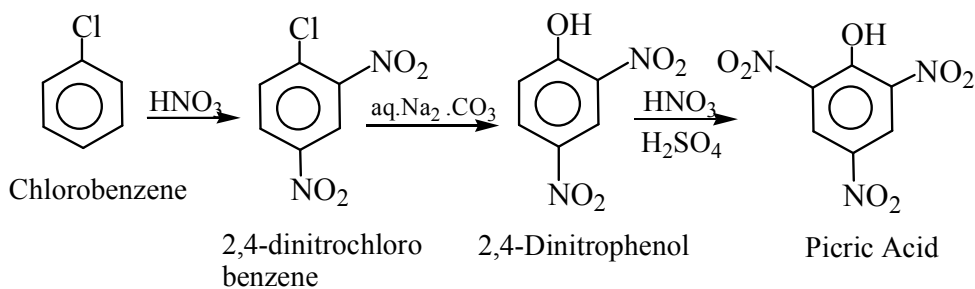

From Phenol

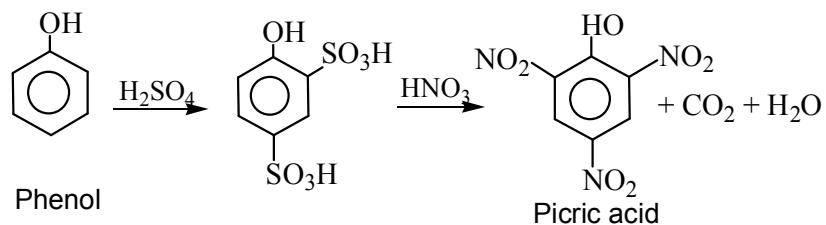

Properties

1. Due to the presence of two O_2 groups it is much stronger acid than phenol it can be decomposed by carbonates a property normally given by Carboxylic compounds and not phenolic compounds.

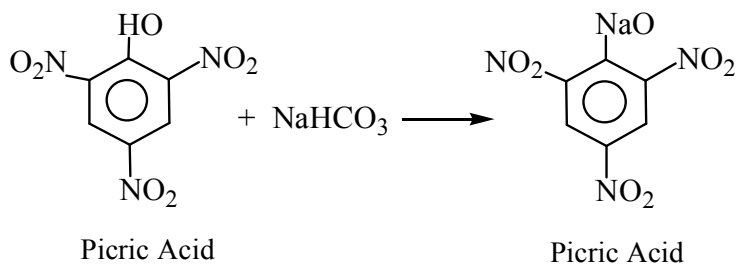

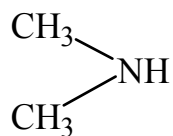

Dimethylamine

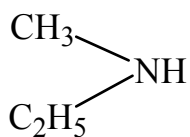

Methylethylamine

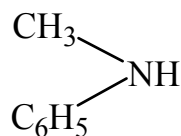

Methylphenylamine

Tertiary amines these are the compounds in which all the three hydrogen atoms are replaced by two or same by three alkyl or aryl groups. Which may be same or different.

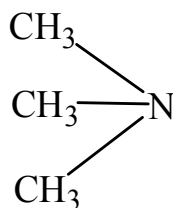

Trimethylamine

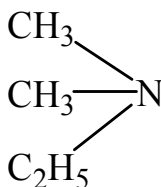

Ethyl dimethyl
amine

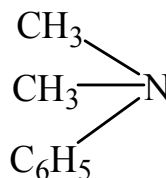

Dimethyl
phenyl amine

There is another classification of amines too.

Alkyl Amine: the amine which contain only alkyl group.

Aryl Amines: amines containing aryl group are known as aryl amines.

Alkyl Aryl Amine: amines containing both alkyl and aryl group in the molecule are known as alkyl aryl amine

Secondary and tertiary amines are classified as under:

Simple amines: Amines containing same are alkyl group attached to nitrogen are called simple amines.

6.13 Nomenclature of Amine

Compound	Common Name	Name IUPAC
Primary amine		
$\text{CH}_3\text{-NH}_2$	MethylAmine	Aminomethane
$\text{CH}_3\text{-CH}_2\text{-NH}_2$	EthylAmine	Aminoethane
$\text{CH}_3\text{-CH}_2\text{-CH}_2\text{-NH}_2$	Propylamine	Aminopropane
$\text{CH}_3\text{-CH}(\text{CH}_3)\text{-NH}_2$	IsopropylAmine	Propane-2-amine

Aromatic amines

Simplest aromatic amine is aminobenzene or aniline.

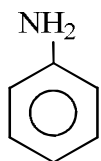

Aminobenzene or aniline

IUPAC name of aniline is Benzene Amine

There are amines in which other position in the benzene ring are occupied by other groups, their position, relative to -NH_2 group attached, then the number increase as we move clockwise.

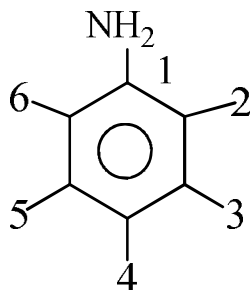

By another convention the position next to the amino group is ortho with gap of one position, meta and that vertically opposite to NH_2 group is para .

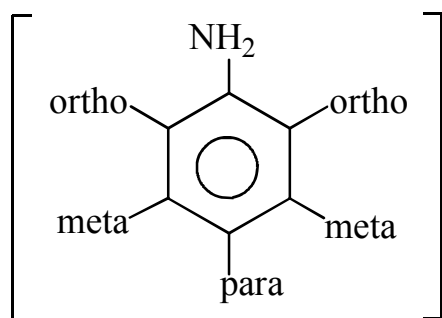

The compounds are named according to three positions, there are special name also.

6.14 Structure and shape of amine molecules

As amines are derivative of ammonia the shape of the former is basically the same as that of the later. We know that ammonia uses sp^3 hybridization but for the four, three hybridized orbitals oriented towards the corner of a tetrahedron. The fourth orbital contains a lone pair of electron and the shape of NH_3 could be represented as follows.

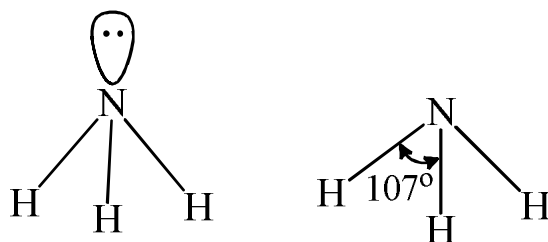

As amines molecules are obtained by replacing hydrogen by alkyl or aryl groups their shape could be represented as:

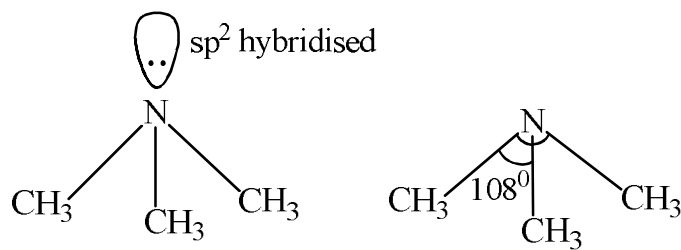

As the angle \angle HNH video in ammonia is known to be 107° degrees we expect an equal angle in case of amines also. It has been observed that trimethyl amine has an angle CNC equal to 180° .

6.15 Method of Preparation of Amines

Common methods for preparing primary secondary and tertiary amines.

1. Amonolysis (Hoffman's Method):

This reaction involves treating an alkyl halide or an aryl halide of the type $C_6H_5CH_2X$ with alcoholic ammonia solution to give primary amine. If the alkyl halide is in excess, secondary and tertiary amines are formed, finally tertiary amine attach itself to the alkyl halide molecules to form quaternary ammonium salt these reaction are explain as under.

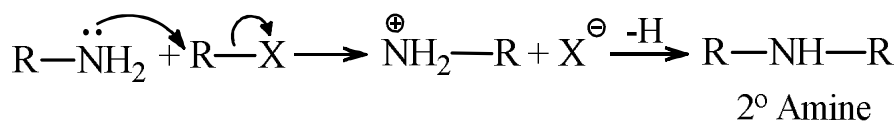
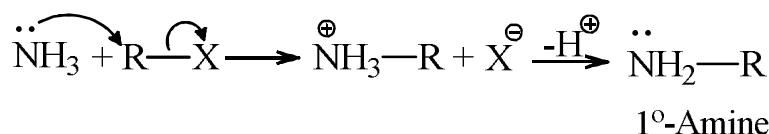

For example

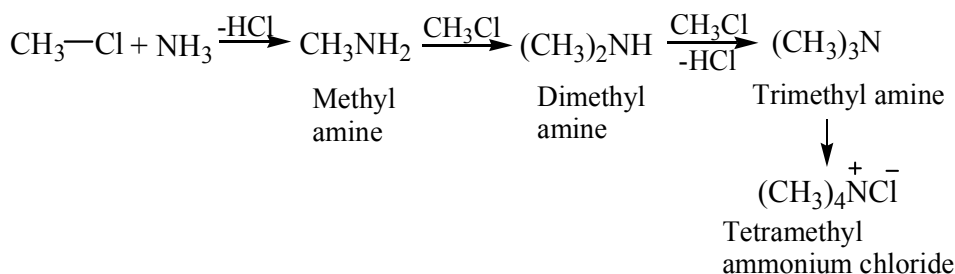

We generally obtain a mixture of the above substance on the amonolysis of methyl chloride. However reaction can be made in two steps i.e. at the step of primary amine, again by taking large excess of NH_3 so that alkyl halide is available to the primary amine

once it is formed, for preparing secondary and tertiary amines. For preparation of aryl halides are treated with ammonia but drastic conditions are used.

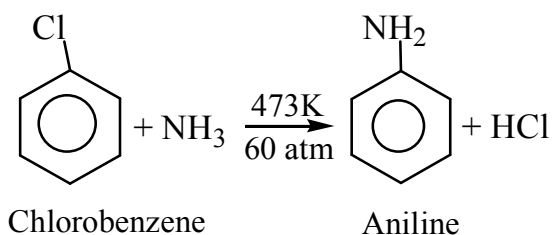

But it is easier to ammonialise aromatic compounds with a side chain.

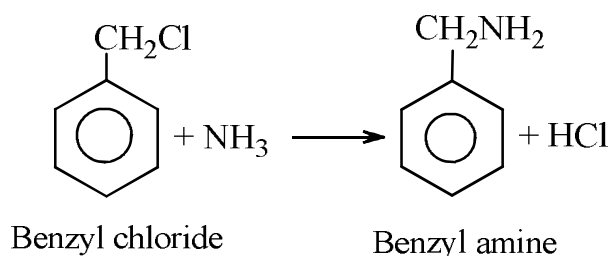

2. By the action of ammonia on alcohols or phenols:

On passing a mixture of alcohol and ammonia over heated alumina 633 K, a mixture of primary, secondary and tertiary amine is obtained.

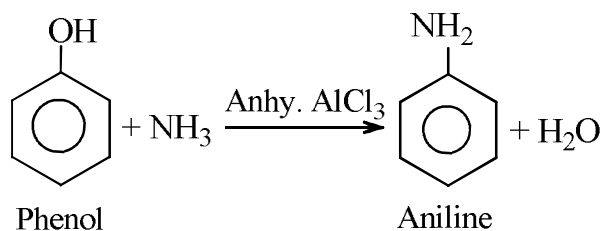
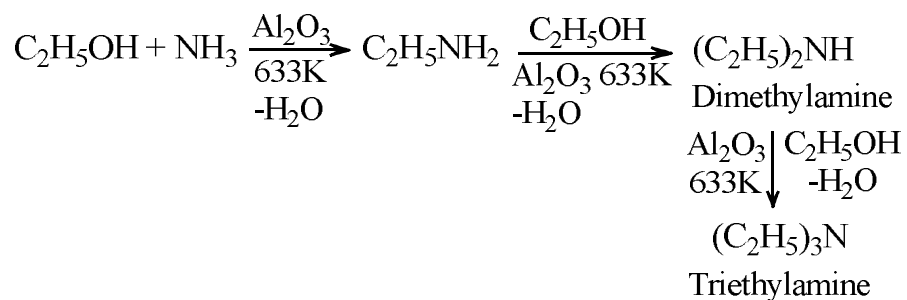

3. Reductive amination of aldehyde and ketone:

Aldehyde and Ketone on reduction with hydrogen and Ammonia change into 1^o amine at 373K and 150 atmospheric pressure and in the presence of Ni catalyst.

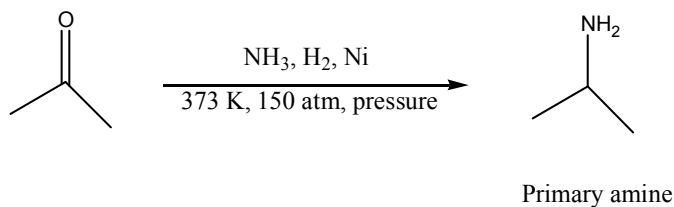

4. Reduention of nitro compounds:

Nitro compound on Reduction for hydrogenation give rise to amine

- i. **Catalytic hydrogenation:** Nitro compound is treated with H₂ gas in the presence of finely divided Ni or Pt.

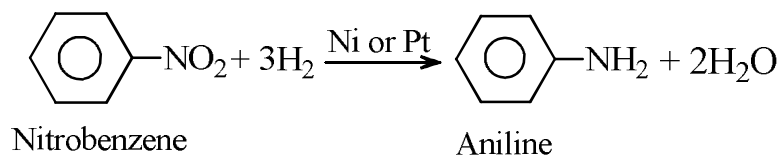

- ii. **Reduction** -Here the nitro compound is dissolved in HCL and treated with tin metal.

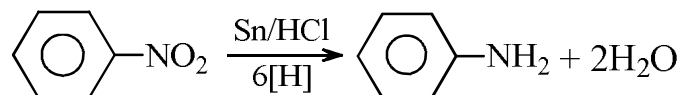

- iii. **Partial reduction** One of the two nitro groups in a nitro compound can be reduced keeping the second intact using ammonium hydrogen sulphide as the reducing agent.

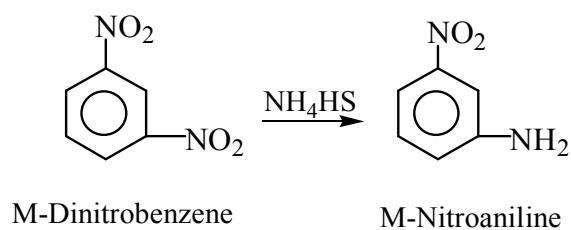

5. **Mendius Reaction:** aliphatic and aromatic nitro compound can be reduced by catalytic hydrogenation or chemical reduction to produce amines point when the reducing agent is Sodium and alcohol, the reduction is known as Mendius reaction or reduction.

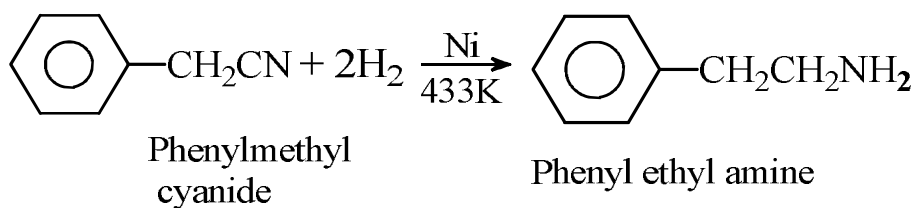
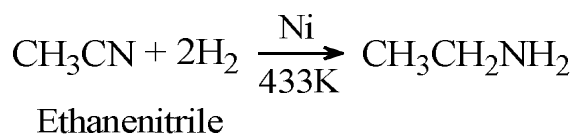
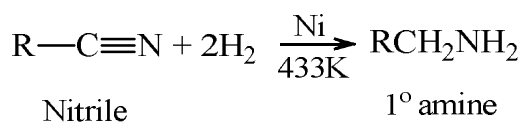

6. **Gabriel Synthesis:** Phthalimide is converted into potassium salt on treatment with KOH potassium phthalimide on treatment with an alkyl or aryl halide forms and N-substituted phthalimide which is hydrolyzed to produce phthalic acid and primary amine point hydrolysis is performed with 20% HCl under pressure

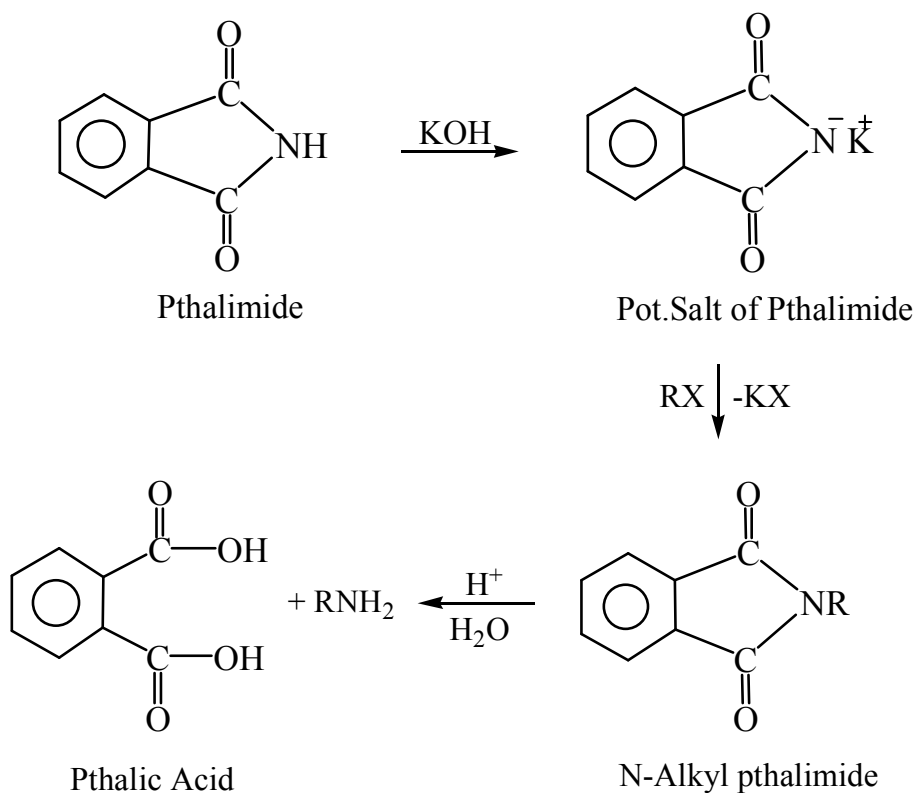

7. **From Grignard Reagent:** Grignard reagent react with chloramine in ether to produce amine.

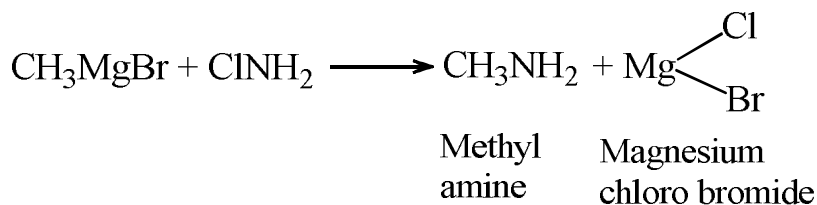

6.16 Distinction between Primary, Secondary and Tertiary Amines

Different methods to distinguish between different amines are discussed as under.

1. Nitrous acid method:

Aliphatic primary amines react with HNO_2 to give an effervescence of Nitrogen gas.

Secondary amines react with HNO_2 to form diazonium salt.

Tertiary aromatic amines react with nitrous acid to give green colour p-nitroamine.

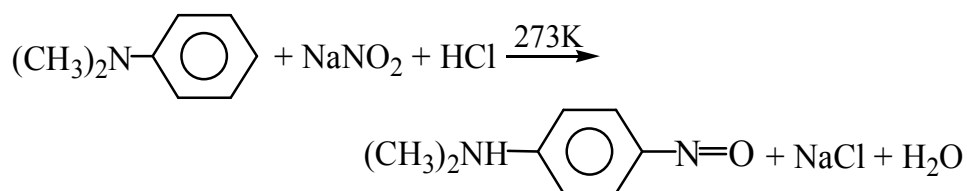

P-nitroso N,N-dimethyl aniline

Aliphatic amines react with HNO_2 to form water soluble amine salt trialkyl

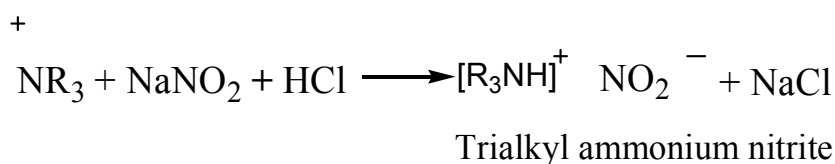

2. **Heisenberg method:** It is a very reliable test for distinguishing between amines and consists of following steps.

Amine is shaken with benzene sulphonyl chloride in the presence of alkali -

A primary amine will form a soluble sulphonamide salt, which on acidification gives primary amine. A secondary amine in the same reaction will form an insoluble sulphonamide. Tertiary amines do not form stable sulphonamides.

If the unreacted amines remain soluble in alkali but dissolves on acidification, it indicates tertiary amines.

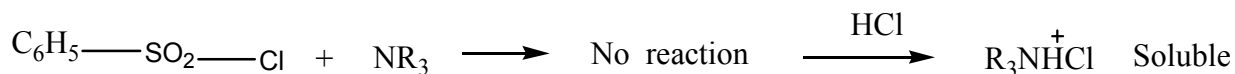
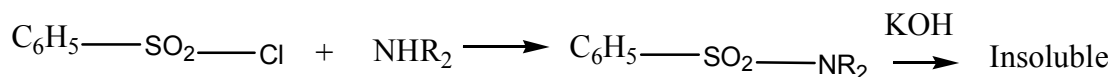
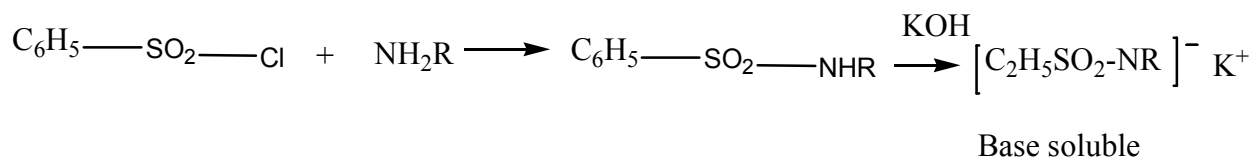

3. **Carbylamine Test:** This test can be used to distinguish primary amines from secondary and tertiary amines. The amine is heated with chloroform and alcoholic potassium hydroxide if a strong offensive odour is noticed it is primary amine

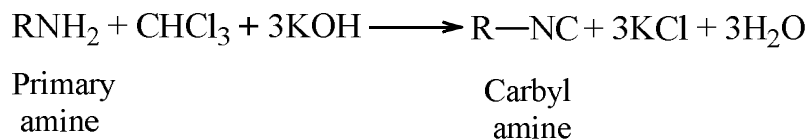

6.17 Basicity of Amines

An aqueous solution of amine exists in the following equilibrium state.

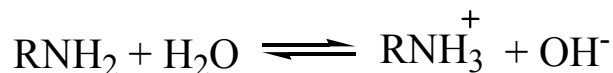

For a reaction in equilibrium we have the following sentence:

$$K_b = \frac{[\text{RNH}_3^+][\text{OH}^-]}{[\text{RNH}_2]}$$

K_b it affects the existence of basic character of a base. pK_b this is another term which is called to express the basic strength of a base it is related to K_b as follows

$$pK_b = -\log k_b$$

That it is negative logarithm of the basicity constant K_b it will be asserted that higher the K_b value, lower is the pK_b value. For example for methyl amine the value of K_b and pK_b are as follows

$$K_b = 4.4 \times 10^{-4}$$

$$pK_b = 3.6$$

So for two bases X and Y if x has a higher value of K_b it will have a lower value of K_b , pK_b values of a few important amines are given in the table below

6.18 Explanation of Relative Basicity

According to modern acid base theory the basicity of amine depends upon the availability of electron pair on nitrogen atom and the stability of the substituted ammonium ions formed. Any factor that has the opposite effect will decrease the basicity. Different cases are considered as under.

A. Aliphatic amines aliphatic amines have greater basicity as compared to ammonia test can be explained in terms of inductive effect given below as-

1. **Inductive effect** the greater basicity of aliphatic amines as compared to ammonia can be explained in terms of the electron releasing inductive effect of alkyl group. Aliphatic amines contain one or more alkyl groups in place of hydrogen atom of ammonia and alkyl group in electron releasing, increases the electron density on nitrogen and thus makes the electron pair on nitrogen more available for sharing. The electron releasing in the effect of alkyl group the amine and thus increases its stability.

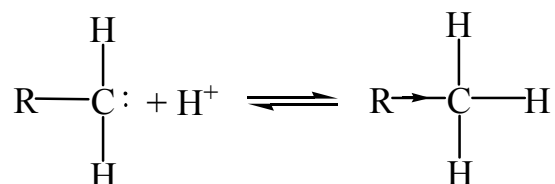

It may be noted in term of inductive effect alone, a tertiary amine should be more basic than a secondary amine which in turn should be more basic than a primary amine while it is true that secondary amines are stronger bases than primary amine the tertiary amine have been found to be weaker than secondary amines and sometime even weaker than primary amine as shown below

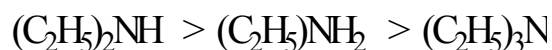

2. Solvation effect this factor strongly influence the basicity of amines in aqueous solution the substituted ammonium ions formed by amines by taking up a Proton gets highly soluble in water. But the existence of Solvation and consequently can form hydrogen bond as shown below.

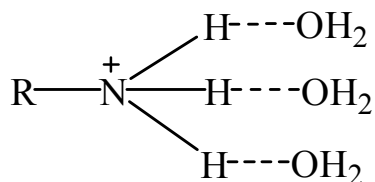

Substituted ammonium ion from primary maximum stabilization by solvation.

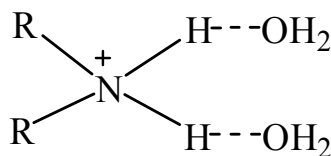

Substituted ammonium ion from secondary maximum stabilization by solvation.

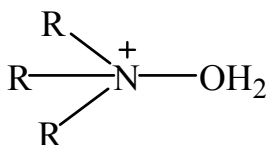

Substituted ammonium ion from tertiary maximum stabilization by solvation.

As such the basicity of the amines should increase corresponding in the order



Therefore the basicity of amine will depend upon the combined effect of inductive effect and solvation effect.

The least stabilization of Ammonium Ion obtained from 3 degree amine is responsible for lower basicity of such amine than expected on the basis of inductive effect alone.

The fact that methylamine is a stronger base than ethyl amine (1^0) while tri methyl amine is weaker basic methylamine (1^0) can be explained as follows-

ethyl group has a greater electron releasing effect than methyl group therefore in methyl amine +1 effect of three ethyl group in triethylamine 3^0 is a stronger base than ethyl amine (1^0). But in case of trimethylamine (3^0) and methylamine (1^0), the solvation effect dominates over the three methyl group in trimethylamine therefore methyl amine (1^0) is stronger base than trimethylamine (3^0)

It is interesting to make gas phase the basicity of methylamine follow the order



This is obviously due to the fact that no solvation effect is involved where only the inductive effect plays its part

B. Aromatic Amines are weaker as compared to ammonia and aliphatic amines. Consider the contributing structure of aniline and anicylium ion shown below

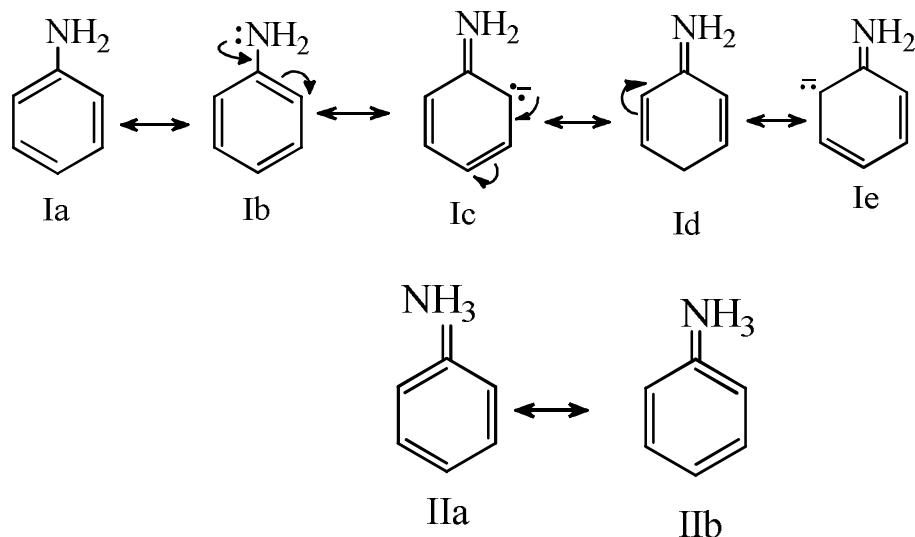

We find that aniline is a resonance hybrid of 5 contributing (Ia to Ie) forms as a result in the resonance hybrid structure of aniline the electron pair on nitrogen is less available for sharing with proton.

Mixed Aliphatic Aromatic Secondary Amines:

These are slightly stronger bases than purely aromatic amine this is because of presence one of more electron releasing alkyl group in mixed amines has the electron pair on nitrogen atom is relatively more available for sharing, then the electron pair on nitrogen of purely aromatic amines

6.19 Effect of Substitutions on the Basicity of Aromatic Amines

Aniline has the pK_b value of 9.387 if some group is introduced in the benzene ring of aniline molecule, we find that there is appreciable change in the pK_b and the value of the same substituted in anilines are given in the table 8.2

Table 8.2 pK_b values of ring substituted anilines.

(pK_b of aniline = 9.387)

Substituent	pK_b		
	Para isomer	Meta isomer	Ortho isomer
-CH ₃	8.93	9.31	9.6
-OCH ₃	8.83	9.7	9.53
-NH ₂	7.83	9.13	9.5
-Cl	9.82	10.53	11.31
-NO ₂	13	11.53	13.46

Some Important Observation Some Important Observation: Some important observation Some important observation related to the nature and positions of the substituent on the basicity are made as under.

- Electron releasing groups exert greater base strengthening effect when present in para position than when present in meta position

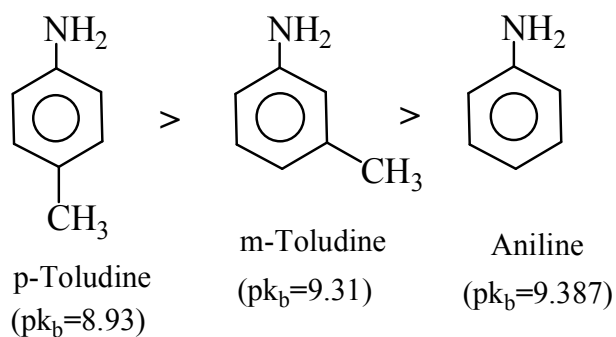

- ii. Electron withdrawing group usually exert greater base weakening effect when present in para position than in meta position.

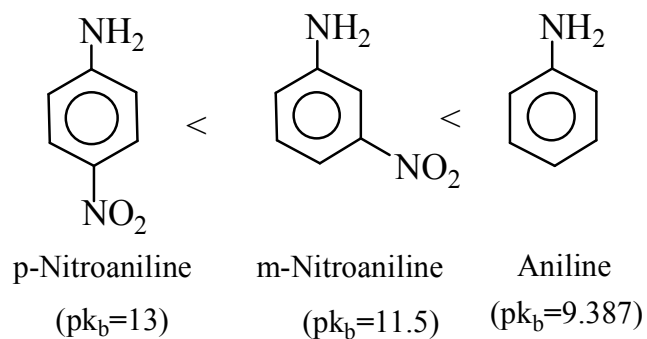

- iii. Group like -OCH₃ and -OH behave in a peculiar manner they act as a base strengthening when present in para but have weakening when present in meta position as shown by the p*K*_b values of the following of the components.

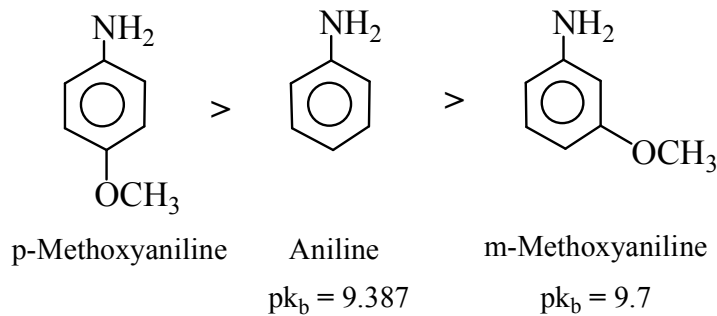

Ortho effect

Even the electron releasing group decrease the basic strength when present in ortho position the phenomenon of decreasing basic strength with electron releasing as well as electron withdrawing group in the ortho position is known as ortho affect.

Example: Explain why aniline is less basis than cyclohexylamine?

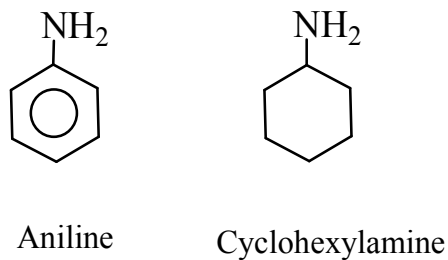

Smaller basicity of aniline is due to delocalization of non bonding electrons on the amino group is aniline.

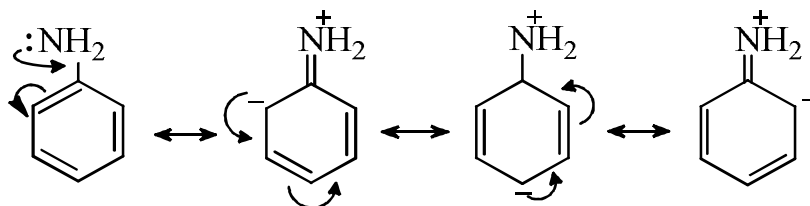

No such delocalization of electron takes place in cyclohexyl amine

6.20 Exhaustive Methylation of Amines and Hoffman's Elimination

2) A Substituted quaternary ammonium hydroxide on heating gives an alkene. A quaternary ammonium hydroxide is prepared by exhaustive methylation of amine by a series of reaction given below.

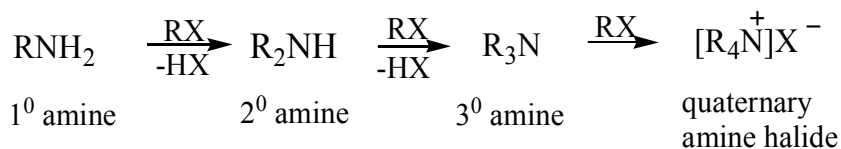

Exhaustive methylation:

These solution of quaternary ammonium halide is obtained above is treated with moist Silver oxide.

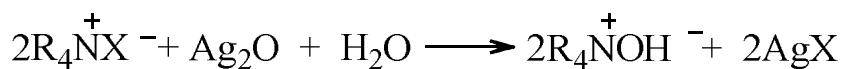

Quaternary hydroxide

Quaternary Ammonium hydroxide on heating strongly at 400k undergo and elimination reaction as under given below:

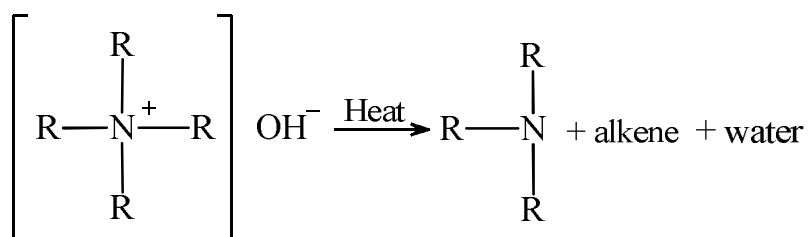

Taking a particular example:

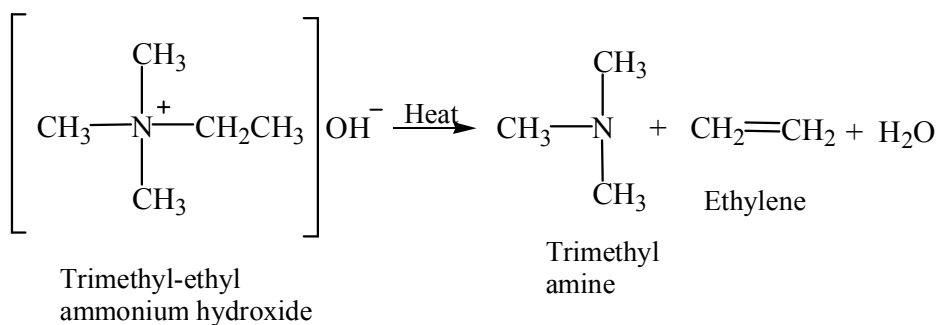

This reaction is known as Hoffman's elimination

6.21 Cope Elimination

Cope elimination is a reaction which is performed to identify the unknown tertiary amine it involves treatment of tertiary amine with hydrogen peroxide to obtain amine oxide which on heating gives and, N,N dialkyl hydroxyl amine and alkene.

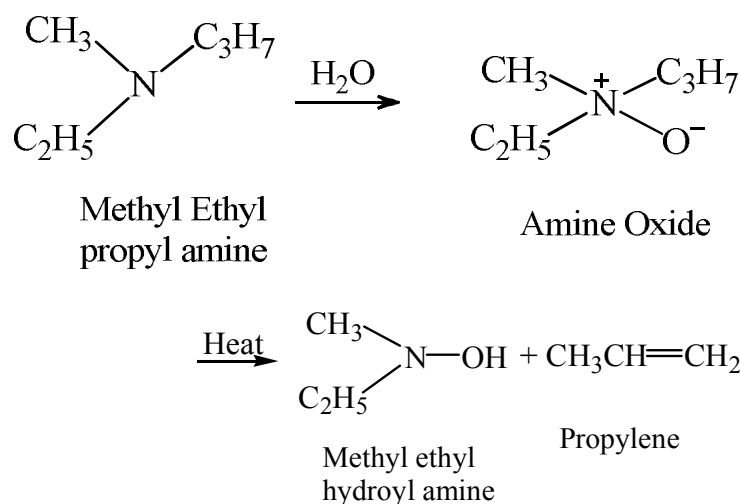

the dialkyl hydroxyl can be again converted into tertiary amine on treatment with CH_3I and Ag_2O , and cope elimination reaction is performed provided there is still beta hydrogen atom in the molecule.

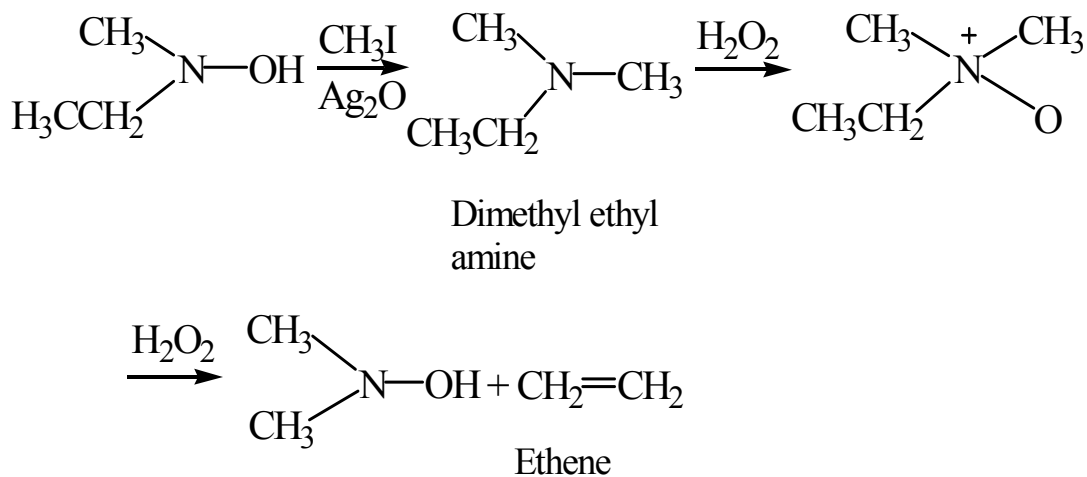

It may be noted in the first cope elimination process propylene was obtained and in the second cope elimination process Ethene was obtained.

6.22 Amine salts as phase transfer catalyst

Transporting a species from a medium in which it is soluble to a medium in which it is ordinary insoluble is called phase transfer which might not possible by conventional method.

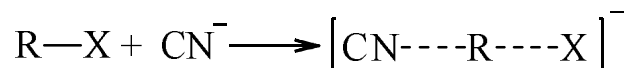

Let us say we want to carry out the substitution reaction of alkyl halide (RX) with CN^- ions we dissolve the alkyl halide in benzene and potassium cyanide in water, we also add a small quantity of the amine salt (Tetra alkyl ammonium halide). We add the benzene solution of alkyl halide to the aqua solution of potassium cyanide containing a little of $\text{R}_4\text{N}^+\text{X}^-$ $\text{R}_3\text{N}^+\text{X}^-$ being solution in both the media will start diffusing into the benzene larger.

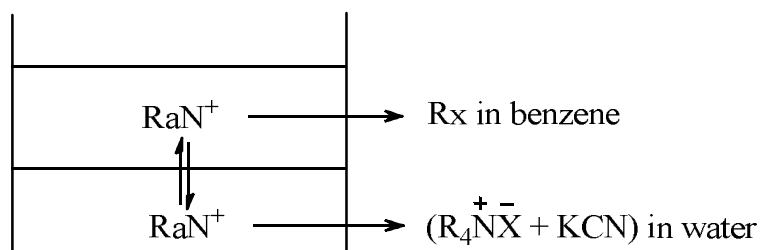



Phase transfer catalysis

Diazonium Salt : Diazonium salt are organic compound containing and N_2X group where X is halogen it could also be $-\text{NO}_2$ $-\text{HSO}_4$ or $-\text{BF}_4$ for halogen group. This compound resemble ammonium salt in some respect.

Nomenclature

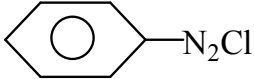
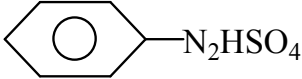
Diazonium Salt are named by adding 'diazonium' to the aromatic compound to which it is attached followed by the name of anion. Names of some diazonium salt are given below.

Compound	Name
	Benzenediazonium chloride
	Benzene diazonium hydrogen Sulphate
	P-Toulene diazonium Bromide
	P-Nitrobenzene diazonium fluoroborate

6.23 Structure of Benzene Diazonium Chloride

- It has molecular formula $C_6H_5N_2Cl$, as confirmed by qualitative and quantitative analysis
- It is a colourless crystalline solid, soluble in water but insoluble in alcohol and ether
- It undergo substitution reaction in which N_2Cl group is replaced by monovalent group like $-Cl$, $-Br$, $-CN$, or $-NO_2$.
- Benzene diazonium chloride exhibit salt like character.
- It gives coupling reaction with phenols and amines to form azo compounds of the type.

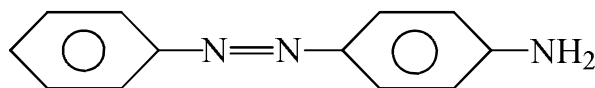

- On reduction with stannous chloride and hydrochloric acid it forms phenylhydrazine.

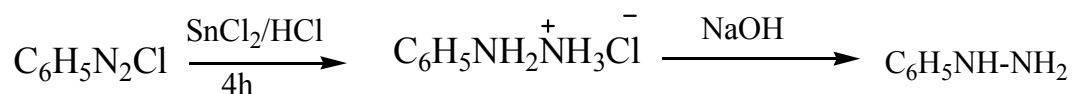

Griess Formula: Griess discovered the benzene diazonium chloride. He proposed a structure for this compound in which two nitrogen atoms were directly attached to consistent with the

properties of the compound. It did not explain the following properties-

- Its salt-like character.
- Replacement of N_2Cl by other monovalent group.
- Reduction to phenylhydrazine in which only one nitrogen is attached to the benzene ring.
- Formation of azo compound by coupling reaction.

Kekule Structure:

Kekule gave its structure of Benzene diazonium chloride as under

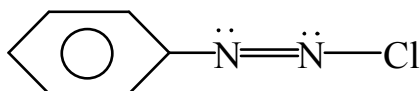

This formula explain satisfactorily replacement of N_2Cl by monovalent group, coupling reaction and reduction to phenylhydrazine but it didn't account for the salt like or ionic nature of the compound.

Blomstrand formula

Blomstrand gave the following structure for benzene diazonium chloride.

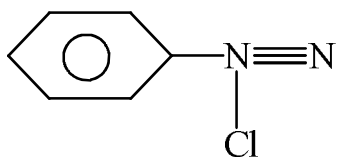

But this has been modified to

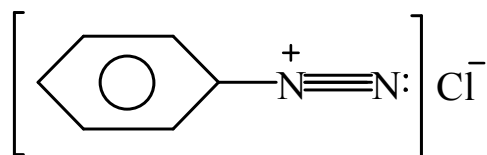

This modified structure resembles that a ammonium chloride, which can be written as:



This structure very well explain the following

- Salt like or ionic structure for the compound as indicated by conductivity measurement
- Solubility in water and insolubility in common organic solvents.
- Existence of geometrical disomer exhibited by diazoates.

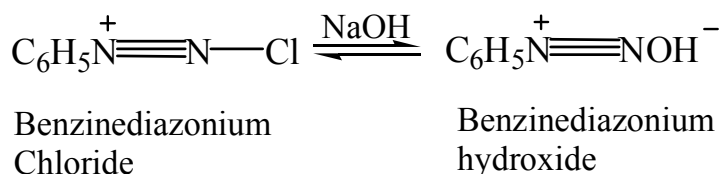

Due to the presence of double bond between N-N and there exist a possibility of occurrence of geometrical isomer as given below.

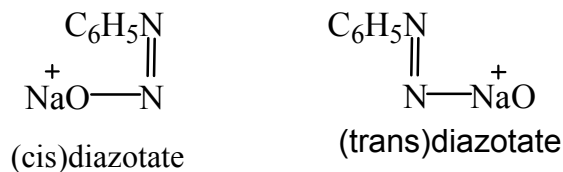

6.24 Laboratory Preparation of Benzenediazonium Chloride

Diazonium salt is prepared by reaction of aromatic primary amine and nitrous acid obtained from sodium nitrite and dilute hydrochloric acid in solution. For preparing benzenediazonium chloride, the following method is adopted and aniline is dissolved in dilute hydrochloric acid and the solution is cooled to 273-278K. Now a cooled solution of sodium nitrite is added to the first solution taking care that the temperature does not rise beyond 278 Kelvin. The addition of sodium nitrate is stopped as soon as a few drops of reaction mixture gives a blue colour with starch-potassium iodide solution. This is completion of diazotization.

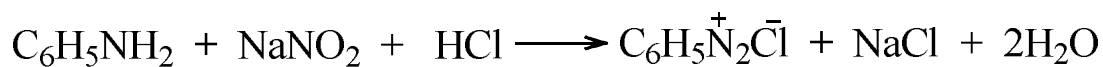

Benzene diazonium chloride obtained above is used as such in the solution it is not extracted or crystallized out, because dry Benzene diazonium chloride is explosive.

Mechanism of Diazotization:

It is believed that the amine molecule undergoes nucleophile reaction by attaching itself to nitrous anhydride obtained from nitrous acid.

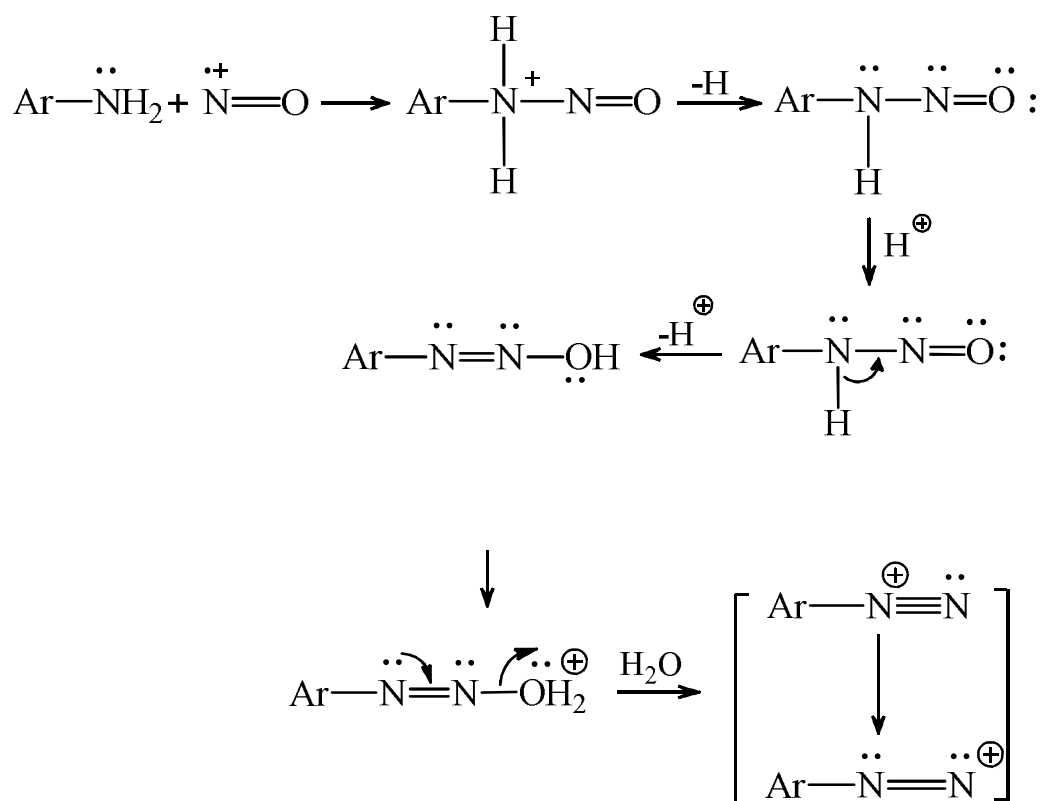
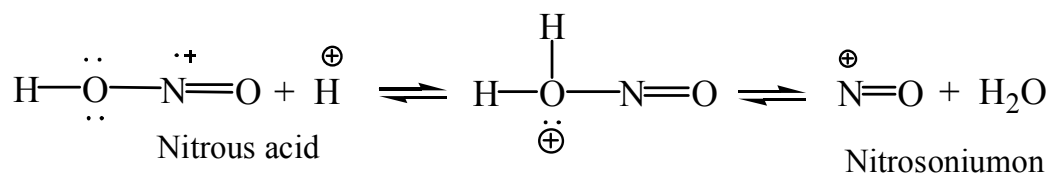

Aromatic amines containing electron withdrawing groups in the benzene ring are difficult to diazotise this is because mechanism it is nucleophilic reaction.

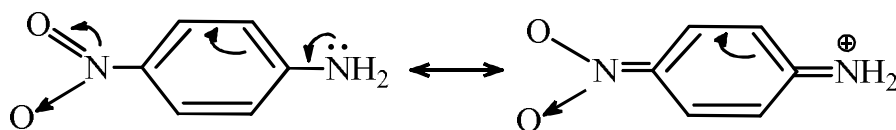

6.31 Chemical Properties of Benzene Diazonium Chloride.

Property of Benzene diazonium chloride can be discussed under two heads.

- A. Reaction in which N_2 evolve and the $-N_2Cl$ group is replaced by some other monovalent group.
- B. Coupling reaction of reduction, in which nitrogen atoms are retained. These reactions are being given separately as under.

Reaction in which N_2Cl is replaced by some other group.

1. **Replacement by -Cl, -Br or -CN:** This is a reaction in which group is replaced by one of above-mentioned groups. The reaction is carried out by treating a substitution of diazonium salt with cuprous chloride bromide or cyanide, the reaction is given as under.

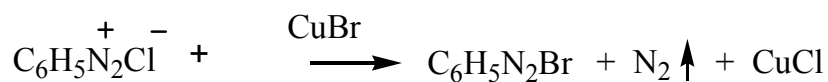

This reaction is known as reaction in steps, the different reaction known as Gattermann reaction where replacement by -Cl, Br or -CN is done by taking copper powder and halogen acid.

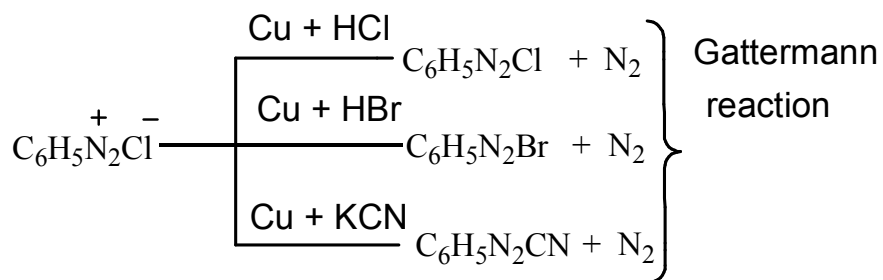

2. **(A) Replacement by Iodine:** On warming diazonium salt solution with potassium iodide solution, N_2Cl group is replaced by iodine group.



(B) Replacement by Fluoride (Baltz-Schiemann reaction):

The diazonium salt when treated with fluoboric acid, the diazonium fluoroborate precipitates. The dry precipitate is heated to get aryl fluoride.

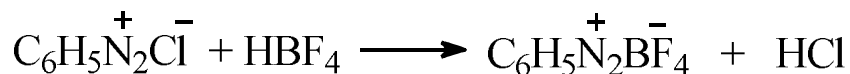

Fluoboric Acid

Diazonium
Fluoroborate
(insoluble)

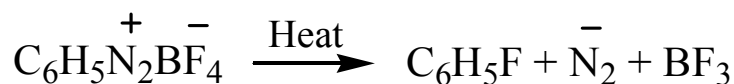

Fluorobenzene

The reaction proceeds by SN^1 mechanism.

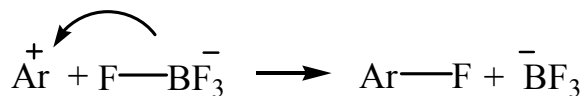
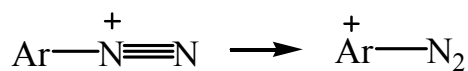

3. **Replacement by aryl group:** Diazonium salt react with other aromatic compounds in the presence of NaOH to give diphenyl this is known as Gomberg-Bachmann reaction.

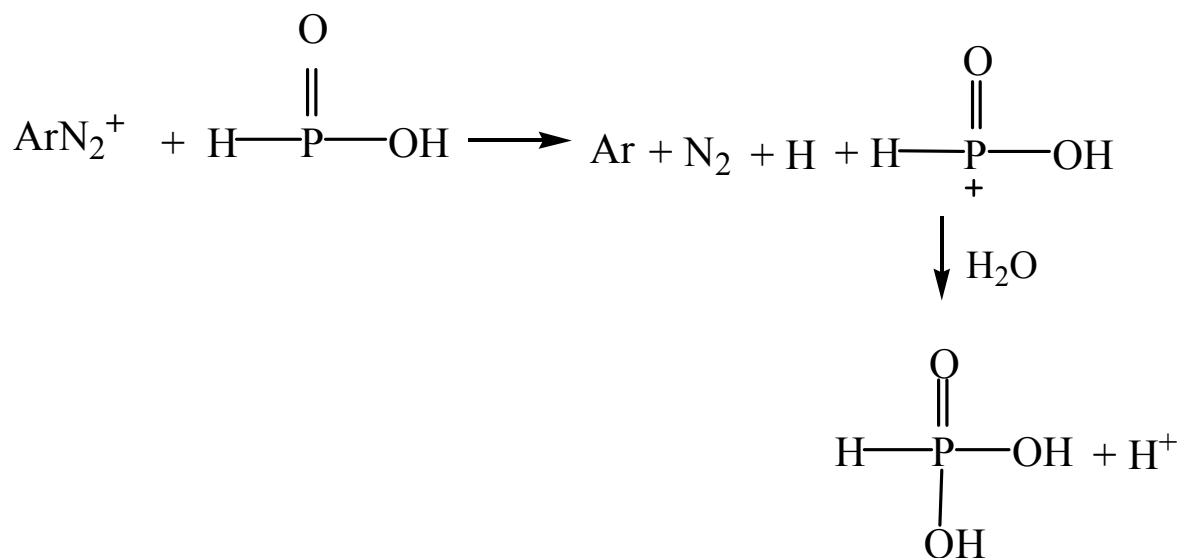

Synthetic utility the reaction of first convenient method of removing an $-\text{NH}_2$ or a $-\text{NO}_2$ group from an aromatic ring.

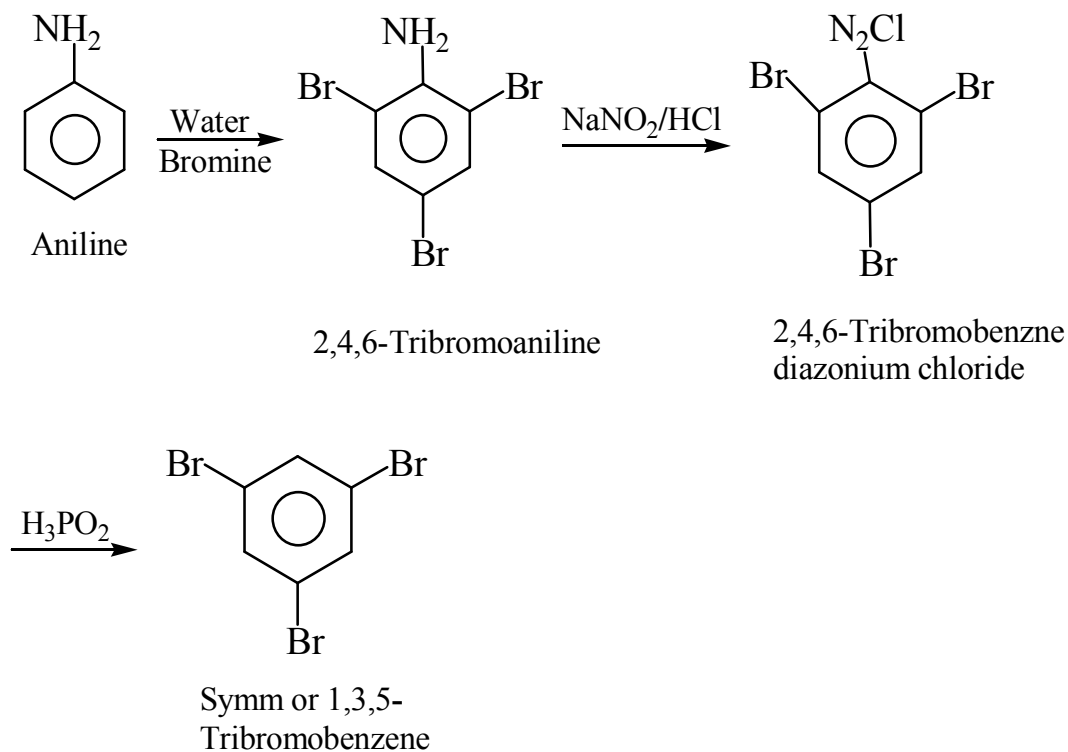

5. **Coupling reaction:** It is an important reaction of diazonium salt and involves reaction of diazonium ions which act as electrophile agents with aromatic compounds containing strong electron releasing groups such as $-\text{OH}$, $-\text{NHR}$ and $-\text{NHR}_2$ to the reaction is known as coupling reaction and leads to the formation of compounds having the general formula.

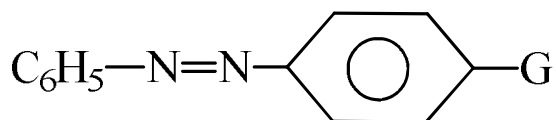

Where G is one of above mentioned electron releasing groups, Coupling reaction in general may be written as.

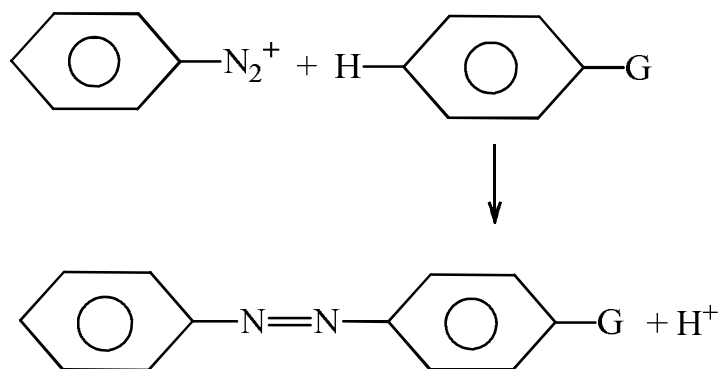

A. **Coupling with phenol:** Benzene diazonium salt react with phenol in weakly alkaline solution to form hydroxy azo compound.

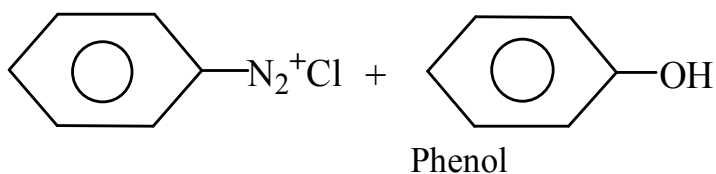

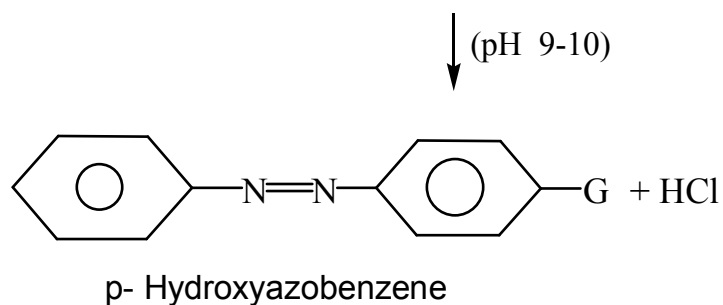

B. **Coupling with tertiary amine:** This coupling takes place in acidic solution. Diazonium salt reacts with tertiary amine to form dialkyl amino azo compound.

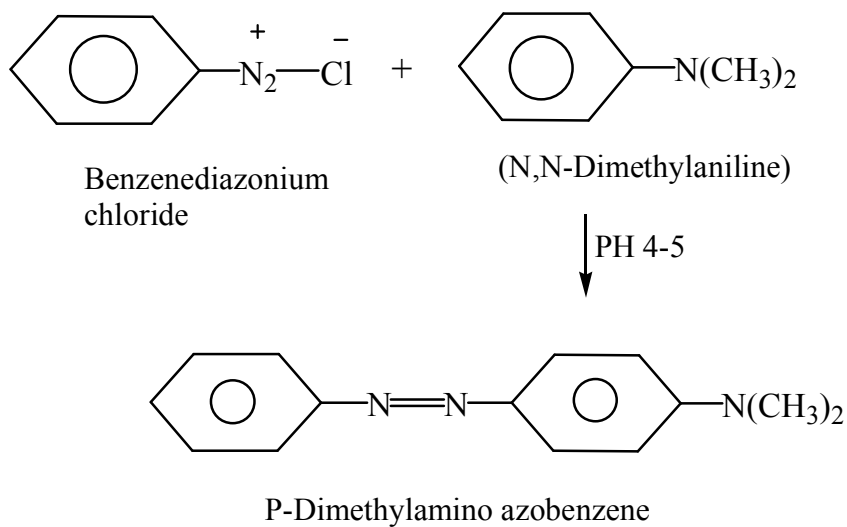

The mechanism of the reaction is as follows.

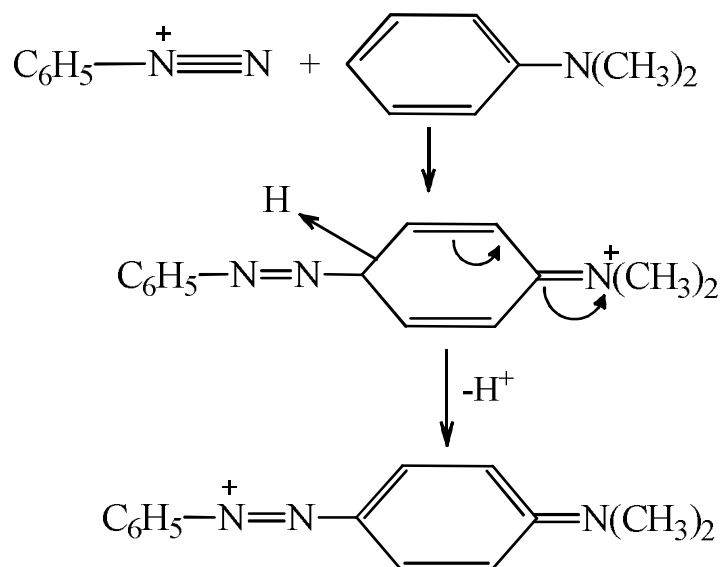

6.25 Diazomethane

Structure

It exist as a resonance hybrid of two structure

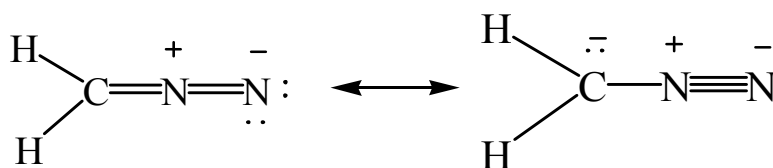

Method of preparation

(i) It can be obtained from N- nitro so -N- methyl compound as shown below.

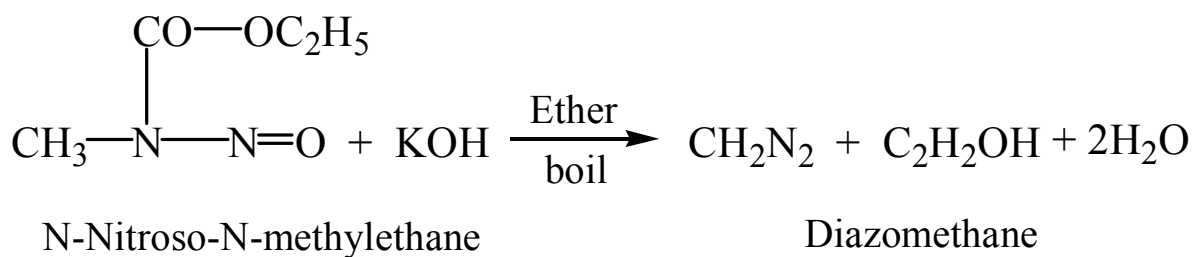

Property of diazomethane

1. **Action of heat** when heated for exposed of light in the composites to form methylene.

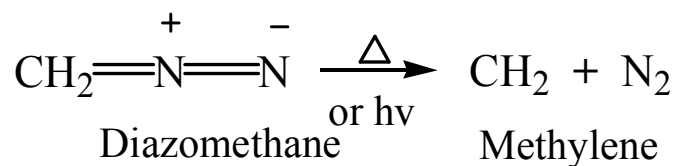

Methylene is very reactive and adds to alkanes to form homogenous alkanes.

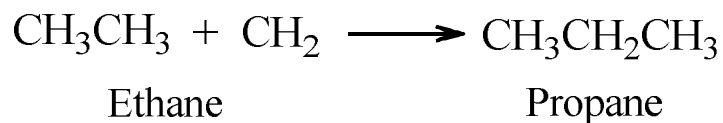

2. **Reduction** on treatment with Na / Hg, it gives methyl hydrazine

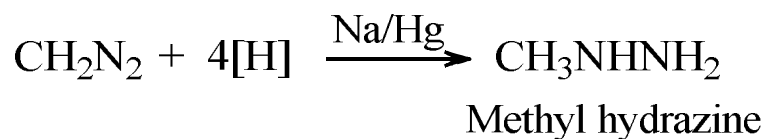

3. **Reaction with mineral acid**



4. **Ring Expansion** cyclohexanes react with diazomethane to produce cycloheptanone.

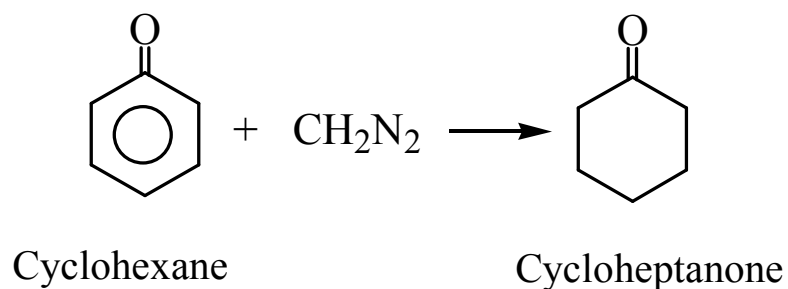

5. **Reaction with carbonyl compounds** diazomethane convert aldehyde into ketones while ketones are converted into higher homologues

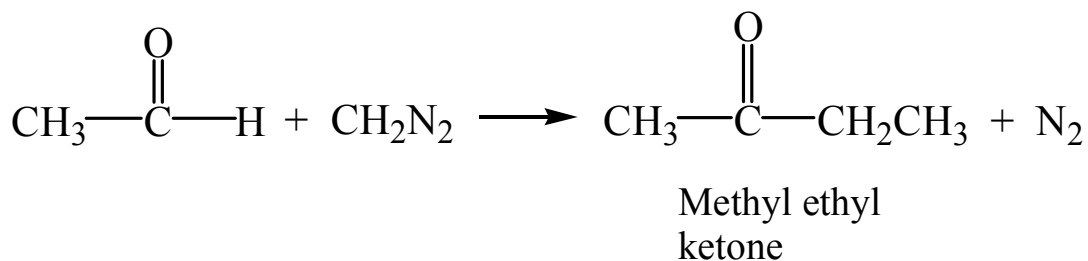
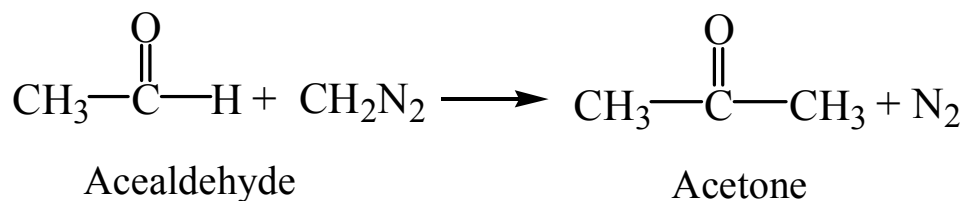

6. **Reaction with phenol** On treatment with diazomethane, phenol gets methylated.

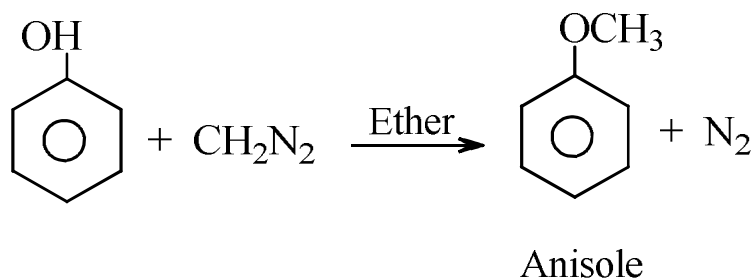

Short answer questions

1. Complete the following reaction

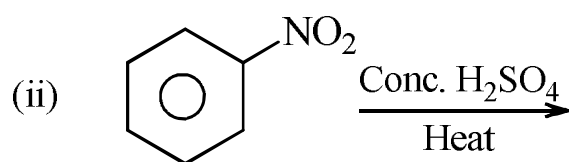
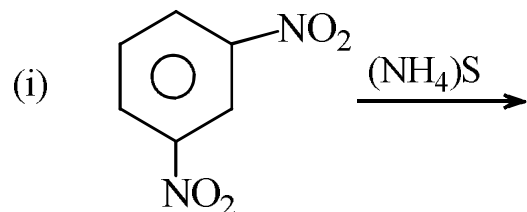

2. What do you understand by vapour phase nitration of alkanes? What are its limitations?

3. How can ortho nitro toluene be prepared from toluene?

4. Complete the following:

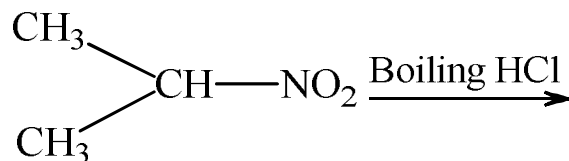

5. Give a suitable mechanism for the following transformation?

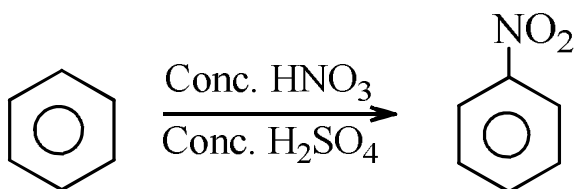

6. Outline the reduction of nitrobenzene in acidic, neutral and alkaline medium?
7. Reduction of nitrobenzene under different condition yields different product. Give three examples?
8. Nature of reduction product of nitrobenzene depends upon the pH value of the medium of reduction and on the nature of the reduction agent elaborates.
9. Write a short note on the tautomerism shown by nitroalkanes.
10. Explain the direction of nitroalkanes in acidic and neutral media separately?
11. Give the method of preparation of picric acid. Why it does not act as strong acid?
12. Give mechanism of Nitration of benzene, also name the electrophile involved in the reaction?
13. Give two method of preparation of nitrobenzene.
14. Discuss discuss selective reduction of m-dinitrobenzene?
15. Give the mechanism of Nitration of benzene?
16. Give a suitable mechanism for the following reaction

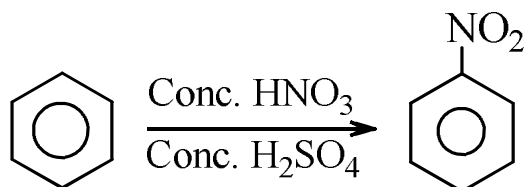

6.26 Terminal Question

1. Discuss with equation five different chemical properties of aromatic nitro compounds?
2. Explain why nitrobenzene undergoes electrophilic as well as nucleophilic substitution?
3. Give the reduction of nitrobenzene in acidic neutral and alkaline media?
4. What products are formed when nitrobenzene is produced under different condition? Give necessary questions.
5. What are nitroalkanes? How are they classified? Give their important methods of preparation?

6. State to the justify the effect of nitro group of the reaction of halogens in aromatic nitro compounds?
7. Discuss the behaviour of aromatic nitro compounds on reduction by considering the case of nitrobenzene.
8. Give the main chemical reaction of nitroalkanes?
9. Describe the method of preparation and chemical reaction of picric acid.

Short Answer Question

1. Draw structure and give the names of various isomers of the formula C_7H_9N containing a benzene ring, how would you distinguish them from one another?
2. Write equation for each of the following reaction?
 - a. Aniline + H_2SO_4 + heat.
 - b. Dimethylamine + $NaNO_2$ + HCl .
3. What are primary, secondary and tertiary amines?
4. Write mechanism; write down the reaction of aniline with the following?
 - a. An aqueous solution of bromine
 - b. Acid chloride
 - c. Chloroform and KOH
5. Starting from aniline how will you obtain?
 - a. Sulphanilic acid
 - b. p-Nitroaniline
6. Write short note on:
 - a. Carbylamine reaction.
 - b. Hoffmann bromamide reaction.
 - c. Gabriel phthalimide reaction.
7. Write short notes on Heisenberg method of separation of 1, 2, 3 amines.

8. Discuss the orientation of electrophilic substitution of aniline in terms of relative stability of intermediate formed.
9. How can you differentiate between primary, secondary and tertiary amines?
10. Write equation if any if each of the following with n-butyl amine?
- HCl
 - CH_3COCl
 - CH_3I
 - $\text{C}_6\text{H}_5\text{SO}_2\text{Cl} + \text{NaOH}$
 - Final product of (1) + moist Ag_2O
11. Arrange the following pairs of substance in order of expected strength show your reasoning?

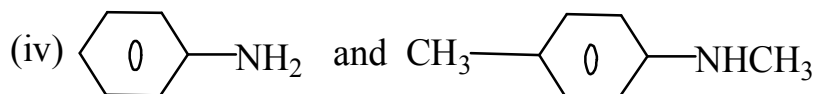
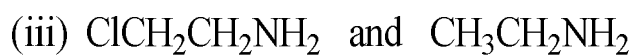
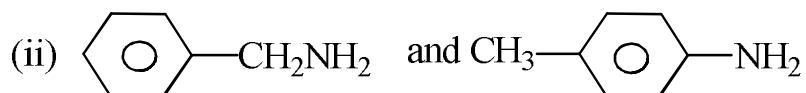
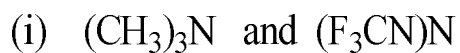

Short answer

1. Complete the following equation?

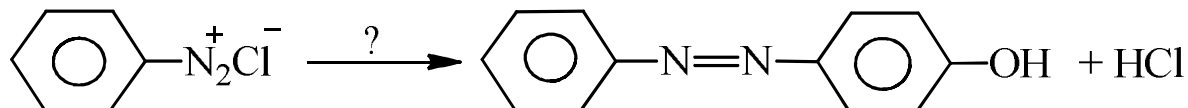

2. Starting from benzene, outline the synthesis of m-bromophenol?
3. Why diazotization is always carried below 5° Celsius?
4. Convert nitrobenzene into m bromophenol?
5. How will you prepare iodobenzene from benzene diazonium chloride?
6. What are diazonium salts? Why are they so named?
7. Give one example of Gomberg-Bachmann reaction?
8. Complete the following reaction

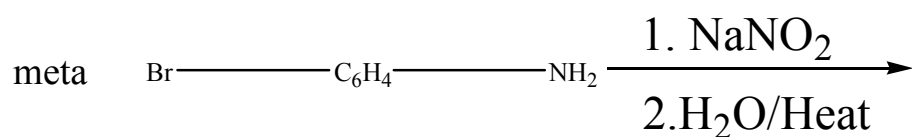

9. How would you prepare
 - i. Benzonitrile from aniline
 - ii. p-Nitroaniline starting from aniline
10. Discuss the role of PH in the coupling reaction of diazonium salt?
11. Write the product in the reaction of Benzene diazonium chloride with CuCl and phenoxide ion?
12. Write a note on azo coupling?
13. Discuss the mechanism of Diazotization of amines?
14. Discuss the mechanism of coupling reaction?
15. How will you synthesis?
 - i. m-bromophenol from benzene
 - ii. 1,3,5- tribromobenzene from benzene
16. Starting with benzene or toluene, how would you prepare the following compounds by employing the intermediates formation of diazonium salt as one of the steps
 - i. phenol
 - ii. phenylhydrazine

iii. m-bromotoluene

17. Give the reagent and special conditions necessary to convert toluene diazonium chloride into:

- i. Toluene
- ii. o-Cresol
- iii. o-Fluorotoluene
- iv. o-Chlorotoluene

18. Write the equation for the reaction of p-nitro benzene diazonium hydrogen sulphate with:

- i. $\text{HBr} + \text{OH}$
- ii. H_2SO_4
- iii. p-Cresol
- iv. CuCN
- v. KI
- vi. HBF_4 , then heat

19. Write the equation ~~six~~ important synthetic application to benzene diazonium chloride and the products obtained.

20. How will you convert aniline to

- i. syn-Tribromobenzene
- ii. m-Bromophenol
- iii. p-Hydroxyazobenzene

21. Discuss the structure of benzene diazonium chloride.

22. How will you convert diazonium salt into?

- i. Diphenyl
- ii. Phenol
- iii. Benzenol
- iv. Phenyl hydrozine

23. Starting from benzene diazonium chloride. How will you prepare.
- Iodobenzene
 - Phenol
 - Aminoazobenzene
 - Benzene
24. Discuss the mechanism of coupling of diazonium salt with phenol and aniline.
25. What is diazotization? Discuss the structure of benzene diazonium chloride
26. What is Sandmeyer reaction?
27. What is diazotization? Give its mechanism. Discuss the structure of benzene diazonium chloride.
28. Give the synthesis and mechanism of diazotization. Which of the following gives most stable compound on treatment with HNO_2 and why?
 $\text{C}_6\text{H}_5\text{NH}_2$, $\text{C}_2\text{H}_5\text{NH}_2$, o-nitroaniline
29. Complete the following conversions.
- Aniline \longrightarrow 1,3,5 tribromobenzene
- Nitrobenzene \longrightarrow m-bromophenol
30. Give the synthetic application of diazonium salts?

